

FACTORY AUTOMATION

Graphic Operation Terminal GOT2000 Series Wide Model



GOT2000 *Wide*

Graphic Operation Terminal

GLOBAL IMPACT OF MITSUBISHI ELECTRIC



Through Mitsubishi Electric's vision, "Changes for the Better" are possible for a brighter future.

Changes for the Better

"Changes for the Better" represents the Mitsubishi Electric Group's attitude to "always strive to achieve something better", as we continue to change and grow. Each one of us shares a strong will and passion to continuously aim for change, reinforcing our commitment to creating "an even better tomorrow".

Mitsubishi Electric is involved in many areas including the following:

Energy and Electric Systems

A wide range of power and electrical products from generators to large-scale displays.

Electronic Devices

A wide portfolio of cutting-edge semiconductor devices for systems and products.

Home Appliance

Dependable consumer products like air conditioners and home entertainment systems.

Information and Communication Systems

Commercial and consumer-centric equipment, products and systems.

Industrial Automation Systems

Maximizing productivity and efficiency with cutting-edge automation technology.

Our advances in AI and IoT are adding new value to society in diverse areas from automation to information systems. The creation of game-changing solutions is helping to transform the world, which is why we are honored to be recognized in the 2019 'Forbes Digital 100' as one of world's most influential digital corporations.



Established February 2nd 1921 Mitsubishi Electric celebrates 100 years of serving society through practical, innovative technology solving the issues of the day.



Index

1. Overview	04
2. Hardware	06
GT25 Wide Model	06
GT21 Wide Model	08
3. Features	10
4. Specifications	19
5. Product List	23
6. Support	25

- 1
- 2
- 3
- 4
- 5
- 6

Lineup

GT25 Wide

GOT2000 widescreen expands your view

Ethernet (2 ports) RS-232 RS-422/485 CC-Link IE Field Basic Sound output (built-in)

<p style="text-align: center;">NEW</p> <p>12.1 inch</p> <div style="display: flex; align-items: center;"> <div style="background-color: #e91e63; color: white; padding: 5px; margin-right: 5px;">TFT 65536 colors</div> <div style="background-color: #003366; color: white; padding: 5px; margin-right: 5px;">DC</div> </div> <div style="display: flex; align-items: center; margin-top: 10px;"> <div style="background-color: #e67e22; color: white; padding: 5px; margin-right: 5px;">WXGA 1280 x 800</div> <div style="margin-left: 10px;"> <p>GT2512-WXTBD GT2512-WXTSD</p> </div> </div>	<p>10.1 inch</p> <div style="display: flex; align-items: center;"> <div style="background-color: #e91e63; color: white; padding: 5px; margin-right: 5px;">TFT 65536 colors</div> <div style="background-color: #003366; color: white; padding: 5px; margin-right: 5px;">DC</div> </div> <div style="display: flex; align-items: center; margin-top: 10px;"> <div style="background-color: #e67e22; color: white; padding: 5px; margin-right: 5px;">WXGA 1280 x 800</div> <div style="margin-left: 10px;"> <p>GT2510-WXTBD GT2510-WXTSD</p> </div> </div>	<p>7 inch</p> <div style="display: flex; align-items: center;"> <div style="background-color: #e91e63; color: white; padding: 5px; margin-right: 5px;">TFT 65536 colors</div> <div style="background-color: #003366; color: white; padding: 5px; margin-right: 5px;">DC</div> </div> <div style="display: flex; align-items: center; margin-top: 10px;"> <div style="background-color: #7ed321; color: white; padding: 5px; margin-right: 5px;">WVGA 800 x 480</div> <div style="margin-left: 10px;"> <p>GT2507-WTBD GT2507-WTSD</p> </div> </div>
---	---	---

GT21 Expands possibilities of GT21 models Wide

Ethernet RS-232 RS-422/485 CC-Link IE Field Basic

7 inch

TFT
65536
colors

DC

WVGA
800 x 480

GT2107-WTBD
GT2107-WTSD

GT Works3 HMI/GOT Screen Design Software

Professional designs in just a few clicks

You can design GOT widescreens with GT Works3, familiar software that can be commonly used for the GOT2000 Series.

GOT Screen Design Software
MELSOFT GT Works3



Widen Your View

Actual size

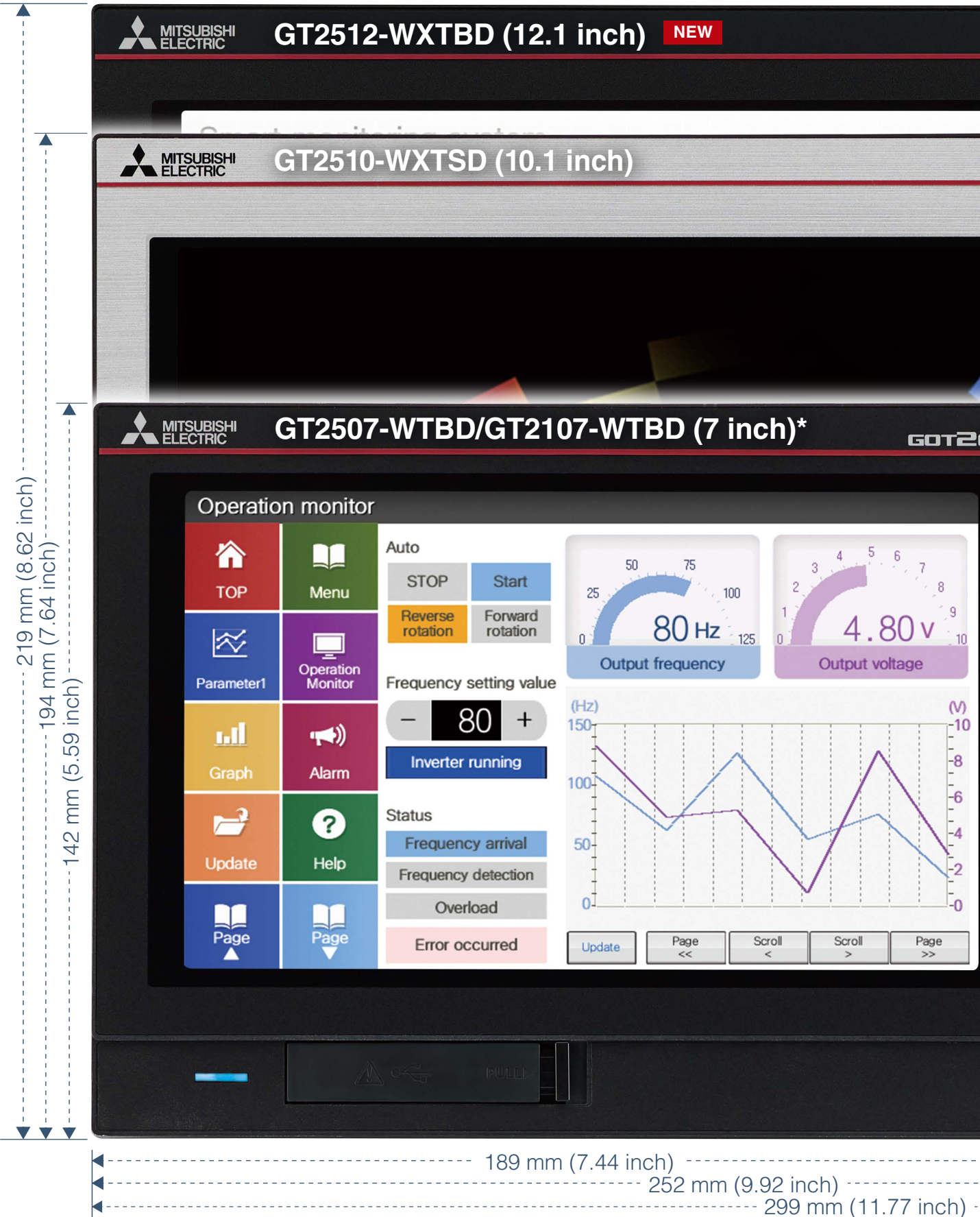

The widescreen elegant body style presents a large amount of information with a high picture quality

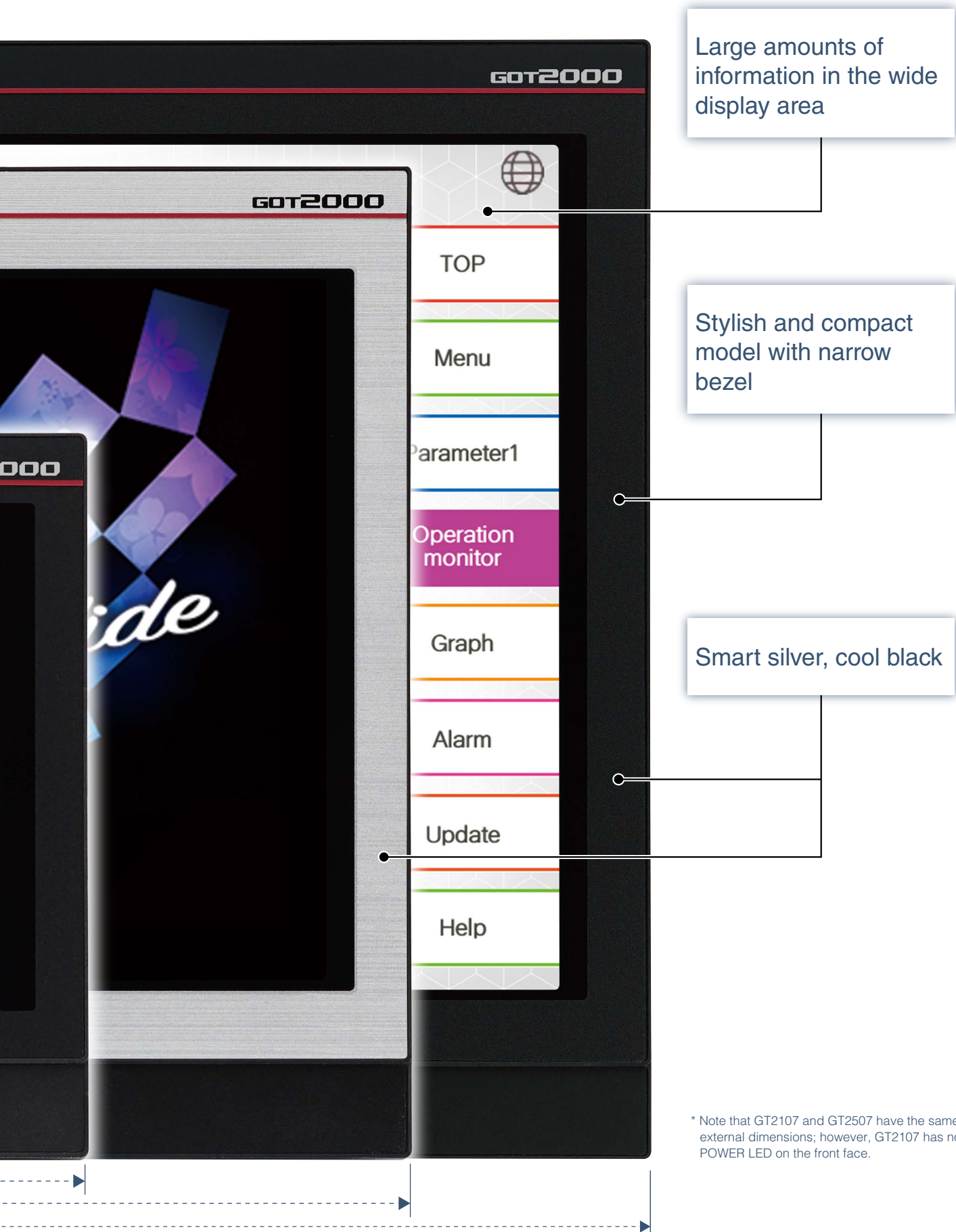

Large amounts of information in the wide display area

Stylish and compact model with narrow bezel

Smart silver, cool black

* Note that GT2107 and GT2507 have the same external dimensions; however, GT2107 has no POWER LED on the front face.

GT25 wide model

GOT2000 widescreen expands your view

For details

Concept movie



2

Hardware

NEW GOT



Various interfaces are equipped in a compact body

The stylish design realized with a narrow bezel. The GOT2000 wide models are available in a choice of silver and black.

Two Ethernet ports and the built-in sound output interface* equipped as standard add value to your system.

* A speaker with built-in amplifier is required separately.

Item	Specifications
Display	7" widescreen/10.1" widescreen/12.1" widescreen NEW , TFT color LCD, 65536 colors
Resolution	7": WVGA, 10.1": WXGA, 12.1": WXGA
Backlight	White LED
User memory	Memory for storage (ROM): 32 MB Memory for operation (RAM): 128 MB
Standard interface	Ethernet (2 ports), RS-232, RS-422/485 USB host (USB-A): 1 channel (USB 2.0 (High-Speed 480 Mbps)) USB device (USB Mini-B): 1 channel (USB 2.0 (High-Speed 480 Mbps)) Sound output interface (φ3.5 minijack), SD memory card interface
Extension interface	-
Wireless LAN communication unit interface	For installing a wireless LAN communication unit

Ultra high resolution display improves expressiveness

Ultra high resolution WXGA screen* displays necessary and sufficient information on one screen. Small characters can be displayed clearly.

* WXGA display on the 10.1 inch and 12.1 inch models. WVGA display on the 7 inch model.

About 3.3 times higher resolution displays small characters clearly

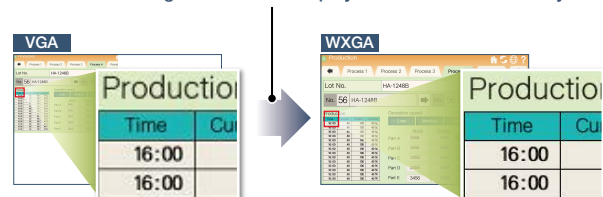

* The example image shows the 10.1 inch model.

Add value to your system with sound notification

The built-in sound output interface makes it easy to implement the sound notification system (page 12, page 13). Not only by displaying the contents of events on the screen but also by notifying with sound, you can convey the necessary information to the operators.

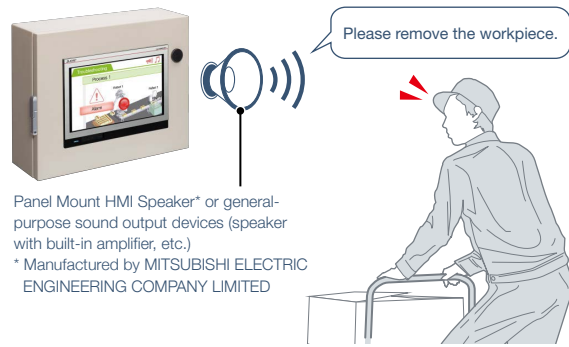

Enable separation of information and control system networks

Two Ethernet ports physically separate the information system network in the office from the control system network at the production site. The network architecture becomes safer and more secure by setting different IP addresses for each network.

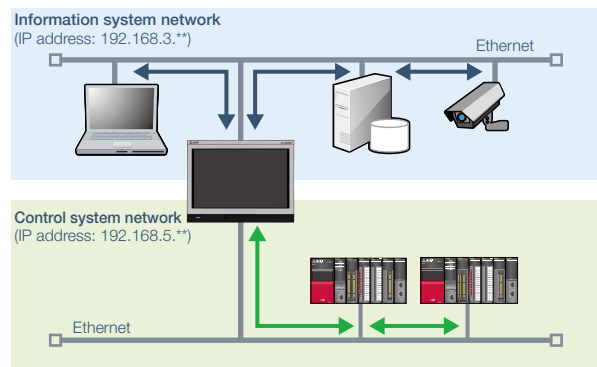

GT25 wide model external appearance [front face/rear face] * The example picture shows the 10.1 inch model.



1 USB interface: device (USB Mini-B)

Connect to a personal computer and transfer data.

2 USB interface: host (USB-A)

Transfer project data or read the data (logging data, etc.) to or from the GOT using the USB memory. A USB mouse, keyboard, barcode reader*, or RFID reader* can also be connected.

* USB keyboard (HID) compatible model only

3 Ethernet interface (2 ports)

Use Ethernet to simultaneously connect up to four types of industrial devices from different manufacturers. CC-Link IE Field Network Basic compatible devices can also be connected.

4 RS-422/485 interface

Connect to various industrial devices and barcode readers.

5 RS-232 interface

Connect to various industrial devices, barcode readers and serial printers.

6 Sound output interface (φ3.5 minijack)

Output sound by connecting φ3.5 stereo mini-plug (3-prong).

7 SD memory card interface

Save large volumes of data, including alarms and logging data.

8 Wireless LAN communication unit interface

Install a wireless LAN communication unit.

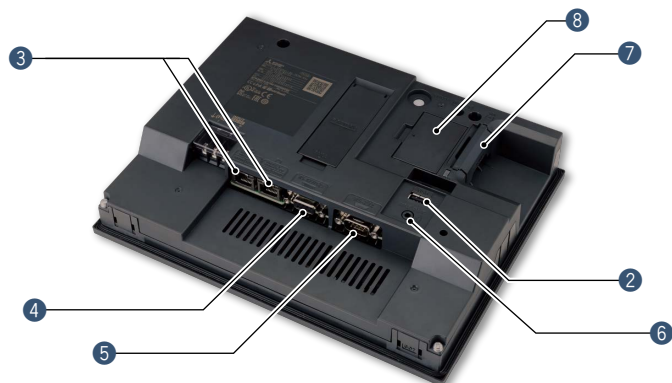

GT21 wide model

Expands possibilities of GT21 models

For details

Concept movie

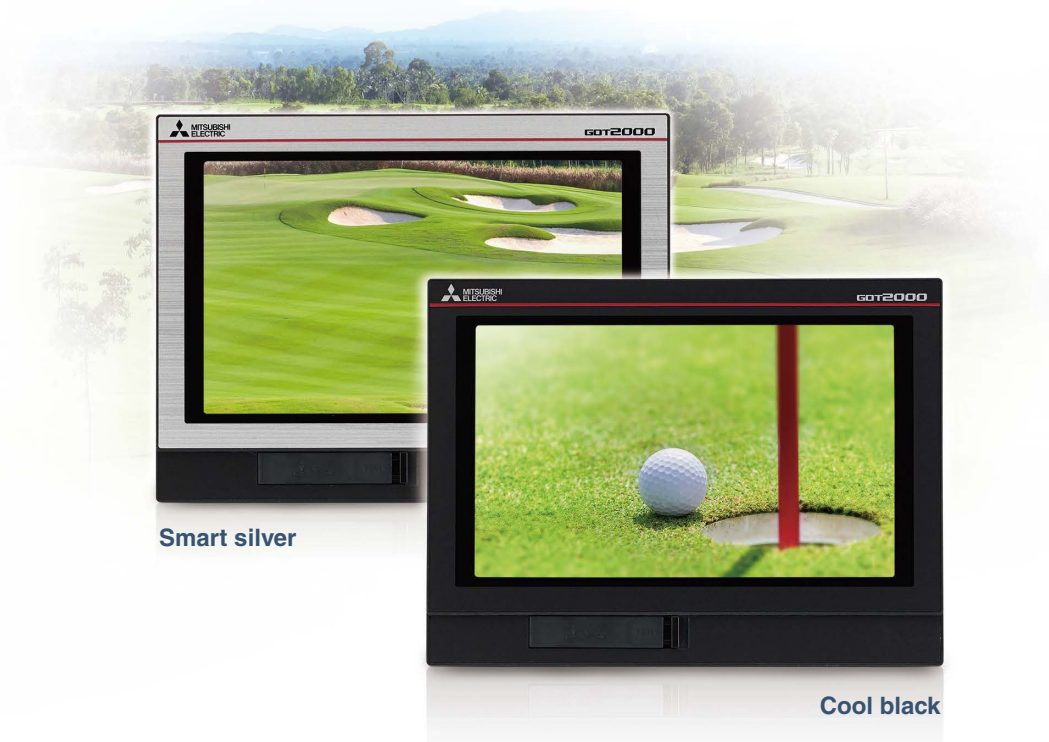

Smart silver

Cool black

The highest resolution screen in the GT21 models, with various built-in interfaces

The GOT2000 wide models are available in a choice of silver and black. In addition to the high resolution display, 65536 colors of LCD improves quality of screen display.

The first GT21 model with the USB host enables you to connect a USB mouse and keyboard, or transfer data using a USB memory. In addition, Ethernet printers can be used.

Item	Specifications
Display	7" widescreen, TFT color LCD, 65536 colors
Resolution	WVGA
Backlight	White LED
User memory	Memory for storage (ROM): 15 MB
Standard interface	Ethernet, RS-232, RS-422/485 USB host (USB-A): 1 channel (USB 1.1 (Full-Speed 12 Mbps)) USB device (USB Mini-B): 1 channel (USB 1.1 (Full-Speed 12 Mbps)) SD memory card interface

Widescreen displays large amounts of information

High resolution WVGA screen has sufficient display area for long alarm messages.

5 times higher resolution greatly increases expressiveness

Standard GT1055-Q

QVGA 320 x 240 dots



Wide GT2107-W

WVGA 800 x 480 dots



Remote monitoring provides wide access to application

Remote monitoring with the VNC server function is now available on GT21. By remotely connecting to GOT from personal computer or tablet, you can operate, monitor production equipment and connect to system devices.

* GT2107-W only among GT21 models.



Enhanced graphics

Outline fonts can now be used on GT21 model. Antialiasing smoothes out jagged text edges and displays clear characters, offering improved visibility of screen display.

* GT2107-W only among GT21 models.

Standard 16dot HQ Gothic

Trend graph

Wide Outline Gothic (antialiasing enabled)

Trend graph

Clear characters improve visibility

■ GT21 wide model external appearance [front face/rear face]



1 USB interface: device (USB Mini-B)

Connect to a personal computer and transfer data.

2 USB interface: host (USB-A)

Transfer project data or read the data (logging data, etc.) to or from the GOT using the USB memory. A USB mouse, keyboard, barcode reader*, or RFID reader* can also be connected.

* USB keyboard (HID) compatible model only

3 Ethernet interface

Use Ethernet to simultaneously connect up to two types of industrial devices from different manufacturers. CC-Link IE Field Network Basic compatible devices can also be connected.

4 RS-422/485 interface

Connect to various industrial devices and barcode readers.

5 RS-232 interface

Connect to various industrial devices, barcode readers and serial printers.

6 SD memory card interface

Save large volumes of data, including alarms and logging data.

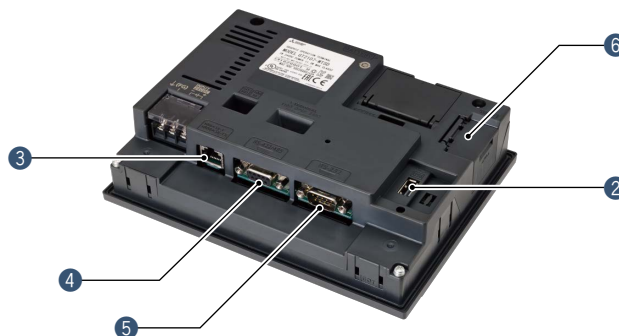

Improve visibility and operation of your application with GOT wide model

The GOT wide model has various advantages and benefits

The greater amount visual information, the higher productivity



✔ GT25 Wide ✔ GT21 Wide

Increase the graph display area

Before

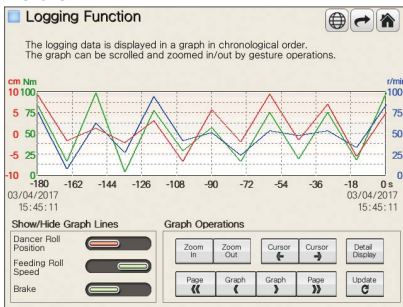

Can I check more information in a graph on a single screen?

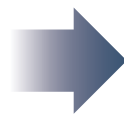

On wide model

After

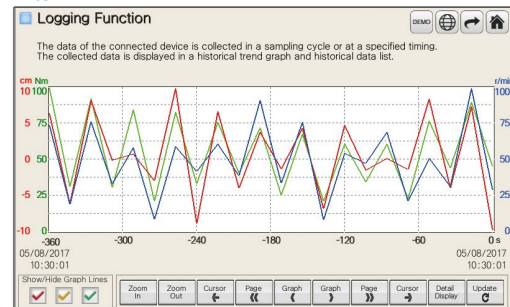

The wider graph display area enables you to check a large amount of logged trend data.

Increase alarm information

Before

Occurred	Message	Rest.
3/ 4/2017 15:46:44	Parameter error	15:46
3/ 4/2017 15:46:44	Fuel error	15:46
3/ 4/2017 15:46:44	Internal pressure error	15:46
3/ 4/2017 15:46:44	Timing belt fault	15:46
3/ 4/2017 15:46:44	Apparatus life	15:46
3/ 4/2017 15:46:44	Oil pressure error	15:46
3/ 4/2017 15:46:44	Battery error	15:46
3/ 4/2017 15:46:44	Fuse error	15:46
3/ 4/2017 15:46:44	Parameter error	15:46

Can I check more alarms on a single screen?



On wide model

After

Occurred	Message	Rest.
03/04/2017 15:45:59	Parameter error	15:45
03/04/2017 15:45:59	Fuel error	15:45
03/04/2017 15:45:59	Internal pressure error	15:45
03/04/2017 15:45:59	Timing belt fault	15:45
03/04/2017 15:45:59	Apparatus life	15:45
03/04/2017 15:45:59	Oil pressure error	15:45
03/04/2017 15:45:59	Battery error	15:45
03/04/2017 15:45:59	Fuse error	15:45
03/04/2017 15:45:59	Parameter error	15:45
03/04/2017 15:45:59	Fuel error	15:45
03/04/2017 15:45:59	Internal pressure error	15:45
03/04/2017 15:45:59	Timing belt fault	15:45
03/04/2017 15:45:59	Apparatus life	15:45
03/04/2017 15:45:59	Oil pressure error	15:45

Move the operation menu to the side of the widescreen and you can check more alarms.

Always show numeric keypad

Before

Time	Current	Predicted	Achieved	Operation speed
15:48	3456	3456	3456	Low Medium High
15:48	3456	3456	3456	
15:48	7	8	9	AC
15:48	4	5	6	DEL
15:48	1	2	3	E N T
15:48	0	+/	-/	

Can I avoid hiding the information every time I enter a value to a numerical input?

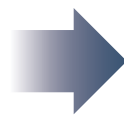

On wide model

After

Time	Current	Predicted	Achieved	Operation speed	Manual Run	Auto Run
15:49	3456	3456	3456	Low Medium High		
15:49	3456	3456	3456			
15:49	3456	3456	3456			
15:49	3456	3456	3456			
15:49	3456	3456	3456			
15:49	3456	3456	3456			
15:49	3456	3456	3456			
15:49	3456	3456	3456			
15:49	3456	3456	3456			

Put the numerical keypad on the base screen and operate the screen while viewing necessary information.



Improve operability by always displaying the menu

✔ GT25 Wide ✔ GT21 Wide

Quickly change screens from every display screen

Before

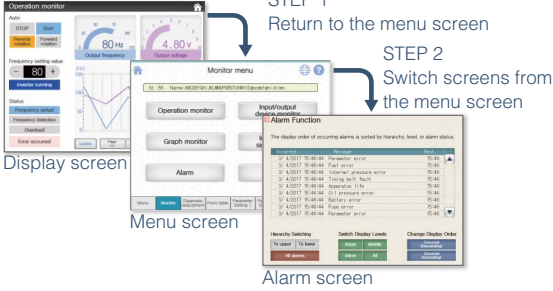

On wide model

After

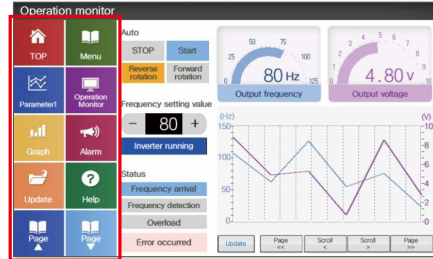

Arrange the menu on the side of the widescreen and switch screens with just one touch operation.

Do I always have to return to the menu screen?

Display the whole page vertically using the document display function

✔ GT25 Wide □ GT21 Wide

View the whole page on one screen

Before

VGA

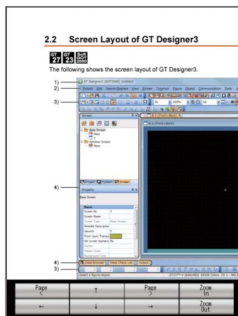

The necessary information is not displayed on one page. It is troublesome to scroll the page...

On wide model

After

WXGA

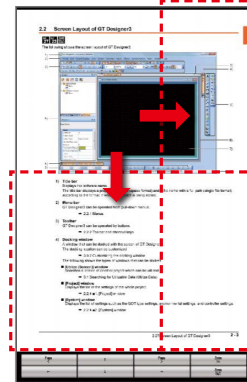

Display the whole document page and check the information quickly.

Install GOT in confined spaces

✔ GT25 Wide ✔ GT21 Wide

Downsize the operation panel



On wide model



The compact body can be installed vertically and enables downsizing of the machine.

Convey information easily and reliably with sound

GT Works3 can now be used to synthesize speech data. Sound files can be created easily.



Support sound file creation

GT25 Wide GT21 Wide

Speech synthesis function*1

Just enter text in GT Works3 to create a sound file of a message. (Up to 500 files can be registered.) Messages can be created in 6 languages and you can select the speaker (female/male) for each language. In addition, using FA Term Translation Tool*2 together can reduce time for multi-language screen creation and support globalization of the system.

*1 GT Works Text to Speech License (SW1DND-GTVO-M) is required separately.
*2 This tool is included with GT Works3. For the details, please refer to page 18 or contact your local sales office.

Supported language

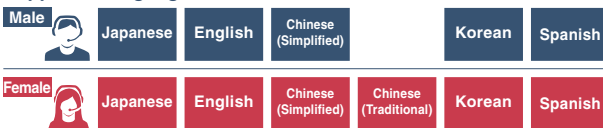
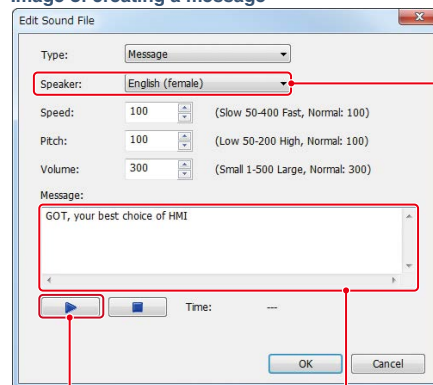

Image of creating a message



Select language and gender of speaker

Playback and check the sound

Enter an arbitrary message

Enhanced playback functions of sound files

GT25 Wide GT21 Wide

Multiple files can be set and played back consecutively (up to 16 files). The playback time is now longer than before so that various messages can be used.

Sound file specifications

Item	Specifications
Sound file format	WAV format
Sampling frequency	8.000 kHz/16.000 kHz
Channel number	1 channel (monoral)
Maximum playback time	30 seconds per file 480 seconds for consecutive playback (up to 16 files)
Consecutive playback (by switch or trigger action)	Up to 16 files can be set
Playback specifications	Mute/cancel is supported

Cancel or mute the sound while it is being played back

After checking the situation, you can stop or mute the sound while it is being played back so that you do not need to worry about annoying other operators.



Easily set consecutive playback list (by switch operation or trigger action)

In GT Works3, just specify the files in the playlist in the order of your preference and the files are played back consecutively.

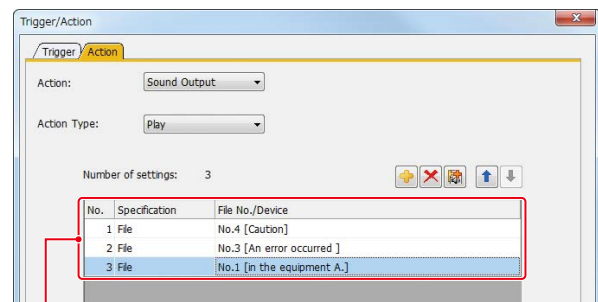

By setting actions, the sound files are played back in the order specified in the list. Up to 16 sound files can be specified.



Specification details and restrictions

For the supported connection types and necessary option devices, please refer to the relevant product manual.

Sound notification is useful at the worksite

GT25 Wide GT21 Wide

Use message, sound effect, or melody to notify occurring events

When an alarm occurs, outputting a warning message or a warning sound can reliably convey the information to the operators who are working away from the GOT. It is also usable while screen saver is active. Quickly notify the alarm information and the error cause of the equipment to reduce the downtime of the system.

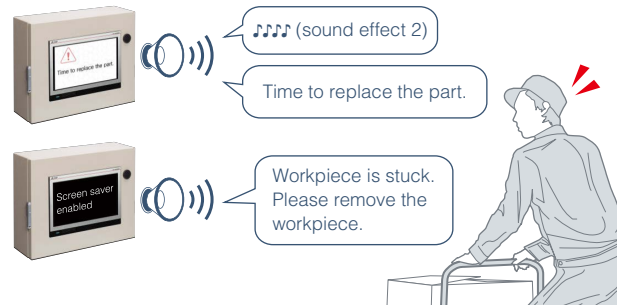

Playable sound file types

Message	Sound effect	Melody
Create from arbitrary text	More than 50 files are included	More than 10 files are included

Additional functions

GT25 Wide GT21 Wide

Even if multiple errors occur, playback all messages

If multiple errors occurred simultaneously, GOT saves up to 16 data and notify all events. There is no need to worry about missing some occurred events.

Even if multiple errors occur simultaneously...

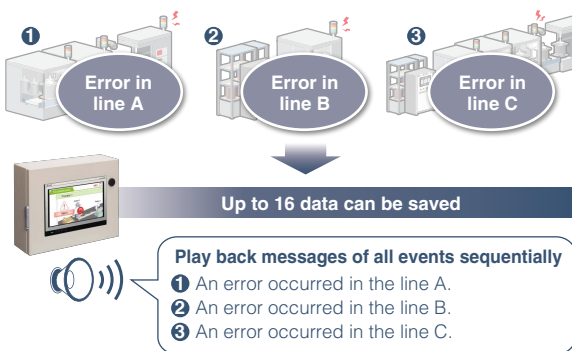

Consecutive playback reduces data size

You can extract common parts and register them as separate sound data to avoid saving duplicate data and reduce data size. To change messages, simply change the combination.

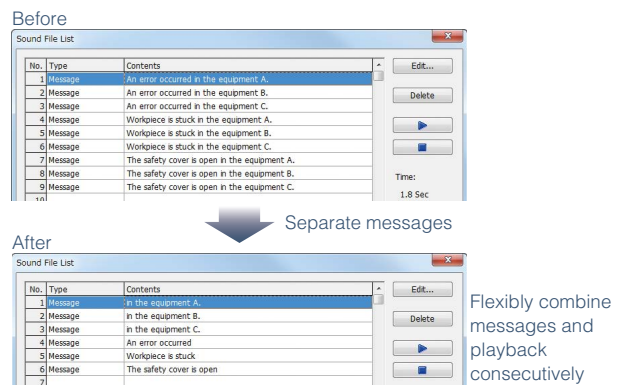

Useful tips about using sound notification

GT25 Wide GT21 Wide

Change touch sound depending on the situation

The touch sound can be changed depending on the worksite situation or the operator's preference.

Touch sound for various situations



Touch sound for each operator

Preferred touch sound can be set.

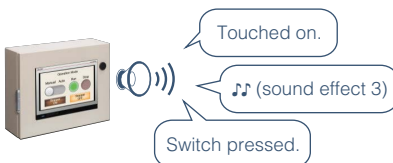

Use as the sound guidance when touching a switch

When touching a switch, a message guides you to the next operation and notifies cautions so that you can avoid operation mistakes in advance.

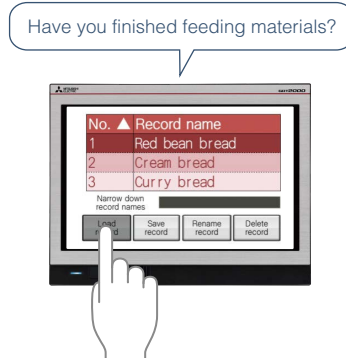

Announce a message in various languages sequentially

When there are operators who understand different languages, you can convey necessary information correctly to every operator.



Specification details and restrictions

For the supported connection types and necessary option devices, please refer to the relevant product manual.

GOT Web-based Remote Solutions

The GOT2000 improves visualization accessibility and reduces total cost of ownership

For the details, please refer to the following catalogs.

- GOT Web-based Remote Solutions Leaflet (L(NA)08399ENG)
- GOT2000 Series GOT Mobile Function Application Examples (L(NA)08464ENG)



Monitor your worksite from a remote location

GT25 Wide GT21 Wide

GOT Mobile function

Via GOT at the worksite, monitor the connected devices from computers and tablets in a remote location. By creating screens of different sizes depending on the device to use, you can display only necessary information in an easy-to-view layout.

- * A separate license (GT25-WEBSKEY-□) is required.
- * Up to five clients can connect to one GOT at the same time.
- * Web browser (Google Chrome or Safari) is required on the client.

Monitor at the production site, from inside or outside the office simultaneously

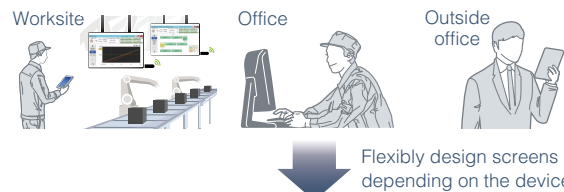

Adjust and start up production by up to five operators simultaneously without worrying about simultaneous operations

Up to five information devices (clients) can simultaneously access a single GOT. Exclusive control of authorization prevents conflicts between the on-site GOT and remote access device. (GOT network interaction)



*1 For the countries where the unit can be used and other details, please refer to the "Product list" (page 23).

Application examples

GT25 Wide GT21 Wide

Quickly check the necessary information and reduce downtime

Prepare necessary manuals, web sites, and movie manuals in advance and you can check the information you need on tablets. (Hyperlink function)

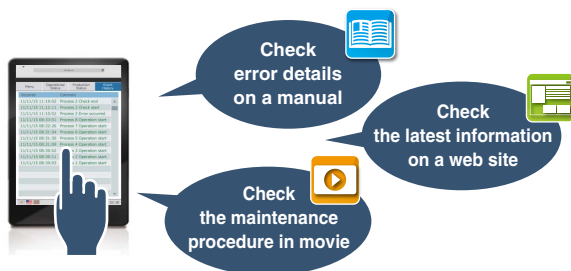

Specification details and restrictions

For the supported connection types and necessary option devices, please refer to the Graphic Operation Terminal GOT2000 Series/ GOT SIMPLE Series Catalog (L(NA)08270ENG) or the relevant product manual.

Implement the ANDON system easily

Use GOT with a large screen monitor and a personal computer and you can implement the ANDON system. Each monitor can display a different initial screen just by turning on the power of the system. (ANDON function)

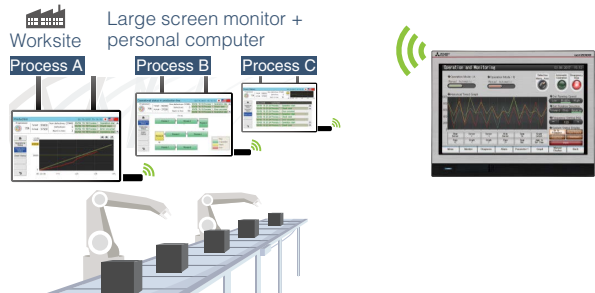

GOT Drive Control Interactive Solutions

Support startup, adjustment of servo systems with advanced functionality and improved connectivity

For the details, please refer to the following catalog.
 •GOT2000 Drive Control (Servo) Interactive Solutions catalog (L(NA)08335ENG)

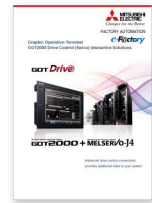

Support startup, adjustment, and maintenance of servo systems GT25 Wide GT21 Wide

Drive control interactive functions

The GOT2000 provides major functions of MR Configurator2 (supporting MR-J5, MR-J4, and MR-JE). The GOT Drive enhanced functionality is designed to eliminate need for additional hardware, software and suits customers' applications to speed up system startup, improve maintenance and troubleshooting.

System configuration example

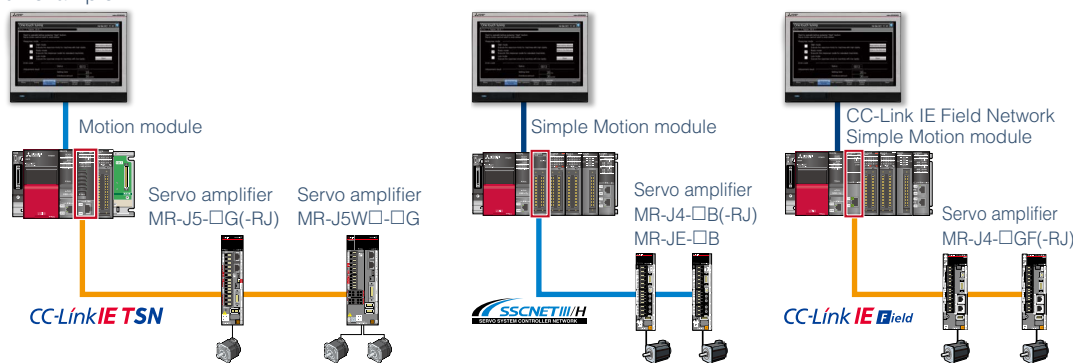

Check the status of servo amplifier

The system launcher function supports SSCNET III/H. A graphical configuration diagram indicates the status of servo amplifier so that you can quickly identify the error cause and solve the problem. The drive recorder function can be started from the configuration diagram screen.

* Not supported by GT21.
 * The system launcher for MR-J5 will be supported soon.

System launcher function

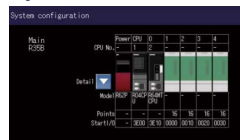

Display the serial number of servo amplifier and motor. File output is also supported.

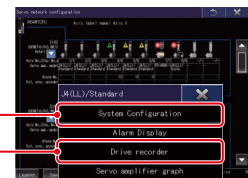

Select a servo amplifier and analyze the waveform in the drive recorder function.

Support preventive maintenance of a servo system GT25 Wide GT21 Wide

Machine diagnosis function

GOT displays the screen equivalent to the machine diagnosis of MR Configurator2 maintenance function. In addition, GOT can be used to log estimation values of servo amplifier and set threshold values so that you can compare these values to predict machine deterioration and make preventive maintenance easy.

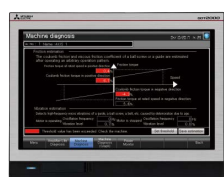
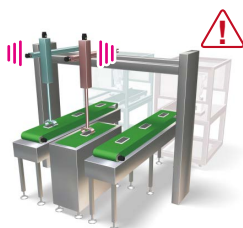

Perform preventive maintenance before the machine stops

Identify error cause of a system problem GT25 Wide GT21 Wide

Drive recorder function

GOT displays the screen equivalent to the drive recorder of MR Configurator2. The data before and after the alarm occurrence can be read from the servo amplifier and displayed in a waveform or a list form so that you can quickly solve the problem.

Drive recorder information list screen

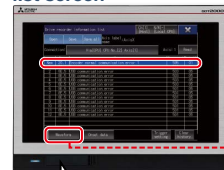

Store the servo data on the GOT's SD memory card or USB memory, and check and analyze in your office.

Graph waveform screen

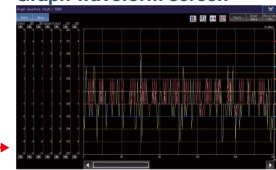

Specification details and restrictions

For the supported connection types and necessary option devices, please refer to the Graphic Operation Terminal GOT2000 Series/ GOT SIMPLE Series Catalog (L(NA)08270ENG) or the relevant product manual.

Easily connect to various industrial devices

Simply connect to various controllers using built-in interfaces of GOT



Built-in interfaces of GOT to connect to various industrial devices

GT25 wide model

* The example picture shows the 10.1 inch model.

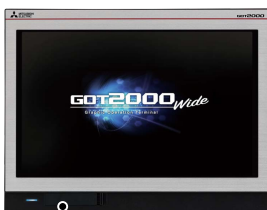

1) USB interface: device (USB Mini-B)

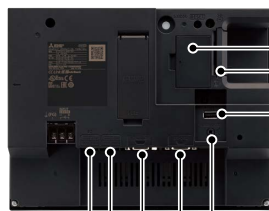
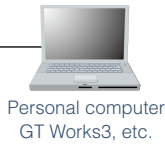

2) Wireless LAN communication unit interface



Wireless LAN communication unit*1 (access point)



*1 For the countries where the unit can be used, please refer to the product list on page 23.

3) SD memory card interface



SD memory card

4) USB interface: host (USB-A)*2

*2 Use the panel-mounted USB port extension cable to route the USB port to the front side of the control panel.



USB (host) compatible devices

5) Sound output interface (φ3.5 minijack)



Panel Mount HMI Speaker*4 or general-purpose sound output devices (speaker with built-in amplifier, etc.)
*4 Manufactured by MITSUBISHI ELECTRIC ENGINEERING COMPANY LIMITED

6) RS-232 interface



Personal computer, industrial devices, serial printer, etc.

7) RS-422/485 interface



Industrial devices, etc.

8) Ethernet interface*3 Port 1

Ethernet

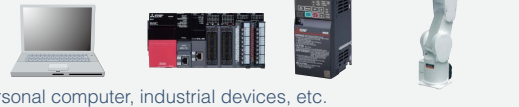

Personal computer, industrial devices, etc.

9) Ethernet interface*3 Port 2

CC-Link IE Field Basic



CC-Link IE Field Network Basic compatible devices

*3 Both Ethernet interfaces (Port 1 and Port 2) can be used to connect to Ethernet compatible devices and CC-Link IE Field Network Basic compatible devices.

GT21 wide model



Specification details and restrictions

For the supported connection types and necessary option devices, please refer to the Graphic Operation Terminal GOT2000 Series/ GOT SIMPLE Series Catalog (L(NA)08270ENG) or the relevant product manual.



Support quick troubleshooting

☑ GT25 Wide ☐ GT21 Wide

CC-Link IE Field Network diagnostics

GOT can be used to check the CC-Link IE Field Network diagnostics screen. The function enables you to identify the error in the network at a glance without using a personal computer. If a problem occurs, you can quickly check where the error occurs, the error cause, and the event history and reduce downtime.

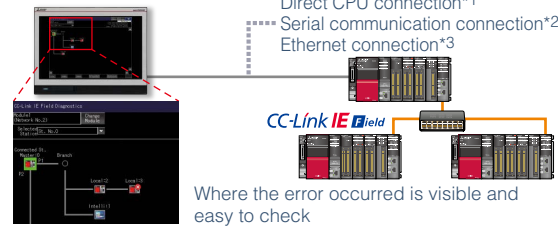

- *1 RCPU and FX5CPU do not support direct CPU connection.
- *2 FX5CPU does not support serial communication connection.
- *3 Connection to the Ethernet interface module of a programmable controller is not supported.

Highly flexible system configuration

☑ GT25 Wide ☑ GT21 Wide

Support CC-Link IE Field Network Basic

Use the standard Ethernet interface and connect GOT with CC-Link IE Field Network Basic compatible devices. Cyclic communication is supported. Ethernet TCP/IP communication can be used together with CC-Link IE Field Network Basic so that you can design more flexible system.

* For the details, please refer to the Technical Bulletin No. GOT-A-0104.

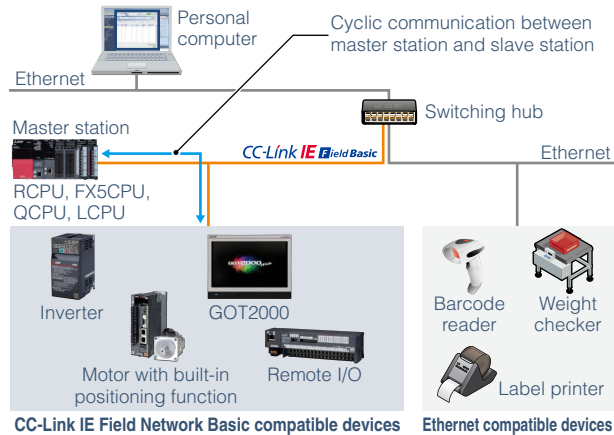

Easy debugging

☑ GT25 Wide ☑ GT21 Wide

FA transparent function

By connecting a personal computer to the front USB interface on the GOT, you can use the GOT as a transparent gateway to enable programming, startup, and adjustment of industrial devices. Users do not have to bother with opening the cabinet or changing cable connections.

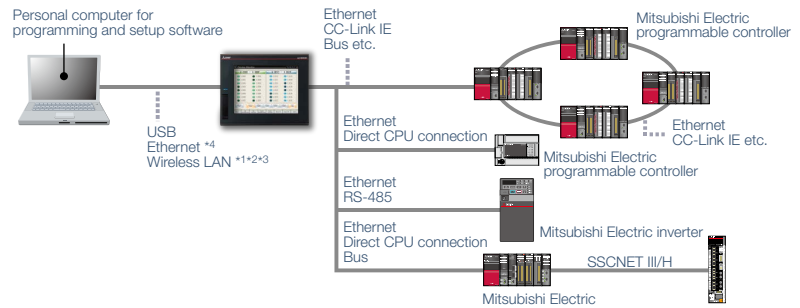

- *1 Not supported by GT2505, GT2505 handy, GT23, GT21.
- *2 Installation of the wireless LAN communication unit (GT25-WLAN) is required on the GOT.
- *3 For the countries where the wireless LAN communication unit can be used and other details, please refer to page 23.
- *4 Not supported by GT2505, GT2505 handy, GT23, and GT21 when the GOT is connected to controllers via Ethernet connection.
- *5 GT21 does not support connection to Mitsubishi Electric servo amplifiers.

Specification details and restrictions

For the supported connection types and necessary option devices, please refer to the Graphic Operation Terminal GOT2000 Series/ GOT SIMPLE Series Catalog (L(NA)08270ENG) or the relevant product manual.

Support screen creation and globalization

Various reuse features help you reduce time for screen creation. A convenient tool will help you more with your multi-language screen creation.

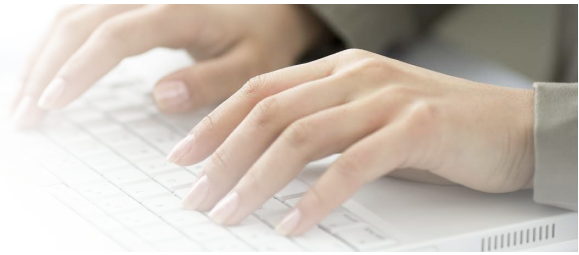

HMI/GOT Screen Design Software

Professional designs in just a few clicks

This integrated software is used to create professional screen designs for GOTs. Developed with the concepts of simplicity, sleekness, and user-friendliness in mind, this is a powerful tool that pushes boundaries and delivers endless design possibilities.

GOT Screen Design Software MELSOFT GT Works3



3 Features

Utilize data (Projects)

Reuse all data from previous projects.

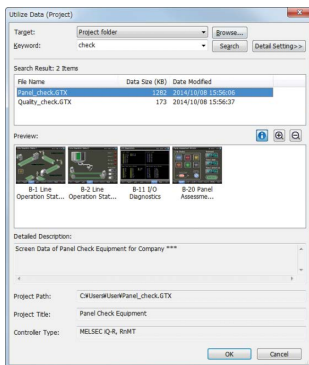

Utilize data (Screens)

Reuse individual screens from past or sample projects. The settings are also applied and reused so that you can create project data easily.



Search by target/category/keyword

Select a search target, category, or keyword and you can quickly find the screen you need.

Category list

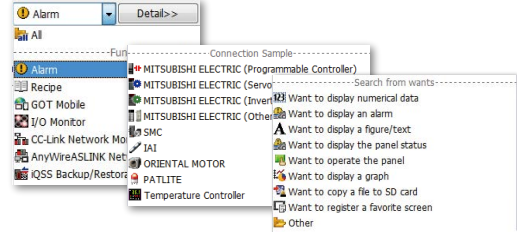

FA Term Translation Tool

This is the software to translate comments (words, sentences) that are used in GT Works3 and other MELSOFT applications using the FA Term Translation Dictionary provided by Mitsubishi Electric. It can be used even if your computer is not connected to the Internet. You can create your own dictionary and switch dictionaries depending on your needs. The software supports creation of multiple language screens.

FA Term Translation Tool

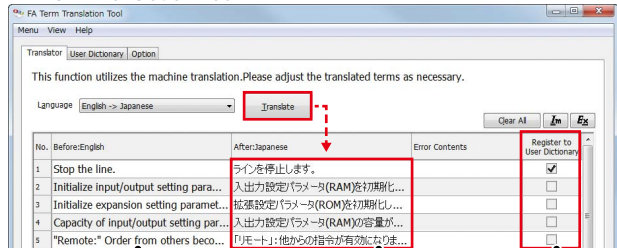

GT Works3

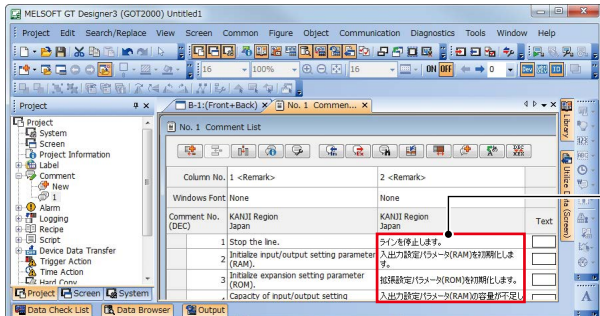

1 Copy comments to translate (e.g. from GT Works3) and paste them to the FA Term Translation Tool window

2 Translate comments

Check a checkbox to save it to the dictionary

3 Copy the translated results and paste them to GT Works3



It is easy to create language switching screens

Specification details and restrictions

For the supported connection types and necessary option devices, please refer to the Graphic Operation Terminal GOT2000 Series/ GOT SIMPLE Series Catalog (L(NA)08270ENG) or the relevant product manual.

Function list

To use new functions, GT Works3 Version 1.250L or later is required. Some functions are supported by GT27 only. For details of functions, supported controllers, and connection types, please refer to the GOT2000/GOT SIMPLE Series Manual or Help.
 ●: Supported —: Not supported ○: Option devices required

Category	Function name	Option devices	GT25		GT21		
			Wide model	Standard model	Wide model	Standard model	
Figure/object functions	Figure		●	●	●	●	
	Logo text		●	●	●	●	
	Outline font		●	●	●	—	
	Touch switch		●	●	●	●	
	Lamp		●	●	●	●	
	Numerical display, Numerical input		●	●	●	●	
	Text display, Text input		●	●	●	●	
	Date display, Time display	*7	●	●	●	●	
	Comment display		●	●	●	●	
	Parts display	*7	●	●	●	●*5	
	Parts movement	*7	●	●	●	●*5	
	Historical data list display	*7	●	●	●	●*5	
	Simple alarm display		●	●	●	●	
	System alarm display		●	●	—	—	
	Alarm display (user)	*7	●	●	●	●*5	
	Alarm display (system)	*7	●	●	—	—	
	Recipe display (record list)		●	●	●	●	
	Graph		●	●	●	●	
	Historical trend graph	*7	●	●	●	●*5	
	Graphical meter		●	●	●	●	
	Level, Panelmeter		●	●	●	●	
	Slider		●	●	●	●	
	Document display	○	●	●	—	—	
	Script parts		●	●	●	●	
	Functions performed on background GOT	Logging	*7	●	●	●	●*2
		Recipe	*7	●	●	●	●*5
		Device data transfer		●	●	●	●
Trigger action			●	●	●	●	
Time action		*7	●	●	●	●	
Hard copy		File output	*7	●	●	●	●*2
		Serial printer output		●	●	●	●*2
		Ethernet printer output		●	●	●	●*4
		PictBridge printer output	○	—	●*9	—	—
Project script, Screen script			●	●	●	●	
Object script			●	●	—	—	
Functions used with peripheral devices		Barcode function		●	●	●	●*2
		RFID function		●	●	●	●*2
		GOT Mobile function	○	●	●	—	—
		VNC server function	○	●	●	—	—
	Remote personal computer operation function (Ethernet)	○	●	●	—	—	
	Remote personal computer operation function (serial)	○	—	—	—	—	
	Video display function	○	—	—	—	—	
	RGB display function	○	—	—	—	—	
	Multimedia function	○	—	—	—	—	
	External I/O function	○	—	●*9	—	—	
	Operation panel function	○	—	●*9	—	—	
	Video output function	HDMI output	NEW ○	—	—	—	—
		RGB output function	○	—	—	—	—
	Report function	File output	*7	●	●	—	—
		Serial printer output	*7	●	●	●	●*2
		Ethernet printer output	*7	●	●	●	●*4
	PictBridge printer output	○	—	●*9	—	—	
	Sound output function	○*8	●	●*9	—	—	
	Server function, Client function		●	●	—	—	
	Mail send function		●	●	—	—	
	Network drive function		●	●	—	—	
	FTP server function	*7	●	●	●	●*4	
	File transfer function (FTP transfer)	○	●	●	—	—	
File transfer function (GOT internal transfer)	○	●	●	—	—		
MES interface function	○	●	●	—	—		
Wireless LAN function	○	●	●*9	—	—		
USB mouse, USB keyboard		●	●	●	—		

Category	Function name	Option devices	GT25		GT21		
			Wide model	Standard model	Wide model	Standard model	
GOT functions	Base screen		●	●	●	●	
	Overlap window		●	●	●	●	
	Superimpose window		●	●	●	●	
	Dialog window		●	●	●	●	
	Mobile screen		●	●	—	—	
	Key window		●	●	●	●	
	Language switching		●	●	●	●	
	System information		●	●	●	●	
	Operator authentication function	*7	●	●	●	●*5	
	Operation log	○	●	●	NEW	—	
	Startup logo		●	●	●	●	
	KANA KANJI conversion		●	●	—	—	
	FA transparent		●	●	●	●	
	SoftGOT-GOT link	○	●	●	—	—	
	Backup/Restoration	○	●	●	●	●*2	
	Multi-channel function			● 4 channels (No units can be mounted)	● 4 channels (Up to 3 units *9)	● 2 channels (No units can be mounted)	● 2 channels (No units can be mounted)
	Station No. switching		●	●	●	●	
	GOT network interaction		●	●	—	—	
	Screen gesture function		—	—	—	—	
	Object gesture function		—	—	—	—	
	Security key authentication function		●	●	—	—	
	IP filter function		●	●	●	●	
	File manager	*7	●	●	—	—	
	Vertical display *1			● (Rotate 90° to left)	● (Rotate 90° to left *10)	● (Rotate 90° to left)	● (Rotate 90° to right)
	Vision sensor monitor	NEW	●	●	—	—	
Maintenance functions	Device monitor	*7	●	●	●	●	
	Sequence program monitor (IQ-R ladder)	○	●	●	—	—	
	Sequence program monitor (Ladder)	○	●	●	—	—	
	Sequence program monitor (SFC)	○	●	●	—	—	
	Network monitor		●	●	—	—	
	CC-Link IE Field Network diagnostics		●	●	—	—	
	Intelligent module monitor		●	●	—	—	
	Drive recorder	*7	●	●	—	—	
	Servo amplifier graph	*7	●	●	—	—	
	Motion program editor			●*6 NEW	●*6	—	—
	Motion program I/O			●*6 NEW	●*6	—	—
	Servo amplifier monitor		●	●	—	—	
	R motion monitor		●	●	—	—	
	Q motion monitor		●	●	—	—	
	Motion SFC monitor	○	●	●	—	—	
	CNC monitor 2		—	●	—	—	
	CNC monitor		—	●*6	—	—	
	CNC data I/O	○	—	●*6	—	—	
	CNC machining program edit		—	●*6	—	—	
	Log viewer	*7	●	●	—	—	
	FX list editor		—	●	●	●*3	
FX ladder monitor		●	●	—	—		
iQSS utility	○	●	●	—	—		
System launcher		●	●	—	—		
System launcher (servo network)		●	●	—	—		
MELSEC-L troubleshooting		●	●	—	—		
GOT offline monitor	NEW *7	●	●	—	—		

*1 Remote personal computer operation function (Ethernet) cannot be used. The following screens are displayed horizontally: utility screen, monitor and data management screens that are displayed from the utility screen (sequence program monitor, etc.). For the details of other GOT operations when placed vertically, please refer to the relevant product manual or the Help.
 *2 Excluding GT2103-PMBLS.
 *3 GT2104-RTBD only.
 *4 GT2104-RTBD, GT2103-PMBD only.
 *5 On GT2103-PMBLS, only the functions that do not require SD memory card can be used.
 *6 Only the GOTs with SVGA or higher resolution are supported.
 *7 An SD memory card, a USB memory, or a battery is required depending on conditions of use.
 *8 The sound output unit is required for the standard models. GT25 wide models have a built-in sound output interface so that the unit is not required.
 *9 Excluding GT2505-VTBD, GT2506HS-VTBD, and GT2505HS-VTBD.
 *10 To install GT2505-VTBD vertically, rotate the unit 90° to the right.

Specifications - GT25 wide model

General specifications

Item	Specifications					
Operating ambient temperature *1	0 °C to 55 °C *5					
Storage ambient temperature	-20 °C to 60 °C					
Operating ambient humidity	10% RH to 90% RH, non-condensing					
Storage ambient humidity	10% RH to 90% RH, non-condensing					
Vibration resistance	Compliant with JIS B 3502 and IEC 61131-2	Under intermittent vibration	Frequency	Acceleration	Half amplitude	Sweep count 10 times in each X, Y, or Z direction
			5 to 8.4 Hz	—	3.5 mm	
		Under continuous vibration	8.4 to 150 Hz	9.8 m/s ²	—	—
			5 to 8.4 Hz	—	1.75 mm	—
Shock resistance	Compliant with JIS B 3502 and IEC 61131-2 (147 m/s ² (15G), 3 times in each X, Y, or Z direction)					
Operating atmosphere	No greasy fumes, corrosive gas, flammable gas, excessive conductive dust, and direct sunlight (as well as at storage)					
Operating altitude *2	2000 m or less					
Installation location	Inside control panel					
Overvoltage category *3	II or less					
Pollution degree *4	2 or less					
Cooling method	Self-cooling					
Grounding	Grounding with a ground resistance of 100 Ω or less by using a ground cable that has a cross-sectional area of 2 mm ² or more. If impossible, connect the ground cable to the control panel.					

- *1 Includes the temperature inside the enclosure of the control panel to which the GOT is installed.
- *2 Do not use or store the GOT under a pressure higher than the atmospheric pressure at altitude 0 m. Doing so may cause a malfunction. Air purging by applying pressure to the control panel may create clearance between the surface sheet and the touch panel. This may cause the touch panel to be not sensitive enough or the sheet to come off.
- *3 This indicates the section of the power supply to which the equipment is assumed to be connected between the public electrical power distribution network and the machinery within the premises. Category II applies to equipment that is supplied with power from fixed facilities. The withstand surge voltage for the equipment with the rated voltage up to 300 V is 2500 V.
- *4 This indicates the occurrence rate of conductive material in an environment where a device is used. Pollution degree 2 indicates an environment where only non-conductive pollution occurs normally and a temporary conductivity caused by condensation shall be expected depending on the conditions.
- *5 When a protective cover for oil is mounted on the GOT, the maximum operating ambient temperature must be 5 °C lower than the one described in the general specifications.

Power supply specifications

Item	Specifications		
	GT2512-WXTBD GT2512-WXTSD	GT2510-WXTBD GT2510-WXTSD	GT2507-WTBD GT2507-WTSD
Power supply voltage	24 V DC (+25%, -20%)		
Power supply frequency	—		
Power consumption	Under the maximum load	20 W or less	16 W or less
	Main unit	14 W	9 W
	Main unit (backlight OFF)	8 W	5 W
	Inrush current	59 A or less (2 ms, ambient temperature: 25 °C, under the maximum load)	
Permissible instantaneous power failure time	5 ms or less		
Noise immunity	Noise voltage: 500 Vp-p, noise width: 1 μs, measured by a noise simulator with noise frequency ranging from 25 Hz to 60 Hz		
Withstand voltage	350 V AC for 1 minute across power terminals and earth		
Insulation resistance	500 V DC across power terminals and earth, 10 MΩ or more by an insulation resistance tester		

For the status of conforming to various standards and laws (CE, ATEX, UL/cUL, Class I Division 2, EAC, KC, KCs, and maritime certifications [ABS/BV/DNV GL/LR/NK/RINA]), please refer to the Mitsubishi Electric Factory Automation Global website (www.MitsubishiElectric.com/fa).

Operate and store the GOT in environments without direct sunlight, high temperature, dust, humidity, and vibrations.

4

Specifications

Performance specifications

Item	Specifications					
	GT2512-WXTBD	GT2512-WXTSD	GT2510-WXTBD	GT2510-WXTSD	GT2507-WTBD	GT2507-WTSD
Display section *1,2	Display device					
	TFT color LCD					
	Screen size		12.1" widescreen		10.1" widescreen	
	Resolution		WXGA: 1280 × 800 dots		WVGA: 800 × 480 dots	
	Display size		261.12 (10.28) (W) × 163.2 (6.43) (H) mm (inch)		216.96 (8.54) (W) × 135.6 (5.34) (H) mm (inch)	
	Number of displayed characters		16-dot standard font: 80 characters × 50 lines (two-byte characters) 12-dot standard font: 106 characters × 66 lines (two-byte characters)		16-dot standard font: 50 characters × 30 lines (two-byte characters) 12-dot standard font: 66 characters × 40 lines (two-byte characters)	
	Display color		65536 colors			
	Brightness adjustment		32 levels			
	Backlight		LED (Not replaceable)			
	Backlight life *4		Approx. 50000 h (operating ambient temperature: 25 °C, display intensity: 50%)			
Touch panel *3	Type					
	Analog resistive film					
	Key size					
	Minimum 2 × 2 dots *8 (per key)					
Simultaneous press						
Not available *5 (Only 1 point can be touched.)						
Life						
1 million touches or more (operating force: 0.98 N or less)						
Panel color		Black	Silver *10	Black	Silver *10	Black
User memory	User memory capacity					
	Memory for storage (ROM): 32 MB Memory for operation (RAM): 128 MB					
Life (number of write times)		100000 times				
Built-in clock precision						
±90 seconds/month (ambient temperature: 25 °C)						
Battery						
GT11-50BAT lithium battery						
Life						
Approx. 5 years (ambient temperature: 25 °C)						
Built-in interface	RS-232					
	1 channel Transmission speed: 115200, 57600, 38400, 19200, 9600, 4800 bps Connector shape: D-sub 9-pin (male)					
	RS-422/485					
	1 channel Transmission speed: 115200, 57600, 38400, 19200, 9600, 4800 bps Connector shape: D-sub 9-pin (female)					
	Ethernet					
	2 channel Data transfer method: 100BASE-TX, 10BASE-T Connector shape: RJ45 (modular jack) AUTO MDI/MDI-X					
	USB (host)					
	1 channel (rear face)					
Built-in interface	USB (device)					
	USB version: USB 2.0 (High-Speed 480 Mbps) Connector shape: USB-A					
	1 channel (front face)					
	USB version: USB 2.0 (High-Speed 480 Mbps) Connector shape: USB Mini-B					
	SD memory card					
	1 channel, SDHC compliant (maximum 32 GB)					
Wireless LAN communication unit interface						
For installing a wireless LAN communication unit						
Sound output interface						
1 channel, WAV format (16 bits, 8.000 kHz/16.000 kHz, monoral) applicable plug: φ3.5 stereo mini-plug (3-prong)						
Buzzer output						
Single tone (tone and tone length adjustable)						
POWER LED						
2 colors (blue and orange)						
Protective structure *6						
Front: IP67F *7,9 Inside control panel: IP2X						
Safety standards, radio laws (as of March 2021)						
CE, UL, cUL, EAC, KC						
Maritime certifications (as of March 2021)						
ABS/BV/DNV GL/LR/NK/RINA						
External dimensions						
299 (11.77) (W) × 219 (8.62) (H) × 48 (1.89) (D) mm (inch)		252 (9.92) (W) × 194 (7.64) (H) × 48 (1.89) (D) mm (inch)		189 (7.44) (W) × 142 (5.59) (H) × 48 (1.89) (D) mm (inch)		
Panel cut dimensions						
290.5 (11.44) (W) × 210.5 (8.29) (H) mm (inch)		243.5 (9.59) (W) × 185.5 (7.30) (H) mm (inch)		180.5 (7.11) (W) × 133.5 (5.26) (H) mm (inch)		
Weight (excluding a fitting)						
1.7 (3.7) kg (lb)		1.2 (2.6) kg (lb)		0.75 (1.7) kg (lb)		
Compatible software package						
GT Works3 Version1.250L or later *11			GT Works3 Version1.175H or later *11			

- *1 As a characteristic of liquid crystal display panels, bright dots (always lit) and dark dots (never lit) may appear on the panel. Since liquid crystal display panels comprise a great number of display elements, the appearance of bright and dark dots cannot be reduced to zero. Individual differences in liquid crystal display panels may cause differences in color, uneven brightness and flickering. Note that these phenomena are characteristics of liquid crystal display panels and it does not mean the products are defective or damaged.
- *2 Flickering may occur due to vibration, shock, or the display colors.
- *3 When a stylus is used, the touch panel has a life of 100 thousand touches. The stylus must satisfy the following specifications.
• Material: polyacetal resin • Tip radius: 0.8 mm or more
- *4 To prevent the display section from burning in and lengthen the backlight life, enable the screen save function and turn off the backlight.
- *5 If you touch two points or more simultaneously on the touch panel, a touch switch near the touched points may operate unexpectedly. Do not touch two points or more simultaneously on the touch panel.
- *6 Note that the structure does not guarantee protection in all users' environments. The GOT may not be used in certain environments where it is subjected to splashing oil or chemicals for a long period of time or soaked in oil mist.
- *7 To conform to IP67F, close the USB environmental protection cover by pushing the USB mark firmly. (The GOT conforms to IP2X when the USB environmental protection cover is open.)
- *8 The minimum size of a key that can be arranged. To ensure safe use of the product, the following settings are recommended.
• Key size: 16 × 16 dots or larger • Distance between keys: 16 dots or more
- *9 The suffix 'F' of IP67F is a symbol that indicates protection rate against oil. It is described in the Appendix of Japanese Industrial Standard JIS C 0920.
- *10 The lower part of the panel including the USB environmental protection cover is black.
- *11 The supported version varies depending on the GOT model. To use new functions, GT Works3 Version1.250L or later is required.

Specifications - GT21 wide model

General specifications

Item	Specifications	
Operating ambient temperature *1	0 °C to 55 °C (horizontal installation) *6, 0 °C to 50 °C (vertical installation)	
Storage ambient temperature	-20 °C to 60 °C	
Operating ambient humidity	10% RH to 90% RH, non-condensing *2	
Storage ambient humidity	10% RH to 90% RH, non-condensing *2	
Vibration resistance	Compliant with JIS B 3502 and IEC 61131-2	
	Under intermittent vibration	Frequency: 5 to 8.4 Hz, Acceleration: —, Half amplitude: 3.5 mm, Sweep count: 10 times in each X, Y, or Z direction
	Under continuous vibration	5 to 8.4 Hz: Acceleration: 9.8 m/s ² , Half amplitude: —, Sweep count: —
		8.4 to 150 Hz: Acceleration: 4.9 m/s ² , Half amplitude: 1.75 mm, Sweep count: —
Shock resistance	Compliant with JIS B 3502 and IEC 61131-2 (147 m/s ² (15G), 3 times in each X, Y, or Z direction)	
Operating atmosphere	No greasy fumes, corrosive gas, flammable gas, excessive conductive dust, and direct sunlight (as well as at storage)	
Operating altitude *3	2000 m or less	
Installation location	Inside control panel	
Overvoltage category *4	II or less	
Pollution degree *5	2 or less	
Cooling method	Self-cooling	
Grounding	Grounding with a ground resistance of 100 Ω or less by using a ground cable that has a cross-sectional area of 2 mm ² or more. If impossible, connect the ground cable to the control panel.	

- *1 Includes the temperature inside the enclosure of the control panel to which the GOT is installed.
 *2 If the ambient temperature exceeds 40 °C, the absolute humidity must not exceed 90% RH at 40 °C.
 *3 Do not use or store the GOT under a pressure higher than the atmospheric pressure at altitude 0 m. Doing so may cause a malfunction. Air purging by applying pressure to the control panel may create clearance between the surface sheet and the touch panel. This may cause the touch panel to be not sensitive enough or the sheet to come off.
 *4 This indicates the section of the power supply to which the equipment is assumed to be connected between the public electrical power distribution network and the machinery within the premises. Category II applies to equipment that is supplied with power from fixed facilities. The withstand surge voltage for the equipment with the rated voltage up to 300 V is 2500 V.
 *5 This indicates the occurrence rate of conductive material in an environment where a device is used. Pollution degree 2 indicates an environment where only non-conductive pollution occurs normally and a temporary conductivity caused by condensation shall be expected depending on the conditions.
 *6 When a protective cover for oil is mounted on the GOT, the maximum operating ambient temperature must be 5 °C lower than the one described in the general specifications.

Power supply specifications

Item	Specifications	
	GT2107-WTBD	GT2107-WTSD
Power supply voltage	24 V DC (+10%, -15%)	
Power supply frequency	—	
Power consumption	Under the maximum load	11.3 W or less
	Main unit (backlight OFF)	7.0 W
Inrush current	35 A or less (3 ms, ambient temperature: 25 °C, under the maximum load)	
Permissible instantaneous power failure time	5 ms or less	
Noise immunity	Noise voltage: 1000 Vp-p, noise width: 1 μs, measured by a noise simulator with noise frequency ranging from 30 Hz to 100 Hz	
Withstand voltage	500 V AC for 1 minute across power terminals and earth	
Insulation resistance	500 V DC across power terminals and earth, 10 MΩ or more by an insulation resistance tester	

For the status of conforming to various standards and laws (CE, ATEX, UL/cUL, Class I Division 2, EAC, KC, KCs, and maritime certifications (ABS/BV/DNV GL/LR/NK/RINA)), please refer to the Mitsubishi Electric Factory Automation Global website (www.MitsubishiElectric.com/fa).

Operate and store the GOT in environments without direct sunlight, high temperature, dust, humidity, and vibrations.

Performance specifications

Item	Specifications		
	GT2107-WTBD	GT2107-WTSD	
Display section *1-2	Display device	TFT color LCD	
	Screen size	7" widescreen	
	Resolution	WVGA: 800 × 480 dots	
	Display size	152.40 (6.00) (W) × 91.44 (3.60) (H) mm (inch)	
	Number of displayed characters	16-dot standard font: 50 characters × 30 lines (two-byte characters) 12-dot standard font: 66 characters × 40 lines (two-byte characters)	
	Display color	65536 colors	
	Brightness adjustment	32 levels	
	Backlight	LED (Not replaceable)	
Backlight life *4	Approx. 50000 h (operating ambient temperature: 25 °C, display intensity: 50%)		
Touch panel *3	Type	Analog resistive film	
	Key size	Minimum 2 × 2 dots *8 (per key)	
	Simultaneous press	Not available *5 (Only 1 point can be touched.)	
	Life	1 million touches or more (operating force: 0.98 N or less)	
Panel color	Black	Silver *10	
User memory	User memory capacity	Memory for storage (ROM): 15 MB	
	Life (number of write times)	100000 times	
Built-in clock precision	±45 seconds/month (ambient temperature: 25 °C)		
Battery	GT11-50BAT lithium battery		
	Life	Approx. 5 years (ambient temperature: 25 °C)	
Built-in interface	RS-232	1 channel Transmission speed: 115200, 57600, 38400, 19200, 9600, 4800 bps Connector shape: D-sub 9-pin (male)	
	RS-422/485	1 channel Transmission speed: 115200, 57600, 38400, 19200, 9600, 4800 bps Connector shape: D-sub 9-pin (female) Terminating resistor: OPEN/110 Ω/330 Ω (switched with the terminating resistor setting switch)	
	Ethernet	1 channel Data transfer method: 100BASE-TX, 10BASE-T Connector shape: RJ45 (modular jack) AUTO MDI/MDI-X	
	USB (host)	1 channel (rear face) USB version: USB 1.1 (Full-Speed 12 Mbps) Connector shape: USB-A	
	USB (device)	1 channel (front face)	
		USB version: USB 1.1 (Full-Speed 12 Mbps) Connector shape: USB Mini-B	
	SD memory card	1 channel, SDHC compliant (maximum 32 GB)	
Wireless LAN communication unit interface	—		
Sound output interface	—		
Buzzer output	Single tone (tone length adjustable)		
POWER LED	—		
Protective structure *6	Front: IP67F *7-9 Inside control panel: IP2X		
Safety standards, radio laws (as of March 2021)	CE, UL, cUL, EAC, KC		
Maritime certifications (as of March 2021)	—		
External dimensions	189 (7.44) (W) × 142 (5.59) (H) × 48 (1.89) (D) mm (inch)		
Panel cut dimensions	180.5 (7.11) (W) × 133.5 (5.26) (H) mm (inch)		
Weight (excluding a fitting)	0.7 (1.54) kg (lb)		
Compatible software package	GT Works3 Version 1.170C or later *11		

- *1 As a characteristic of liquid crystal display panels, bright dots (always lit) and dark dots (never lit) may appear on the panel. Since liquid crystal display panels comprise a great number of display elements, the appearance of bright and dark dots cannot be reduced to zero. Individual differences in liquid crystal display panels may cause differences in color, uneven brightness and flickering. Note that these phenomena are characteristics of liquid crystal display panels and it does not mean the products are defective or damaged.
 *2 Flickering may occur due to vibration, shock, or the display colors.
 *3 When a stylus is used, the touch panel has a life of 100 thousand touches. The stylus must satisfy the following specifications.
 • Material: polyacetal resin • Tip radius: 0.8 mm or more
 *4 To prevent the display section from burning in and lengthen the backlight life, enable the screen save function and turn off the backlight.
 *5 If you touch two points or more simultaneously on the touch panel, a touch switch near the touched points may operate unexpectedly. Do not touch two points or more simultaneously on the touch panel.
 *6 Note that the structure does not guarantee protection in all users' environments. The GOT may not be used in certain environments where it is subjected to splashing oil or chemicals for a long period of time or soaked in oil mist.
 *7 To conform to IP67F, close the USB environmental protection cover by pushing the USB mark firmly. (The GOT conforms to IP2X when the USB environmental protection cover is open.)
 *8 The minimum size of a key that can be arranged. To ensure safe use of the product, the following settings are recommended.
 • Key size: 16 × 16 dots or larger • Distance between keys: 16 dots or more
 *9 The suffix "F" of IP67F is a symbol that indicates protection rate against oil. It is described in the Appendix of Japanese Industrial Standard JIS C 0920.
 *10 The lower part of the panel including the USB environmental protection cover is black.
 *11 The supported version varies depending on the GOT model. To use new functions, GT Works3 Version 1.250L or later is required.

External dimensions

GT25 wide model

GT2512-WXT□D **NEW**

Unit: mm (inch)

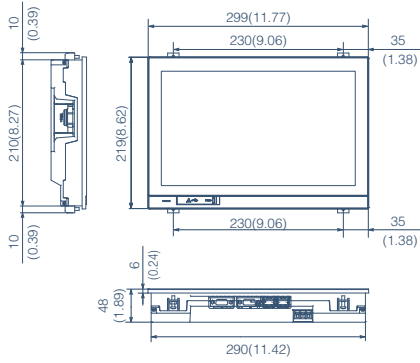

GT2510-WXT□D

Unit: mm (inch)

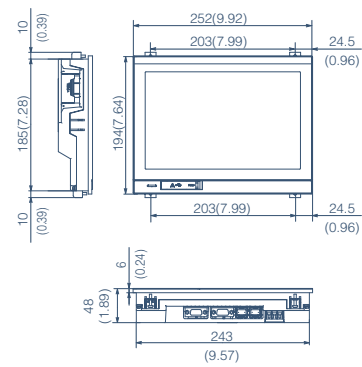

GT2507-WT□D

Unit: mm (inch)

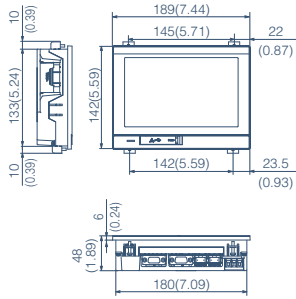

GT21 wide model

GT2107-WT□D

Unit: mm (inch)

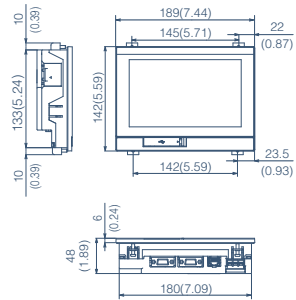

Panel cut dimensions

Unit: mm (inch)

Screen size	Model	A	B
12.1" widescreen	GT2512-WXT□D	290.5 (11.44)	210.5 (8.29)
10.1" widescreen	GT2510-WXT□D	243.5 (9.59)	185.5 (7.30)
7" widescreen	GT2507-WT□D GT2107-WT□D	180.5 (7.11)	133.5 (5.26)

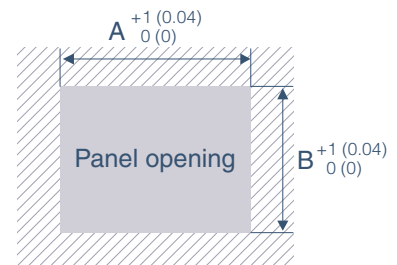

* Panel thickness: 1.6 mm to 4 mm
(0.06 inch to 0.16 inch)

Product list

GOTs

Classification		Model	Screen size	Display section Display color	Panel color	Power
Wide model	GT25	GT2512-WXTBD NEW	12.1" WXGA	TFT color 65536 colors	Black	24 V DC
		GT2512-WXTSD NEW			Silver *1	
		GT2510-WXTBD	10.1" WXGA		Black	
		GT2510-WXTSD			Silver *1	
	GT21	GT2507-WTBD	7" WVGA		Black	
		GT2507-WTSD			Silver *1	
		GT2107-WTBD	7" WVGA	TFT color 65536 colors	Black	24 V DC
		GT2107-WTSD		Silver *1		

*1 The lower part of the panel including the USB environmental protection cover is black.

Communication units

Product name	Model	Specifications	Supported model	
			GT25 Wide	GT21 Wide
Wireless LAN communication unit *1	GT25-WLAN	IEEE802.11b/g/n compliant, built-in antenna, wireless LAN access point (base station) *2, station (client), connection to personal computer, tablet, smartphone Compliance with*3: Japan Radio Law, FCC standards, RE Directive*4 (R&TE Directive), SRRC, KC	●	—

*1 Data transfer in wireless LAN communication may not be as stable as that in cable communication. A packet loss may occur depending on the surrounding environment and the installation location. Be sure to perform a confirmation of operation before using this product.

*2 When [Operation Mode] is set to [Access Point] in [Wireless LAN Setting] of GT Designer3, up to five stations are connectable.

*3 The product with hardware version A complies with Japan Radio Law and can be used only in Japan. The product with hardware version B or later complies with FCC standards and RE Directive and can be used in Japan, the United States, the EU member states, Switzerland, Norway, Iceland, and Liechtenstein. The product with hardware version D or later complies with SRRC and KC and can be used in Japan, the United States, the EU member states, Switzerland, Norway, Iceland, Liechtenstein, China (excluding Hong Kong, Macau, Taiwan), and South Korea. For the latest information about countries where the unit can be used, please refer to the Mitsubishi Electric Factory Automation Global website (www.MitsubishiElectric.com/fa).

*4 The wireless LAN communication unit has conformed to the RE directive since March 31, 2017.

Options

Product name	Model	Specifications	Supported model	
			GT25 Wide	GT21 Wide
Protective sheet	GT25-12WPSGC NEW	For 12.1" wide models	●	—
	GT25-10WPSGC	For 10.1" wide models	●	—
	GT21-07WPSGC	For 7" wide models	●	●
	GT25-12WPSCC NEW	For 12.1" wide models	●	—
	GT25-10WPSCC	For 10.1" wide models	●	—
	GT21-07WPSCC	For 7" wide models	●	●
Stand	GT25-10WSTAND	For 10.1" wide models	●	—
	GT21-07WSTAND	For 7" wide models	●	●
USB environmental protection cover	GT21-WUCOV	For 12.1" wide/10.1" wide/7" wide models	●	●
Protective cover for oil *3	GT21-12WPCO NEW	For 12.1" wide models	●	—
	GT21-10WPCO	For 10.1" wide models	●	—
	GT21-07WPCO	For 7" wide models	●	●
SD memory card	NZ1MEM-2GBSD	SD memory card for GOT, 2 GB	●	●
	NZ1MEM-4GBSD	SDHC memory card for GOT, 4 GB	●	●
	NZ1MEM-8GBSD	SDHC memory card for GOT, 8 GB	●	●
	NZ1MEM-16GBSD	SDHC memory card for GOT, 16 GB	●	●
Battery	GT11-50BAT	Battery for backup of SRAM data, clock data, and system status log data *2.	● (For replacement)	● (For replacement)
Panel-mounted USB port extension	GT14-C10EXUSB-4S	Cable length: 1m, for routing the USB port (host) of the GOT rear face to the front side of the control panel	●	●
USB cable (data transfer cable)	GT09-C30USB-5P	Cable length: 3m, for connecting a personal computer (screen design software) and GOT	●	●

*1 The protective sheet is shaped not to cover the USB environmental protection cover.

*2 GT21 does not support the system status log data backup function.

*3 Check if the protective cover for oil can be used in the actual environment before use. When using the cover, the front USB interface cannot be used.

Software

Product name	Model	Description		Supported model		
				GT25 Wide	GT21 Wide	
HMI/GOT Screen Design Software MELSOFT GT Works3	SW1DND-GTWK3-E	English Version	Standard license product	DVD-ROM	●	●
	SW1DND-GTWK3-EA		Volume license product *1*5			
	SW1DND-GTWK3-EAZ		Additional license product *1*2			
GT Works Text to Speech License *4	SW1DND-GTVO-M	Standard license product		●	—	
VNC Server Function License *3	GT25-VNCSKEY-1	1 license		●	●	
	GT25-VNCSKEY-5	5 licenses		●	●	
	GT25-VNCSKEY-10	10 licenses		●	●	
	GT25-VNCSKEY-20	20 licenses		●	●	
GOT Mobile Function License *3	GT25-WEBSKEY-1	1 license		●	—	
	GT25-WEBSKEY-5	5 licenses		●	—	
	GT25-WEBSKEY-10	10 licenses		●	—	
	GT25-WEBSKEY-20	20 licenses		●	—	

*1 The desired number of licenses (2 or more) can be purchased. For details, please contact your local sales office.

*2 This product does not include the DVD-ROM. Only the license certificate with the product ID No. is issued.

*3 Each GOT requires one license.

*4 To edit sound files, each personal computer requires one license.

*5 Volume license product is not sold separately and should be purchased with the standard license product.

Global FA Centers



China Mainland

Shanghai FA Center

Mitsubishi Electric Automation (China) Ltd.
Mitsubishi Electric Automation Center, No.1386
Hongqiao Road, Shanghai, China
Tel: +86-21-2322-3030 / Fax: +86-21-2322-3000(9611#)

Beijing FA Center

Mitsubishi Electric Automation (China) Ltd.
Beijing Branch
5/F, ONE INDIGO, 20 Jiuxianqiao Road Chaoyang
District, Beijing, China
Tel: +86-10-6518-8830 / Fax: +86-10-6518-2938

Tianjin FA Center

Mitsubishi Electric Automation (China) Ltd.
Tianjin Branch
Room 3203 City Tower, No.35, Youyi Road, Hexi
District, Tianjin, China
Tel: +86-22-2813-1015 / Fax: +86-22-2813-1017

Guangzhou FA Center

Mitsubishi Electric Automation (China) Ltd.
Guangzhou Branch
Room 1609, North Tower, The Hub Center, No.1068,
Xingang East Road, Haizhu District, Guangzhou, China
Tel: +86-20-8923-6730 / Fax: +86-20-8923-6715

Taiwan

Taipei FA Center

SETSUYO ENTERPRISE CO., LTD.
3F, No.105, Wugong 3rd Road, Wugu District,
New Taipei City 24889, Taiwan
Tel: +886-2-2299-9917 / Fax: +886-2-2299-9963

Korea

Korea FA Center

Mitsubishi Electric Automation Korea Co., Ltd.
8F, Gangseo Hangang Xi-tower A, 401,
Yangcheon-ro, Gangseo-Gu, Seoul 07528, Korea
Tel: +82-2-3660-9632 / Fax: +82-2-3664-0475

ASEAN

ASEAN FA Center

Mitsubishi Electric Asia Pte. Ltd.
307 Alexandra Road, Mitsubishi Electric Building,
Singapore 159943
Tel: +65-6470-2475 / Fax: +65-6476-7439

Indonesia

Indonesia FA Center

PT. Mitsubishi Electric Indonesia Cikarang Office
Jl. Kenari Raya Blok G2-07A Delta Silicon 5,
Lippo Cikarang - Bekasi 17550, Indonesia
Tel: +62-21-2961-7797 / Fax: +62-21-2961-7794

Vietnam

Hanoi FA Center

Mitsubishi Electric Vietnam Co., LTD.
Hanoi Branch
6th Floor, Detch Tower, 8 Ton That Thuyet Street,
My Dinh 2 Ward, Nam Tu Liem District, Hanoi,
Vietnam
Tel: +84-24-3937-8075 / Fax: +84-24-3937-8076

Ho Chi Minh FA Center

Mitsubishi Electric Vietnam Co., LTD.
Ho Chi Minh Head Office
11th & 12th Floor, Viettel Tower B, 285 Cach Mang
Thang 8 Street, Ward 12, District 10, Ho Chi Minh City,
Vietnam
Tel: +84-28-3910-5945 / Fax: +84-28-3910-5947

Thailand

Thailand FA Center

Mitsubishi Electric Factory Automation
(Thailand) Co., Ltd.
101, True Digital Park Office, 5th Floor, Sukhumvit Road,
Bangchak, Phra Khanong, Bangkok 10260, Thailand
Tel: +66-2092-8600 / Fax: +66-2043-1231-33

Philippines

Philippines FA Center

MELCO Factory Automation Philippines Inc.
128, Lopez-Rizal St. Brgy. Highway Hills,
Mandaluyong City, MM, Philippines
Tel: +63-(0)2-8256-8042 / Fax: -

India

India Pune FA Center

Mitsubishi Electric India Pvt. Ltd.
Pune Branch
Emerald House, EL-3, J Block, M.I.D.C., Bhosari,
Pune - 411026, Maharashtra, India
Tel: +91-20-2710-2000 / Fax: +91-20-2710-2100

India Gurgaon FA Center

Mitsubishi Electric India Pvt. Ltd.
Gurgaon Second office MEI-GGN (UDY)
Plot 517, Ground floor, Udyog Vihar Phase 3,
Gurugram 122008, Haryana, India
Tel: +91-124-463-0300 / Fax: +91-124-463-0399

India Bangalore FA Center

Mitsubishi Electric India Pvt. Ltd.
Bangalore Branch
Prestige Emerald, 6th Floor, Municipal No.2,
Madras Bank Road, Bangalore - 560001, Karnataka, India
Tel: +91-80-4020-1600 / Fax: +91-80-4020-1699

India Chennai FA Center

Mitsubishi Electric India Pvt. Ltd.
Chennai Branch
Citilights Corporate Centre No.1, Vivekananda
Road, Srinivasa Nagar, Chetpet, Chennai - 600031,
Tamil Nadu, India
Tel: +91-44-4554-8772 / Fax: +91-44-4554-8773

India Ahmedabad FA Center

Mitsubishi Electric India Pvt. Ltd.
Ahmedabad Branch
B/4, 3rd Floor, SAFAL Profitaire, Corporate Road,
Pralhadnagar, Satellite, Ahmedabad - 380015,
Gujarat, India
Tel: +91-79-6512-0063 / Fax: -

India Coimbatore FA Center

Mitsubishi Electric India Pvt. Ltd.
Coimbatore Branch
BMH Srinivas, 2nd Floor, Door No.1604, Trichy Road,
Near ICICI Bank, Coimbatore - 641018, Tamil Nadu, India
Tel: +91-422-438-5606 / Fax: -

Americas

North America FA Center

Mitsubishi Electric Automation, Inc.
500 Corporate Woods Parkway, Vernon Hills, IL 60061, U.S.A.
Tel: +1-847-478-2100 / Fax: +1-847-478-2253

Mexico

Mexico FA Center

Mitsubishi Electric Automation, Inc.
Queretaro Office
Parque Tecnológico Innovacion Queretaro Lateral Carretera
Estatel 431, Km 2+200, Lote 91 Modulos 1 y 2 Hacienda La
Machorra, CP 76246, El Marques, Queretaro, Mexico
Tel: +52-442-153-6014 / Fax: -

Mexico City FA Center

Mitsubishi Electric Automation, Inc.
Mexico Branch
Mariano Escobedo #69, Col. Zona Industrial,
Tlalnepanitla Edo. Mexico, C.P.54030
Tel: +52-55-3067-7511 / Fax: -

Mexico Monterrey FA Center

Mitsubishi Electric Automation, Inc.
Monterrey Office
Plaza Mirage, Av. Gonzalitos 460 Sur, Local 28, Col. San
Jeronimo, Monterrey, Nuevo Leon, C.P. 64640, Mexico
Tel: +52-55-3067-7521 / Fax: -

Brazil

Brazil FA Center

Mitsubishi Electric do Brasil Comercio e
Servicos Ltda.
Avenida Adelino Cardana, 293, 21 andar, Bethaville,
Barueri SP, Brasil
Tel: +55-11-4689-3000 / Fax: +55-11-4689-3016

Europe

Europe FA Center

Mitsubishi Electric Europe B.V. Polish Branch
ul. Krakowska 48, 32-083 Balice, Poland
Tel: +48-12-347-65-00 / Fax: -

Germany FA Center

Mitsubishi Electric Europe B.V. German Branch
Mitsubishi-Electric-Platz 1, 40882 Ratingen, Germany
Tel: +49-2102-486-0 / Fax: +49-2102-486-1120

UK FA Center

Mitsubishi Electric Europe B.V. UK Branch
Travellers Lane, Hatfield, Hertfordshire, AL10 8XB, U.K.
Tel: +44-1707-27-8780 / Fax: +44-1707-27-8695

Italy FA Center

Mitsubishi Electric Europe B.V. Italian Branch
Centro Direzionale Colleoni - Palazzo Sirio, Viale
Colleoni 7, 20864 Agrate Brianza (MB), Italy
Tel: +39-039-60531 / Fax: +39-039-6053-312

Czech Republic FA Center

Mitsubishi Electric Europe B.V. Czech Branch
Pekarska 621/7, 155 00 Praha 5, Czech Republic
Tel: +420-255-719-200 / Fax: -

Russia FA Center

Mitsubishi Electric (Russia) LLC
St. Petersburg Branch
Piskarevsky pr. 2, bld 2, lit "Sch", BC "Benua",
office 720; 195027, St. Petersburg, Russia
Tel: +7-812-633-3497 / Fax: +7-812-633-3499

Turkey FA Center

Mitsubishi Electric Turkey A.S. Umraniye Branch
Serifali Mah. Kale Sok. No:41 34775
Umraniye - Istanbul, Turkey
Tel: +90-216-969-2500 / Fax: +90-216-526-3995

Trademarks and registered trademarks

MELSOFT, GOT, CC-Link, CC-Link IE are either trademarks or registered trademarks of Mitsubishi Electric Corporation in Japan and other countries. ETHERNET is a registered trademark of Xerox Corp.
SD and SDHC Logos are registered trademarks or trademarks of SD-3C, LLC.
VNC is a registered trademark of RealVNC Ltd. in the United States and other countries.
PictBridge is a registered trademark of Canon Inc.
Android and Google Chrome are trademarks or registered trademarks of Google Inc.
Safari and iPhone are trademarks of Apple Inc., registered in the U.S. and other countries. The iPhone trademark is used under license from AIPHONE CO., LTD.
Other product and company names are either trademarks or registered trademarks of their respective owners.

The actual color may differ slightly from the pictures in this catalog.
The actual display may differ from what are shown on GOT screen images.

Precautions before use

This publication explains the typical features and functions of the products herein and does not provide restrictions or other information related to usage and module combinations. Before using the products, always read the product user manuals. Mitsubishi Electric will not be held liable for damage caused by factors found not to be the cause of Mitsubishi Electric; opportunity loss or lost profits caused by faults in Mitsubishi Electric products; damage, secondary damage, or accident compensation, whether foreseeable or not, caused by special factors; damage to products other than Mitsubishi Electric products; or any other duties.

 For safe use

- To use the products given in this publication properly, always read the relevant manuals before beginning operation.
- The products have been manufactured as general-purpose parts for general industries, and are not designed or manufactured to be incorporated in a device or system used in purposes related to human life.
- Before using the products for special purposes such as nuclear power, electric power, aerospace, medicine or passenger-carrying vehicles, consult with Mitsubishi Electric.
- The products have been manufactured under strict quality control. However, when installing the products where major accidents or losses could occur if the products fail, install appropriate backup or fail-safe functions in the system.

YOUR SOLUTION PARTNER

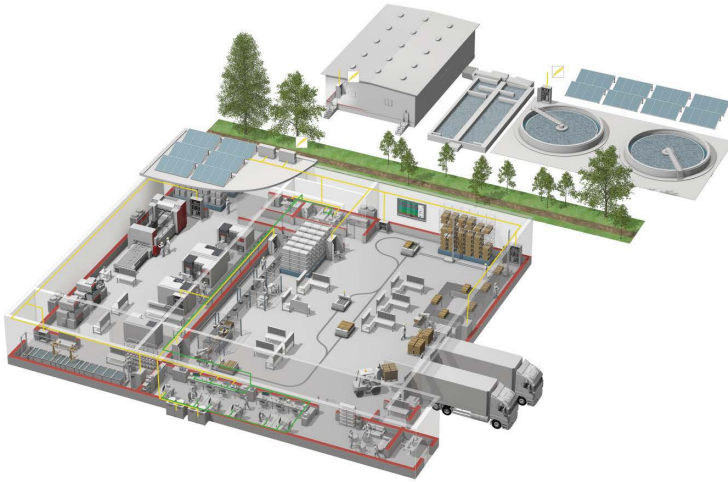

Mitsubishi Electric offers a wide range of automation equipment from PLCs and HMIs to CNC and EDM machines.

A NAME TO TRUST

Since its beginnings in 1870, some 45 companies use the Mitsubishi name, covering a spectrum of finance, commerce and industry.

The Mitsubishi brand name is recognized around the world as a symbol of premium quality.

Mitsubishi Electric Corporation, established in 1921, is active in space development, transportation, semi-conductors, energy systems, communications and information processing, audio visual equipment and home electronics, building and energy management and automation systems, and has 183 factories, laboratories and offices worldwide in over 140 countries.

This is why you can rely on Mitsubishi Electric automation solution - because we know first hand about the need for reliable, efficient, easy-to-use automation and control in our own factories.

As one of the world's leading companies with a global turnover of over 4 trillion Yen (over \$40 billion), employing over 146,000 people, Mitsubishi Electric has the resource and the commitment to deliver the ultimate in service and support as well as the best products.



Low voltage: MCCB, MCB, ACB



Medium voltage: VCB, VCC



Power monitoring, energy management



Compact and Modular Controllers



Inverters, Servos and Motors



Visualization: HMIs



Numerical Control (NC)



Industrial / Collaborative Robots



Processing machines: EDM, Lasers, IDS



Transformers, Air conditioning, Photovoltaic systems

* Not all products are available in all countries.

Global Partner. Local Friend.

GOT2000 *Wide* Graphic Operation Terminal

The release date varies depending on the product and your region. For details, please contact your local sales office.

mitsubishi electric corporation

HEAD OFFICE: TOKYO BLDG., 2-7-3, MARUNOUCHI, CHIYODA-KU, TOKYO 100-8310, JAPAN
NAGOYA WORKS: 1-14, YADA-MINAMI 5, HIGASHI-KU, NAGOYA, JAPAN

Country/Region Sales office
USA+1-847-478-2100
Mexico+52-55-3067-7512
Brazil+55-11-4689-3000
China+86-21-2322-3030
Taiwan+886-2-2299-2499
Korea+82-2-3660-9569

Singapore+65-6473-2308
Malaysia+60-3-7958-3544
Indonesia+62-21-3192-6461
Vietnam+84-28-3910-5945
Thailand+66-2092-8600
Philippines+63-(0)2-8256-8042

India+91-20-2710-2000
Australia+61-2-9684-7777
Germany+49-2102-486-0
UK+44-1707-28-8780
Italy+39-039-60531
Spain+34-935-65-3131

France+33-1-55-68-55-68
Czech Republic...+420-255-719-200
Turkey+90-216-969-2500
Poland+48-12-347-65-00
Russia+7-812-449-51-34
South Africa+27-11-658-8100