

INVERTER

FR-E800

Addition of single-phase 100 V class

E800



GLOBAL IMPACT OF MITSUBISHI ELECTRIC



Through Mitsubishi Electric's vision, "Changes for the Better" are possible for a brighter future.

Changes for the Better

"Changes for the Better" represents the Mitsubishi Electric Group's attitude to "always strive to achieve something better", as we continue to change and grow. Each one of us shares a strong will and passion to continuously aim for change, reinforcing our commitment to creating "an even better tomorrow".

Mitsubishi Electric is involved in many areas including the following:

Energy and Electric Systems

A wide range of power and electrical products from generators to large-scale displays.

Electronic Devices

A wide portfolio of cutting-edge semiconductor devices for systems and products.

Home Appliance

Dependable consumer products like air conditioners and home entertainment systems.

Information and Communication Systems

Commercial and consumer-centric equipment, products and systems.

Industrial Automation Systems

Maximizing productivity and efficiency with cutting-edge automation technology.



The Mitsubishi Electric Group is actively solving social issues, such as decarbonization and labor shortages, by providing production sites with energy-saving equipment and solutions that utilize automation systems, thereby helping towards a sustainable society.

Features	4	
Operation Panel, Operation Steps	44	1
Parameter List	49	2
Protective Functions	72	3
Standard Specifications	77	4
Outline Dimensions	83	5
Terminal Connection Diagram, Terminal Specifications	85	6
Example Connections	92	7
Options	94	8
Low-Voltage Switchgear/Cables	118	9
Precaution on Selection and Operation	124	10
Compatible Motors	131	11
Compatibility	144	12
Warranty	151	13
Support	152	14

Design future manufacturing

FR-E800—World's smallest class inverter with high functionality

Ever since the Industrial Revolution, manufacturing technologies have evolved over the years.

And now, this is the time for new revolution.

A new era has started. Inverters are connected to the world.

We design future manufacturing and what's ahead.

E800





E800-E Ethernet model

E800-SCE Safety communication model



E800 Standard model



Product video



IoT



Smart factory made possible through industrial IoT

AI

Artificial intelligence (AI) supports users in various ways

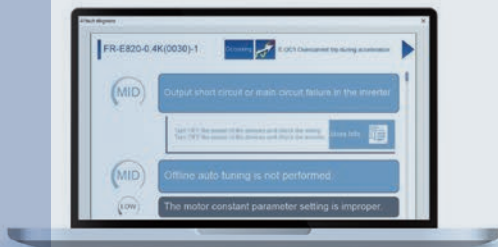

E800

Real-time connection with the host IT system enables centralized or remote monitoring of operation, which further streamlines the production.

1 Improving productivity by supporting CC-Link IE TSN as standard

Real-time production data collection is enabled by high-speed, stable communication, which contributes to improvement of productivity.

CC-Link IE TSN

>> P13

2 Expanding a range of applications with multi-protocols

Multi-protocol support enables switching between various types of communication networks.

Protocols of major global industrial Ethernet networks are supported by the inverter without using a plug-in option.

**EtherNet/IP
PROFINET
EtherCAT, etc.**

>> P13

3 Enabling flexible connection with two Ethernet ports provided as standard

Connection in line topology without using a switching hub is enabled, which widens the choice of connection methods.

**Two Ethernet
ports**

>> P14

AI technology and smartphone connectivity support initial startup or troubleshooting. Extensive maintenance functions will contribute to improvement in maintainability.

1 Reducing downtime using the AI function

The AI fault diagnosis function is used to identify the cause of a fault, enabling the fastest troubleshooting procedure.

**AI fault
diagnosis**

>> P27

2 Enhancing predictive maintenance

Integrating the world's first*1 "Corrosive-Attack-Level Alert System (CALAS™)"**2 makes it possible to identify signs of inverter damage caused by corrosive gas. The environmental impact diagnosis function for the control circuit board enables visualization of the environment where the inverter is installed, enhancing maintainability and preventing faults (for coated models (-60/-06) only).

**Environmental
impact diagnosis
function**

>> P25

*1: According to our investigation as of September 10, 2019.

**2: Patent applied for.

Alert system for the risk of corrosive damage (degree of corrosion) of electrical equipment

3 Further facilitating operation with your smartphone

Using smartphones or tablets, users can scan the QR code on the product to access the setup information, or can access inverters via wireless network with a mobile app. This will contribute to reduction in startup time and improvement in maintainability.

**Engineering
software**

>> P30

Safety

Advanced harmony
between humans and
FA devices



Performance

Various solutions
achieved by the outstanding
drive performance

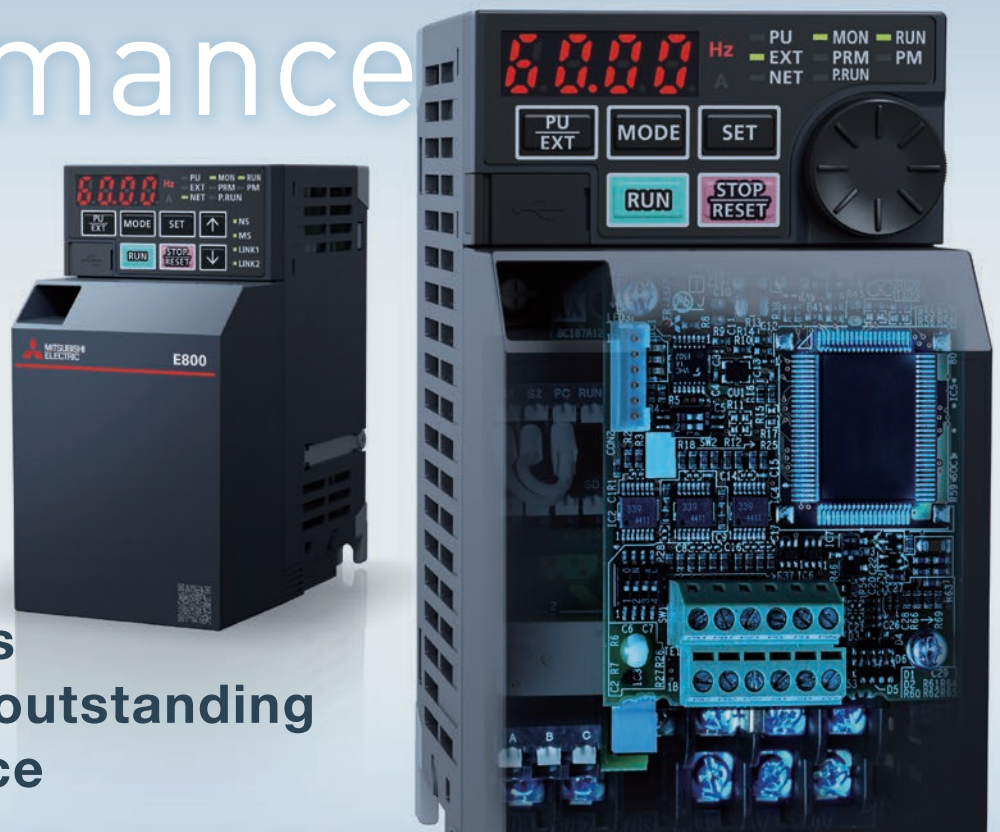

Available when the plug-in option is connected.

Functional safety functions and wireless inverter connection enable stable and safe operation of the system.

1 Reducing the costs for safety

The inverter is compliant with safety integrity level (SIL) 2 or 3 of the IEC 61508 standard for functional safety.

Functional safety >> P21

Safety monitoring functions conforming to IEC 61800-5-2, such as the safe torque off (STO) and safely-limited speed (SLS) functions, ensure safe operation for users.

2 Configuring simple safety systems

The inverter supporting safety communication eliminate the needs of preparing separate safety communication devices or complex wiring for both control and network cables.

Safety communication >> P15

3 Ensuring operators' safety by wireless interfaces

Adjustments of inverter parameters and inverter monitoring can be performed wirelessly away from the system, ensuring operators' safety.

Ethernet connection*1 >> P20

*1: Several conditions must be met to use this function.

Various control methods are supported to expand applications in many systems. Reducing energy consumption contributes to carbon neutrality.

1 Supporting various control methods

Various control methods such as Vector control (with encoder), Real sensorless vector control (without encoder), and positioning without using sensors are supported. Premium efficiency motors and PM motors are supported, enabling applications in various solutions.

Control method >> P19

2 Reducing environmental loads

Driving high-efficiency motors and using regenerative power contributes to reduction of energy consumption in production lines.

Energy saving >> P22

3 Expanding applications with the enhanced product line

The product line is enhanced as compared to the preceding FR-E700 inverters.

- 18.5K and 22K models supported
- 575 V class supported
- Surrounding air temperature of -20°C to 60°C*1
- Compliance with IEC 60721-3-3:1994 3C2*2 for corrosive gas concentration
- IP67 models (FR-E846)

Expanded capacity range / improved environmental resistance >> P16

*1: Derating required for 50°C or higher.

*2: Coated model (-60/-06) only

Useful functions for each of the design, operation, and maintenance processes of systems

FR-E800 inverters have various functions to attract more customers by offering safe and reliable operation for a long time.

This is the time to start innovation in the fields of manufacturing.

Design

1



Toward smart factory

Supporting various networks enable flexible system design.

P12-15

2



Wide range of applications

The expanded range of capacities and dimensions supports various applications.

P16-17

3



Higher added values

The outstanding drive performance and various functions create higher added values.

P18-19

Operation

4



Improved safety

Humans and FA devices can work together by enhancing functional safety.

P20-21

5



Energy saving

Use of induction motors or IPM motors contributes to energy saving.

P22-23

Maintenance

6



Improved maintainability

Functions for residual life diagnosis, predictive maintenance, and preventive maintenance support stable system operation.

P24-25

7



Downtime reduction

When a fault occurs, AI analysis and other diagnosis functions solve the problem quickly.

P26-29

Engineering tools

8



Engineering software for further ease of operation

The work efficiency can be improved for each of the design, operation, and maintenance processes.

P30-33

1



Design

Toward smart factory

Supporting various networks enable flexible system design.



Smart factory

Office



Real-time remote monitoring of operation of each factory enables interconnection between factories. In case of troubles, quick detection enables fast recovery.

Internet



Factory A



Production volume is adjusted based on the warehouse condition.

Warehouse

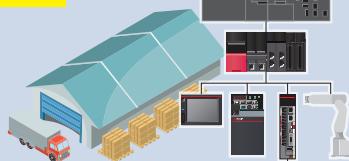

Products are stored in a warehouse. Stock control information is shared with the office and the factories.

Factory B

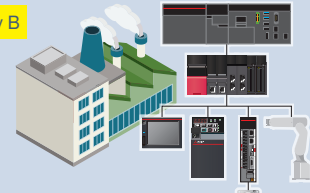

Production volume of Factory B is adjusted efficiently based on the production condition of Factory A.

1 Less workload required for system construction

▶ CC-Link IE TSN supported as standard

- Deterministic performance of cyclic communication is maintained even when mixed with slower information data (non real-time). This enables TCP/IP communication devices to be used without affecting overall control.
- Network device profiles are available to facilitate network construction.

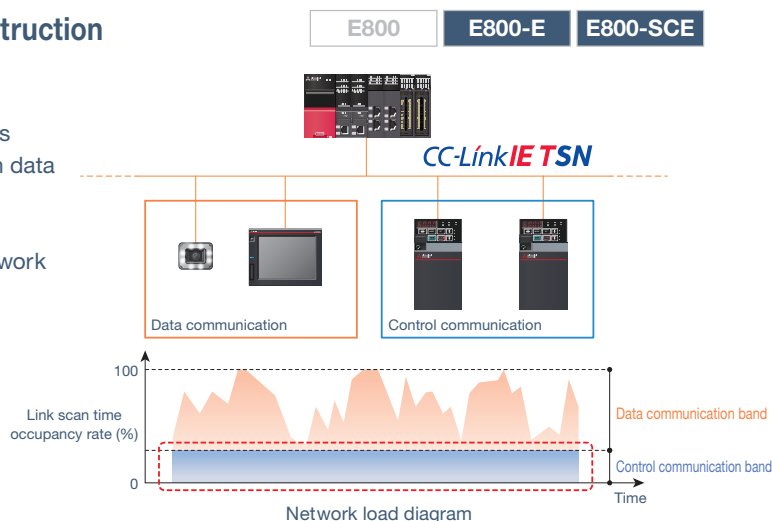

- Non-FA devices that support SLMP and TCP/IP communication can also connect to the network. Inverters can connect to a variety of devices, enabling use with versatile devices.

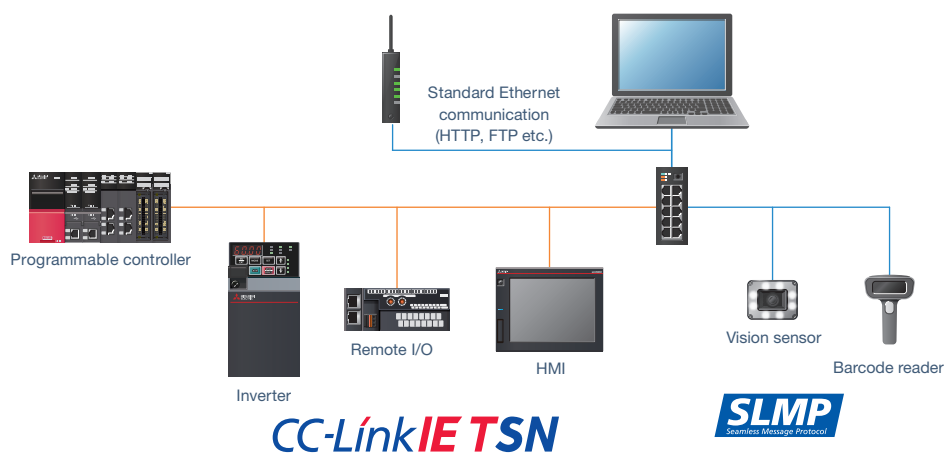

2 Compatibility with global networks

▶ Multi-protocols

Inverter models that support protocols of major global industrial Ethernet networks are available.

FR-E800 inverters support a variety of open networks without using any options, enabling the use of inverters on the existing network and assuring compatibility with various systems. Users can select a protocol group suitable for the intended system. It is possible to switch between protocols only by setting parameters. (Supported protocols differ depending on the model.)

Supported protocols

Model	CC-Link IE TSN (100 Mbps)*1	CC-Link IE Field Network Basic	MODBUS [®] /TCP	PROFINET	EtherNet/IP	BACnet/IP	EtherCAT
FR-E800-[]EPA	●	●	●	—	●	●	—
FR-E800-[]EPB	●	●	●	●	—	—	—
FR-E800-[]EPC	—	—	—	—	—	—	●

*1: 1 Gbps is optional (to be supported).

●: Supported



Design

Toward smart factory

Supporting various networks enable flexible system design.

3 Supporting various topologies

E800 E800-E E800-SCE

▶ Two Ethernet ports

Two Ethernet ports are provided as standard, enabling flexible connection in line topology without using a switching hub. Complex networks can be created just by connecting devices with a cable to a free port. The network can even accommodate changes in the specifications of devices.

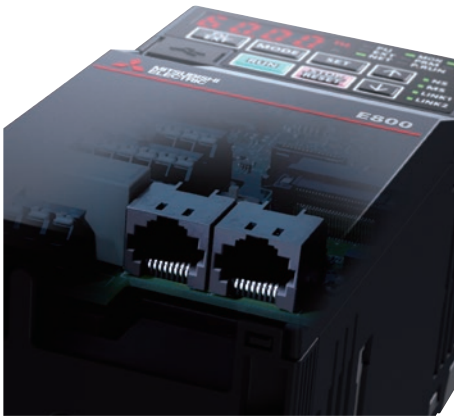

Line topology

The total wiring length can be minimized for large or extensive systems. Eliminating a switching hub allows more flexible installation of inverters even in a narrow space.

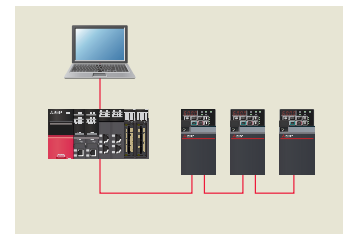

Star topology

A fault in one device does not affect other devices. Fast recovery is enabled when a fault occurs as it is easy to know which device is faulty.

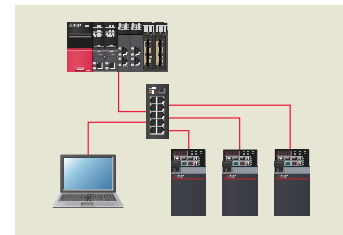

4 Enabling construction of a small-scale synchronous system of inverters

E800 E800-E E800-SCE

▶ Inverter-to-inverter link function

Communication between multiple inverters is carried out through the I/O device and special register transmission of the PLC function (refer to page 18). A small-scale system can be created by connecting multiple inverters via Ethernet. (The FR-A800-E inverter or the FR-F800-E inverter can be mixed in the system.)

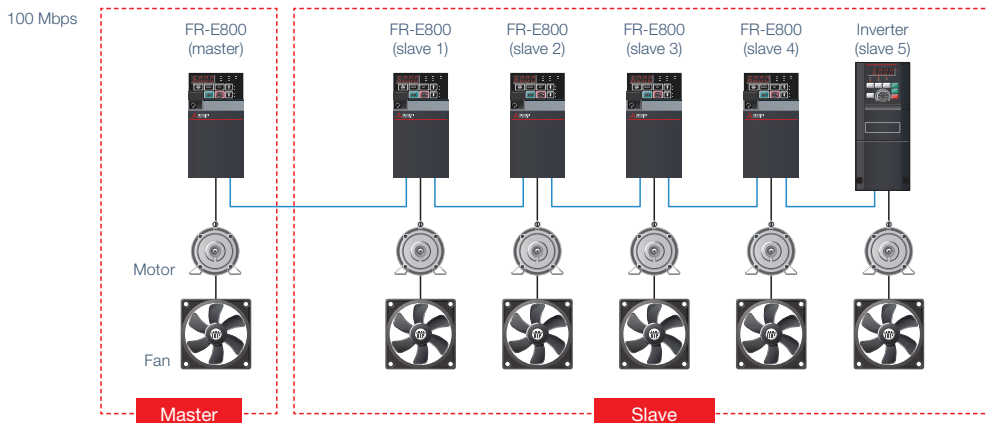

5 Simple configuration with less wiring using safety communication models

E800 E800-E E800-SCE

Safety communication model

Safety communication models support Ethernet-based safety communication protocols certified as compliant with international standards.

The safety control system on the existing network can be easily enhanced with less cost.

Model	CC-Link IE TSN Safety communication function	PROFIsafe	CIP Safety	FSoE (Safety over EtherCAT)
FR-E800-[]SCEPA	●	–	●	–
FR-E800-[]SCEPB	●	●	–	–
FR-E800-[]SCEPC	–	–	–	○

●: Supported ○: To be supported soon

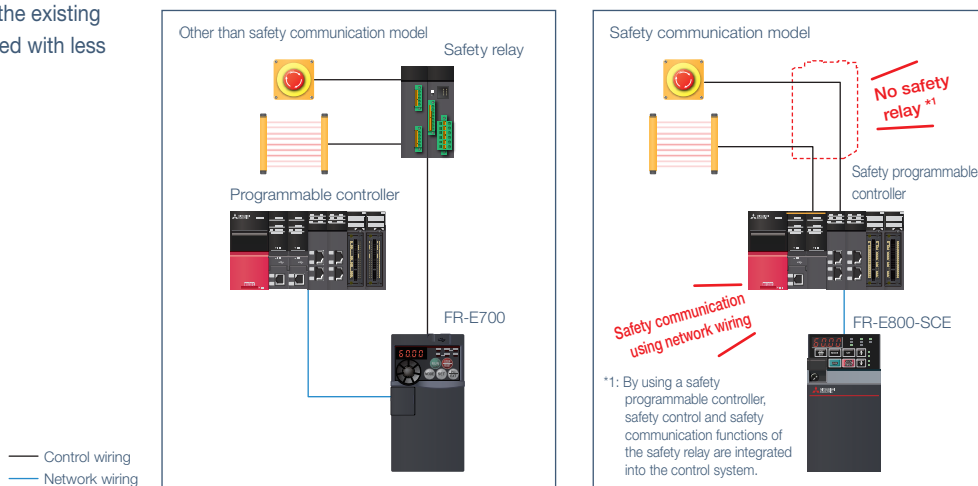

6 Security measures

E800 E800-E E800-SCE

IP filtering function (Ethernet)

Set the IP address range for connectable network devices to limit connectable devices.

The IP filtering function (Ethernet) is a means to prevent unwanted access from external devices, but it does not prevent it completely.

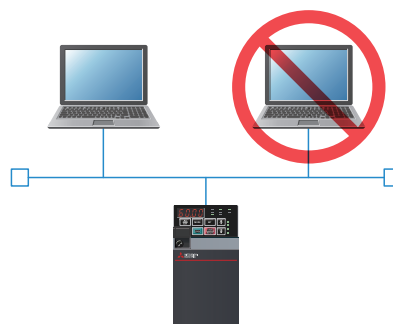

Ethernet command source selection

Devices which can control the inverter can be limited by setting the IP address range of the network device(s) used to operate it.

Ethernet function selection

Communication sockets are created only for selected applications to prevent unwanted access.

A communication socket is the interface for sending and receiving data on a specific port.

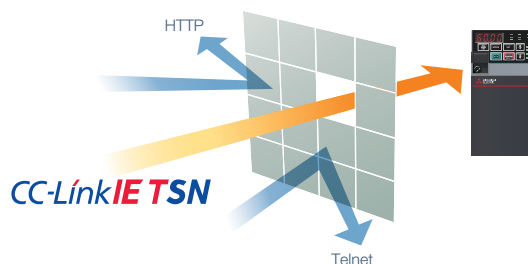



Design

Wide range of applications

The extended range of capacities and dimensions supports various applications.



1 Supporting various systems and environments

▶ Expanded capacity range

The product line of three-phase 200/400 V class inverters now includes up to 22K models. The capacity range is expanded as compared to the preceding FR-E700 inverters.

▶ Inverter power specifications

Three-phase 200/400/575 V and single-phase 200/100 V inverters support a wider range of motor power specifications.
(Three-phase 200/400/575 V motors can be driven.)

▶ Improved environmental resistance

Various applications are supported by allowing for corrosive environments or a wide range of surrounding air temperatures.

- Surrounding air temperatures between -20°C and 60°C^{*1} are supported. (-10°C to $+50^{\circ}\text{C}$ for the FR-E700)
- Inverters with circuit board coating (IEC 60721-3-3:1994 3C2)^{*2} are available for improved environmental resistance.

*1: Derating required for 50°C or higher.

*2: Coated model (-60/-06) only.

E800

E800-E

E800-SCE



Water treatment plant



Painting line

2 Effective solution for downsizing equipment

▶ Multiple rating

For the three-phase input model, two rating types of different rated current and permissible load can be selected by setting parameters. The choice of inverters is widened for intended applications of users. When users select the LD rating for light duty applications, inverters with smaller capacities can be used as compared to the FR-E700 series inverters. For example, when the LD rating (light duty) is selected for a 22K inverter, the inverter can drive a motor with a capacity up to 30 kW.

Load	Rating	Overload current rating
Light duty	LD rating	120% 60 s, 150% 3 s (inverse-time characteristics) at surrounding air temperature of 50°C
Normal duty	ND rating	150% 60 s, 200% 3 s (inverse-time characteristics) at surrounding air temperature of 50°C

E800 E800-E E800-SCE



Building water pumps

3 Optimizing the layout inside the enclosure

▶ Flexible installation

When the surrounding air temperature is 40°C or less, multiple inverters can be installed side-by-side. Users can select the most suitable layout for the intended installation area.



Side-by-side installation

E800 E800-E E800-SCE



Slicer

4 Enabling installation in various environments

▶ IP67 models (400 V class: 0.75K to 3.7K) To be supported soon

Installation outside of the enclosure enables installation closer to machines (FR-E846). Since the inverter is compatible with hostile environments such as high humidity and dusty environments, users can easily install the inverter near the machine or in available spaces.

It is possible to reduce line noise by shortening the wiring length between the inverter and the motor.

E800 E800-E E800-SCE



Automotive production line

5 Improving productivity with shorter tact time by the enhanced regeneration function

▶ Built-in brake transistor

With the enhanced power regeneration capability (brake duty: 100% max.), deceleration time can be shortened.*1

*1 : For 200 V class 0.4K and 0.75K models, the brake duty is 30% ED maximum when the lowest resistance value is used. The brake resistor must have a sufficient capacity to consume the regenerative power.

For 200 V class 0.1K and 0.2K models, brake transistors are not built in.

▶ Increased excitation deceleration

When the increased magnetic excitation deceleration function is used, the motor consumes the regenerative power and the deceleration time can be reduced without using a brake resistor. The tact time can be reduced for a transfer line or the like.

E800 E800-E E800-SCE



Automated warehouse



Airport baggage conveyor

3

Design

Higher added values

The outstanding drive performance and various functions create higher added values.



1 Customizing inverter operation for each machine

E800

E800-E

E800-SCE

▶ PLC function

In accordance with the machine specifications, users can set various operation patterns: inverter movements at signal inputs, signal outputs at particular inverter statuses, and monitor outputs, etc. Operation of the system can be customized by the inverter alone.

Parameters and setting frequency can be changed at the program. Control programs can be created in sequence ladders using the inverter setup software (FR Configurator2).

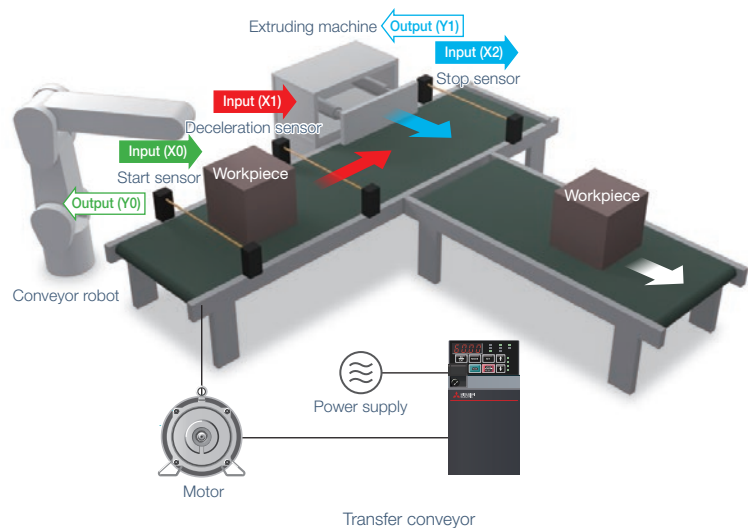

2 Same spare inverters for various applications

▶ Control method

Switching between control methods with the FR-E800 inverter, Vector control for lift application (with the plug-in option), Advanced magnetic flux vector control for conveyors, etc., reduces the number of required spare inverters.

E800	E800-E	E800-SCE
------	--------	----------

	Control	Speed control	Torque control	Position control	Motor
↑ Easy	V/F control	●	–	–	Induction motor (SF-PR, etc.)
	Advanced magnetic flux vector control	●	–	–	
	Real sensorless vector control	●	●	–	
↓ High-performance	PM sensorless vector control	●	–	●	PM motor (MM-GKR, EM-A)
	Vector control (with plug-in option FR-A8AP E kit used)	●	●	●	Induction motor (SF-PR-SC, SF-V5RU)

●: Supported

3 Accurate and stable transfer

▶ Position control

Positioning under Vector control is available. The cumulative pulse can be monitored, enabling accurate transfer of glass or PET bottles to the filling position.

Positioning function (point table method)

Position data (target position, speed, acceleration/deceleration time) and so on can be set in the parameters.

Positioning is possible for up to 7 points.

Positioning operation is performed by selecting point table numbers with external interface signals.

Continuous positioning is possible.

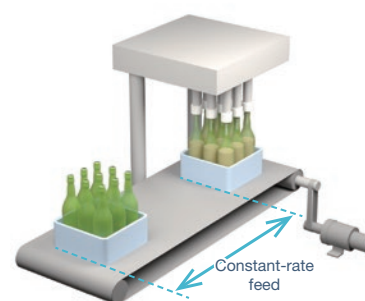

4 Improving work efficiency by powerful high-speed operation

▶ PM sensorless vector control

The torque is not reduced in the high-speed range (up to the rated speed) during PM sensorless vector control as compared with operation using a stepper motor. High-speed system operation improves the tact time. PM sensorless vector control is available when inverters are used with PM motors. High-level control such as positioning control is enabled without using an encoder. The PM motor offline auto tuning enables sensorless operation of other manufacturers' permanent magnet (PM) motors. (Tuning may be disabled depending on the motor characteristics.)

E800	E800-E	E800-SCE
------	--------	----------

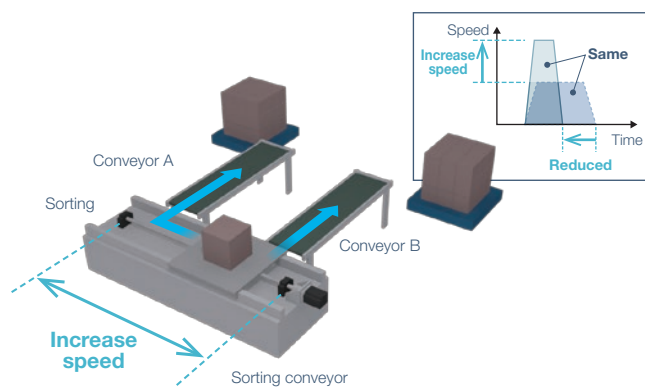

5 Expanding the range of applications using inverter options

▶ Plug-in options

In addition to the existing plug-in options to add digital inputs / analog outputs and to support different communication standards, the Vector control compatible option FR-A8AP E kit is supported. Among our compact inverters, the FR-E800 inverter is the first to support Vector control.

E800	E800-E	E800-SCE
------	--------	----------

FR-E800 inverter options

Model	Description
FR-A8AX E kit	16-bit digital input
FR-A8AY E kit	Digital output, additional analog output
FR-A8AR E kit	Relay output
FR-A8AP E kit	Vector control, encoder feedback control
FR-E8DS E kit	24VDC input
FR-A8NC E kit	CC-Link
FR-A8ND E kit	DeviceNet
FR-A8NP E kit	PROFIBUS-DP

4



Operation

Improved safety

Humans and FA devices can work together by enhancing functional safety.



1 Wireless access with hard-to-reach inverters

E800

E800-E

E800-SCE

▶ Ethernet communication

Even if inverters are located in a high place, narrow area, or other hard-to-reach place, wireless access enables adjustments of inverter parameters, inverter monitoring (simultaneous monitoring of multiple axes possible), and inverter maintenance such as life diagnosis checks.

The FR-E800 inverter can be connected to FR Configurator2 using a commercially-available industrial wireless LAN*1 access point.

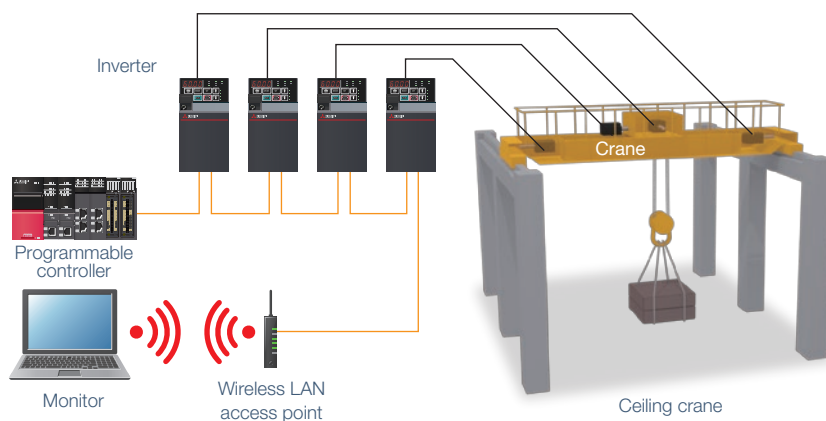

*1: A wireless LAN suitable for the industrial use in severe environments or in environments requiring high reliability (redundancy).

*2: Under certain environments or installation conditions, Ethernet communication through wireless LAN is not as stable as communication through wired LAN. Before starting operation, always check the communication status. Inverter operation (output shutoff, deceleration stop, etc.) when communication fails (due to reasons such as disconnection) can be selected by setting parameters. For applications requiring data transmission or update periodically or within a certain time period, a wired connection is recommended.

2 Attaining both safety and productivity

► Functional safety

The inverter is compliant with ISO 13849-1 and IEC 61508. This will contribute to reduction in the initial safety certification cost. Using the safety sub-functions compliant with IEC 61800-5-2 for the machinery or equipment will contribute to eliminate external devices or reduction in maintenance time, and ensure operators' safety. (Several conditions must be met to use this function.)

This will significantly reduce time required for maintenance or tooling and eliminate external devices such as ones used for monitoring the speed.

Use FR Configurator2 to set parameters related to the safety monitoring functions.

STO (safe torque off) function

Driving power to the motor is electronically shut off by responding to the input signal from external equipment.

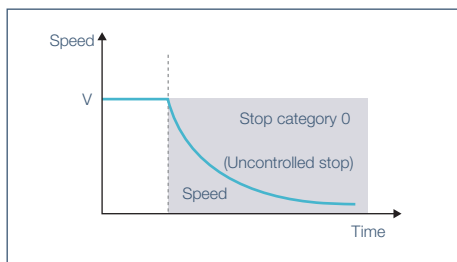

SLS (safely-limited speed) function

When an operator enters the limit area while a system is operating, operation of the system is not stopped and continues with a reduced speed.

The motor speed is calculated without using an encoder. This will contribute to wire and cost savings.

Several conditions must be met to use this function.

For details of operating conditions and risk assessment, refer to the Instruction Manual (Functional Safety).

For details including other safety monitoring functions, refer to the Instruction Manual (Functional Safety).

E800

E800-E

E800-SCE

Safety sub-function (IEC 61800-5-2)		Safety level (ISO 13849-1, IEC 61508)	SIL2, PLd, Cat.3	SIL3, PLe, Cat.3	SIL2, PLd, Cat.3
		FR-E800, FR-E800-E	FR-E800-SCE	FR-E700-SC	
STO	Safety torque off, coasting to stop	●	●	●	
SS1	Safe stop 1, deceleration monitoring	-	●	-	
SLS	Safely-limited speed	-	●	-	
SBC	Safe brake control	-	●	-	
SSM	Safe speed monitor	-	●	-	

●: Supported -/: Not supported

E800

E800-E

E800-SCE

Without STO function

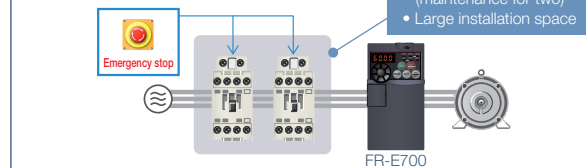

Use the STO function.

- Magnetic contactor (MC)
- Emergency stop wiring

Safety stop function (STO) cuts down the number of MCs to one! ^{*1}

- Cost reduction / low maintenance (maintenance for one)
- Small installation space

With STO function

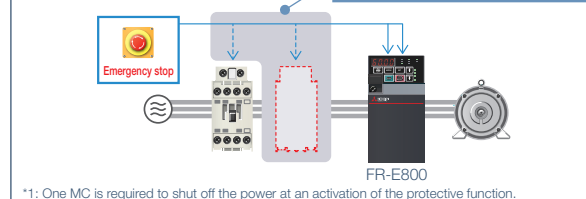

*1: One MC is required to shut off the power at an activation of the protective function.

E800

E800-E

E800-SCE

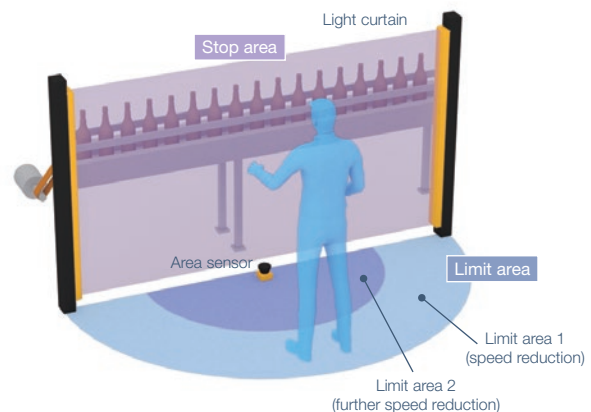



Use of induction motors or PM motors contributes to energy saving.



1 Energy saving with motors

E800

E800-E

E800-SCE

▶ General-purpose motor (SF-PR)

The Mitsubishi Electric SF-PR high-performance energy saving motor conforms to the Japanese domestic Top Runner Standard (IE3 equivalent). Its energy-saving operation contributes reduction in the electricity charges, which in turn lowers the running cost. Motor constants are stored in the inverter. Energy-saving operation can be started just by setting parameters.

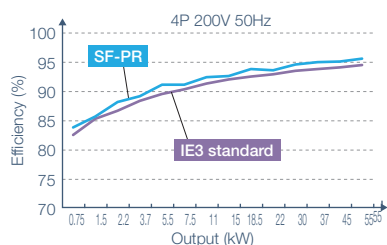

▶ PM motor (MM-GKR, EM-A)

The PM motor achieves even higher efficiency as compared to the general-purpose motor. The setting for driving PM motors is enabled just by setting parameters.

Why is a PM motor so efficient?

- No current flows to the rotor (secondary side), and no secondary copper loss is generated.
- Magnetic flux is generated with permanent magnets, and less motor current is required.

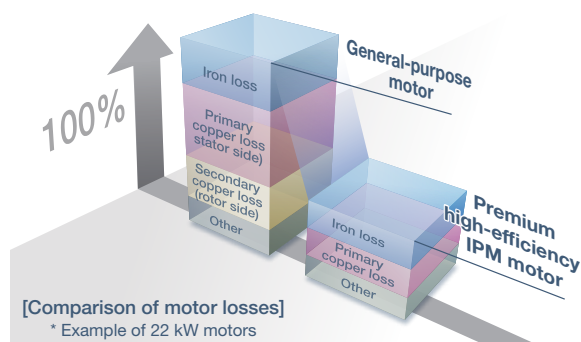

2 Supporting step-by-step energy saving solution

E800

E800-E

E800-SCE

► Compatibility with both induction motors and PM motors

Further energy saving operation is enabled by using IE3/IE4 induction motors or permanent magnet embedded (PM) motors. FR-E800 inverters support both induction motors and PM motors, enabling step-by-step replacement of existing devices. Users can replace inverters first and then motors. There is no need to replace them all at once.

Equipment investment in stages

1st Step

First, replace inverters.

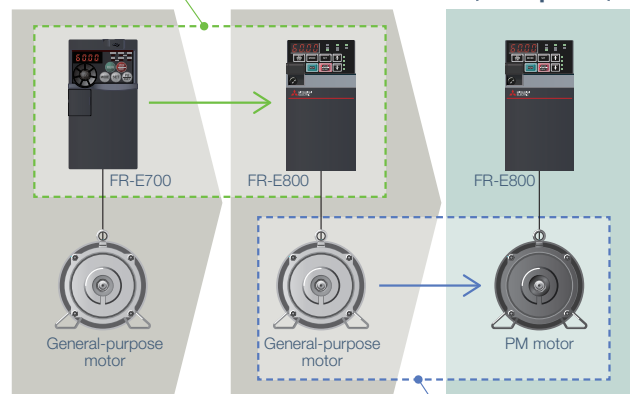

Update complete

2nd Step

Next, replace motors.

3 Energy saving with inverters

► Advanced optimum excitation control

A large starting torque can be provided with the same motor efficiency under Optimum excitation control. Without the need of troublesome adjustment of parameters (acceleration/deceleration time, torque boost, etc.), acceleration is done in a short time. Also, energy saving operation with the utmost improved motor efficiency is performed during constant-speed operation. When Advanced magnetic flux vector control is selected, Advanced optimum excitation control is available.

► Energy saving monitoring

The energy saving effect can be checked using an operation panel, output terminal, or network.

The output power amount measured by the inverter can be output in pulses. The cumulative power amount can be easily checked.*1

*1: This function cannot be used as a meter to certify electricity billings.

E800

E800-E

E800-SCE

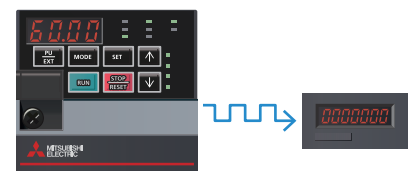
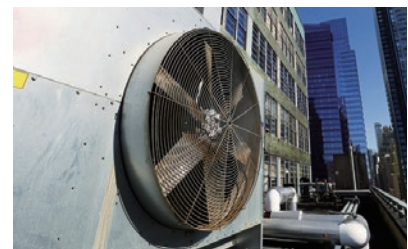

4 Energy saving with the regenerative option

► Power regeneration function (optional)

While the motor rotates to drive the machine during power driving, the machine rotates the motor during regenerative driving, which results in energy saving since the motor serves as a generator which returns the power to the power supply. By using the multifunction regeneration converter (FR-XC) as a common converter, the power returned from an inverter during regenerative drive can be supplied to another inverter, which in turn saves energy. Only the FR-XC in power regeneration mode is available for the FR-E800-SCE.

E800

E800-E

E800-SCE

[Power regeneration]

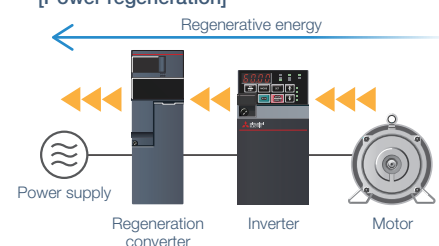

6



Maintenance

Improved maintainability

Functions for residual life diagnosis, predictive maintenance, and preventive maintenance support stable system operation.

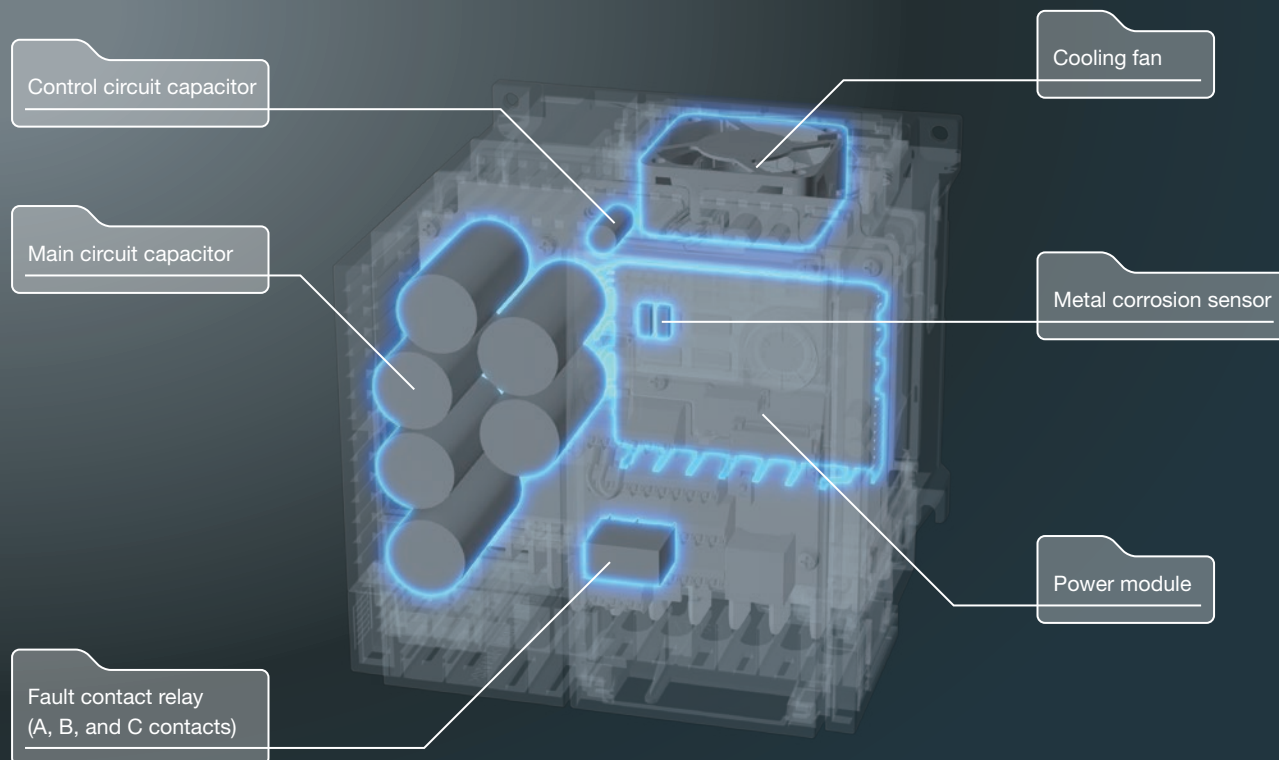

Example: FR-E840-3.7K

1 Real-time monitoring for early fault detection

E800

E800-E

E800-SCE

► Load characteristics fault detection function

When a mechanical fault such as clogging of the filter occurs, the inverter outputs a warning or shuts off the output to prevent system damage.

The speed-torque characteristic is stored while no fault occurs, enabling comparison between the measured data and the stored data.

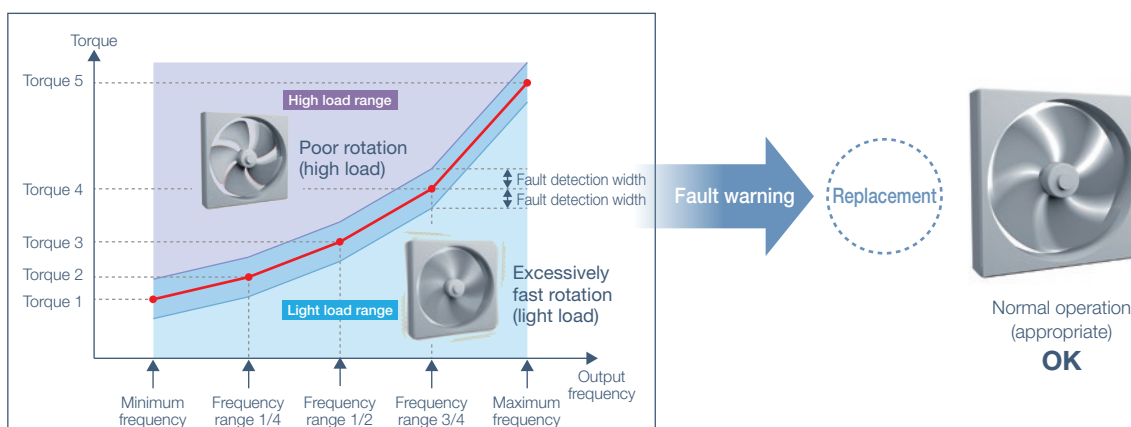

2 Supporting scheduled maintenance planning

▶ Environmental impact diagnosis function

The world's first*1 "Corrosive-Attack-Level Alert System (CALAS™)"*2 makes it possible to identify signs of inverter damage caused by corrosive gas such as hydrogen sulfide*3. This function notifies operators when factors such as the production environment need to be improved, resulting in reduction in the equipment downtime (for coated models (-60/-06) only).

The combined resistance of multiple metal corrosion sensors is measured to detect the level of degree of metal part corrosion caused by corrosive gas in the air.

The degree of corrosion (level 1 to 3) can be checked using a parameter, and a warning is output when level 3 is reached.

*1: According to our investigation as of September 10, 2019.

*2: Patent applied for.

Alert system for the risk of corrosive damage (degree of corrosion) of electrical equipment

*3: Others will be supported in future.

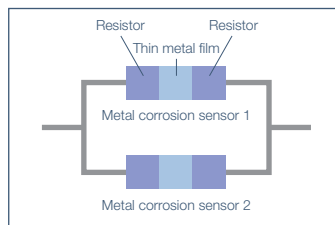

Schematic diagram of the metal corrosion sensor

E800 E800-E E800-SCE



Sewage treatment plant

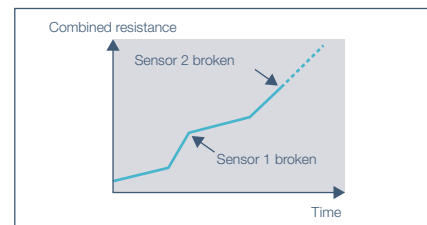

Example resistance value change detected by metal corrosion sensors

▶ Enhanced life diagnosis function

Availability of life diagnosis checks is extended as compared to the FR-E700 series. This enhanced diagnosis function ensures reliable operation of the system.

The design life of cooling fans and capacitors has been extended to 10 years*4.

*4: Surrounding air temperature: annual average 40°C (free from corrosive gas, flammable gas, oil mist, dust and dirt)
Output current: 80% of the inverter ND rating
Since the design life is a calculated value, it is not a guaranteed value.

Extended

- Main circuit capacitor residual-life estimation (available during operation)
- Inverter fault contact relay (A, B, and C contacts) life diagnosis*5
- Display power cycle life diagnosis
- Main circuit capacitor life diagnosis
- Control circuit capacitor life diagnosis
- Cooling fan life diagnosis
- Inrush current limit circuit life diagnosis

*5: Terminals A, B, and C of the inverter

3 Supporting preventive maintenance of peripherals

E800 E800-E E800-SCE

▶ Maintenance timer

The Maintenance timer signal is output when the inverter's cumulative energization time reaches the time period set with the parameter. This can be used as a guide for when the maintenance of the equipment should be conducted.

▶ PTC thermistor

The motor can be protected from overheating by inputting outputs from the motor's built-in PTC thermistor to the inverter.

4 Thorough customer support

E800 E800-E E800-SCE

▶ FA Center network

Our global network offers reliable technical support and customer satisfaction. (Refer to page 152.)

▶ Setup information web page

Our setup information web page provides easy access to manuals, videos, and outline dimension drawings. (Refer to page 34.)





Maintenance

Downtime reduction

When a fault occurs, AI analysis and other diagnosis functions solve the problem quickly.



Easy and fast wiring

1 Streamlining the installation process

▶ **Compatible installation size**

E800

E800-E

E800-SCE

The installation size was determined to assure exchangeability with the FR-E700 series. Installation interchange attachment options are available for facilitating replacement with the models of different size.

(The depth required for installation increases by 12 mm. Refer to page 99 for the details.)

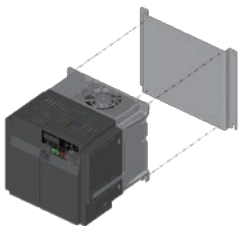

2 Easy and fast wiring

▶ **Control circuit terminal**

E800

E800-E

E800-SCE

- Spring clamp terminals have been adopted for control circuit terminals for easy wiring. Furthermore, wires can be protected against loosening or contact faults due to vibrations during operation on a bogie or during transport. No additional screw tightening is required.
- The removable control circuit terminal block facilitates replacement with a new one.

		FR-E800	FR-E800-E	FR-E800-SCE
Input terminal		7	2	0
Output terminal	Open collector	2	0	0
	Relay	1	1	1

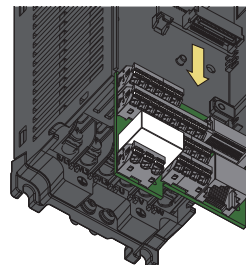

3 Troubleshooting supported by AI technology

E800

E800-E

E800-SCE

▶ AI fault diagnosis

The inverter is connected to the engineering software FR Configurator2 (USB/Ethernet connection). Maisart*1 (Mitsubishi Electric's AI technology) is integrated in the software to analyze data and help identify the cause of a fault*2 (this function is enabled during speed control).



Maisart

This function enables the fastest troubleshooting procedure without requiring any special skills, which contributes to downtime reduction.

*1: Maisart is Mitsubishi Electric's brand of AI technology. The name stands for "Mitsubishi Electric's AI creates the State-of-the-ART in technology". This means that it is using our proprietary AI technology to make everything smarter.

*2: Applicable fault: Overcurrent trip, overvoltage trip, inverter overload trip (electronic thermal relay function), motor overload trip (electronic thermal relay function). (Other faults will be applicable later.)

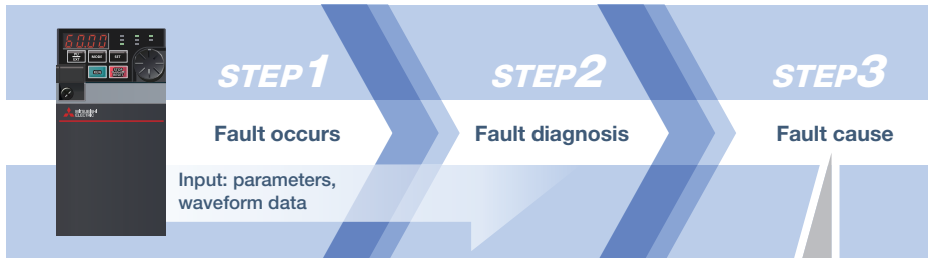

AI fault diagnosis result screen

Example: E.OCl (Overcurrent trip during acceleration)

Example: E.OCl (Overcurrent trip during acceleration)

FR-E820-0.4K(0030)-1 | **E.OCl (Overcurrent trip during acceleration)**

Output short circuit or main circuit failure in the inverter.

Turn OFF the power of the device and check the wiring.
Turn OFF the power of the device and check the wiring.

Offline auto tuning is not performed.

The motor constant parameter setting is improper.

Output phase loss.

Increase of the power driving load.

Cause

Insufficient torque in the present control method causes an overcurrent. As the stall prevention operation level is set too high of the fast-response current limit operation is disabled, an overcurrent occurs under heavy load conditions. The load of the machine driven by the motor gradually increases, resulting in an overcurrent.

Corrective action

Change the control method.
Lower the stall prevention operation level.
Enable the fast-response current limit function.
Eliminate the cause of the load increase.
Consider using a larger-capacity inverter and a larger-capacity motor.

Parameter	Name	Setting value	Factory setting	Min.	Max.	Resolution
Pr.01	Stall prevention operation level (stall prevention level)	0.000	0.000	0.000	0.000	0.000
Pr.02	Fast-response current limit operation level (stall prevention level)	0.000	0.000	0.000	0.000	0.000
Pr.03	Stall prevention operation level (stall prevention level)	0.000	0.000	0.000	0.000	0.000
Pr.04	Fast-response current limit operation level (stall prevention level)	0.000	0.000	0.000	0.000	0.000
Pr.05	Stall prevention operation level (stall prevention level)	0.000	0.000	0.000	0.000	0.000
Pr.06	Fast-response current limit operation level (stall prevention level)	0.000	0.000	0.000	0.000	0.000
Pr.07	Stall prevention operation level (stall prevention level)	0.000	0.000	0.000	0.000	0.000
Pr.08	Fast-response current limit operation level (stall prevention level)	0.000	0.000	0.000	0.000	0.000
Pr.09	Stall prevention operation level (stall prevention level)	0.000	0.000	0.000	0.000	0.000
Pr.10	Fast-response current limit operation level (stall prevention level)	0.000	0.000	0.000	0.000	0.000



Downtime reduction

When a fault occurs, AI analysis and other diagnosis functions solve the problem quickly.

4 Continuing the operation during a trouble

▶ Emergency drive (Fire mode)

The inverter can continue driving the motor in case of emergency such as a fire, since protective functions are not activated even if the inverter detects a fault.

Using this function may damage the motor or inverter because driving the motor is given the highest priority. Use this function for emergency operation only. The operation can be switched to the commercial power supply operation at the occurrence of a fault which may cause damage of the inverter.



5 Quick reaction to troubles

▶ Power supply from USB port

With the power supplied from the computer (USB bus power connection)*1, parameters can be set using FR Configurator2 while the main circuit power supply is OFF. Maintenance can be performed quickly and safely.

*1: The maximum SCCR should be 500 mA. A PU connector cannot be used during USB bus power connection.

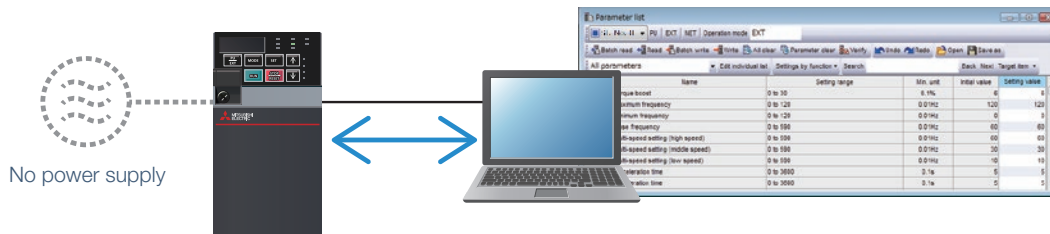

▶ 24 VDC input (FR-E8DS E kit)

Maintenance can be performed safely as the parameter setting and communication operation can be done while the main circuit power is OFF. (24 V external power supply operation) When a fault occurs, troubleshooting is facilitated as the fault indication remains after turning OFF the main circuit power supply.

Turning ON the main circuit power during the 24 V external power supply operation switches the operation to the normal operation. Before the operation is switched, a reset is performed in the inverter.

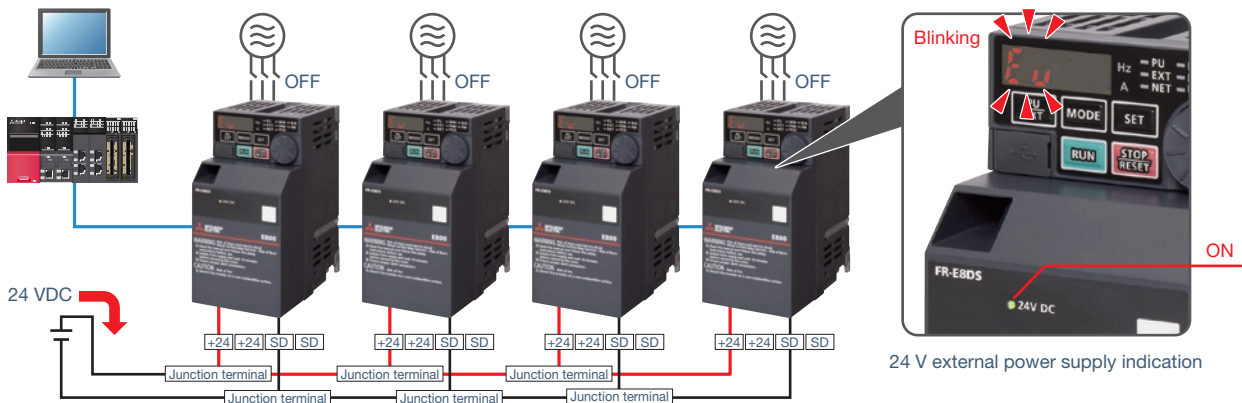

Up to four inverters can be connected in series.

6 Trouble analysis from a remote location

▶ Trace function

The operating status (output frequency or other data) immediately before the protective function is activated can be stored in a data file.

Users can read the data file in FR Configurator2 for graph display or send it by e-mail to someone away from the worksite, which facilitates the trouble analysis.

▶ Clock function

Setting the time*1 enables the user to specify the protective function activation time.

The date and time are also saved with the trace data, making the fault analysis easier.

Time synchronization via CC-Link IE TSN communication is available for the Ethernet model.

It is possible to synchronize the internal clocks of the devices that comprise the CC-Link IE TSN communication.

*1: The clock does not run while the control circuit power is OFF. The clock needs to be set every time after turning ON the inverter power.

By using the real-time clock function with the optional LCD operation panel (FR-LU08) (when using battery), the clock keeps running even when the control power supply is turned OFF.

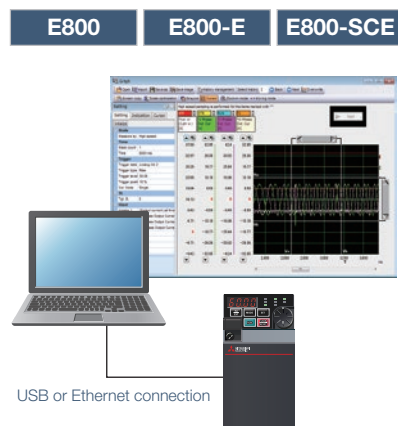



Engineering software for further ease of operation

The work efficiency can be improved for each of the design, operation, and maintenance processes.

1 FR Configurator2 for further ease of operation

E800 E800-E E800-SCE

Using FR Configurator2, easy-to-use software assisting anything from setup to maintenance, much more useful functions are available for users.

Free trial version Functions

The function with the marking above is available in the free trial version (usable free of charge with limited functions). It can be downloaded at Mitsubishi Electric FA Global Website.

Function	Free trial version	Function	Free trial version
Parameter list	○	I/O terminal monitor	×
Safety parameter setting (FR-E800-SCE)	○	Convert	△
Diagnosis	○	Developer	×
AI fault diagnosis	×	USB memory parameter copy file edit	×
Graph	×	Ethernet parameter setting	○
Batch monitor	×	iQSS backup file conversion	○
Test operation	○	Help	○

A full functional trial version, which has the same functionality as the release version, is also offered for a limited period of 30 days.
 ○ : Supported
 × : Not supported
 △ : To be supported

Life diagnosis check Free trial version Functions

Parts service life data is displayed in a dedicated window. A warning icon is shown in the alarm field of the parts recommended for replacement. This can be used as a guideline to replace long life parts.

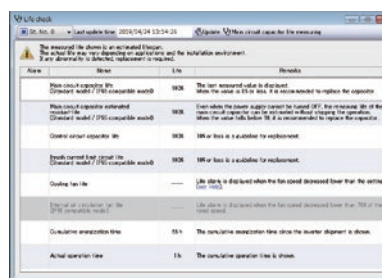

Graph function—trace function

Waveform graph data immediately before the protective function is activated can be automatically obtained. Graph display and log analysis are available using the stored trace data.



Ethernet parameter setting Free trial version Functions

Inverters in the same subnet mask are automatically detected, supporting easy network setting.

1) Detect supported devices.

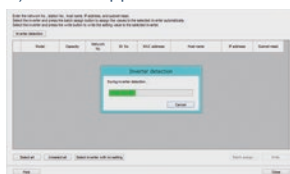

2) Enter the network No., station No., IP address, and subnet mask.

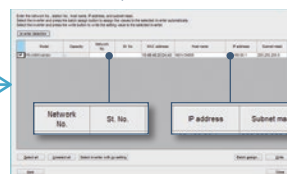

Setting complete

Diagnostics (Fault history)

Fault records in the inverter can be displayed. When the clock function or CC-Link IE TSN communication is used, the time of fault occurrence can be displayed, too. It is possible to check the occurrence time and the type of faults, which is helpful in identifying causes of faults.

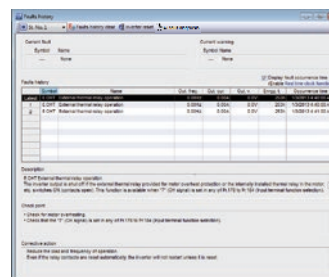

2 Further facilitating operation with your smartphone

E800

E800-E

E800-SCE

▶ Setup information web page

Users can scan the QR code on the product to directly access the setup information. Manuals, setup videos, and outline dimension drawings are available. (Refer to page 34.)

▶ Mobile app

E800

E800-E

E800-SCE

Wireless access with inverters from a remote location enables setting or changing of parameters, starting and stopping, and monitoring on the screen of mobile devices.

Users can easily monitor the inverter operation by checking data such as the running frequency and status of input and output terminals at a glance in one screen.

Wireless communication equipment must be prepared in the system that includes the inverter.

Operating status



Recognize inverters

Set Parameters

Check the fault history

Monitor

Download the free app now

Download on the App Store

GET IT ON Google Play



Engineering software for further ease of operation

The work efficiency can be improved for each of the design, operation, and maintenance processes.

3 Further facilitating operation with Drive System Sizing Software Motorizer

E800 E800-E E800-SCE

Users can select motors by entering data of mechanical configuration, specifications, and operating patterns. Applicable combinations include inverters, sensorless servo drive units, and AC servo amplifiers. The most suitable combination can be selected from the selection result. The software also supports multi-axis systems. Twelve types of load mechanism such as a ball screw or a rack and pinion are selectable. Selection is available by following the steps from 1 to 3. When users include the power regeneration common converter or other applicable converter, the capacity of the converter can be selected at the same time.

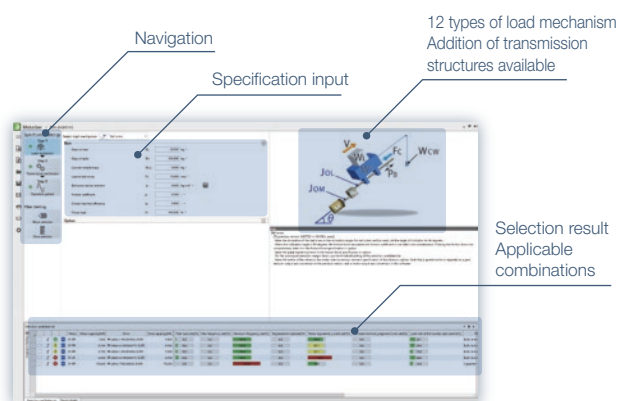

4 Further facilitating operation with the selection guide software

E800 E800-E E800-SCE

Advanced search for optimum inverters is available. Users can select inverters by entering data such as the motor capacity and current value and specifying specifications. The time spent on inverter selection can be reduced.

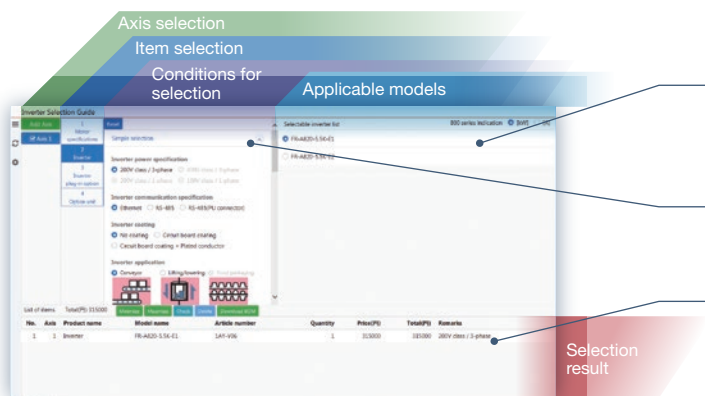

Applicable models will change in real time according to changes made to entries. Users do not have to fill all fields for selection. Applicable models will be selected according to the data entered.

Users can select the items to enter to set conditions for selection by folding or unfolding windows. Both easy setting and detailed setting are available.

Users can select one of the applicable models to register it as the selection result.

5 Further facilitating operation with Edgexcross

E800 E800-E E800-SCE

Inverters and the system are integrated by maximizing the use of production data with edge computing, enabling solutions for various issues including productivity improvement and equipment maintenance.

- Integration and processing of data sent from various devices and systems in production lines
- Real-time feedback to production sites
- Monitoring of field devices based on the know-how of production sites

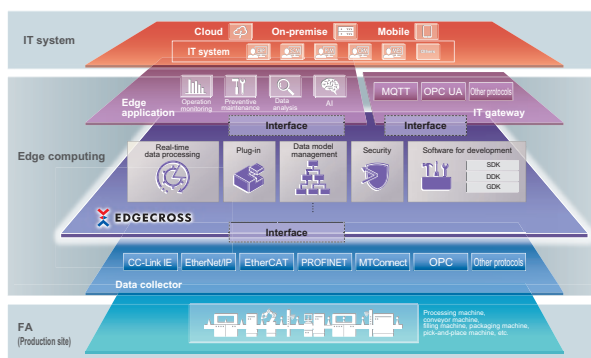

6 Further facilitating operation with GOT interaction functions

E800

E800-E

E800-SCE

GOT Drive

Enhanced compatibility between inverters and the GOT (human machine interface) brings various benefits to users.

Connection with the GOT2000 series can be established just by setting the station number. Other necessary settings are automatically done.

▶ Less time spent on screen design work by importing sample screens

To be supported soon

Various sample screens*1 are available to enable parameter setting, batch monitor, measurement of load characteristics and so on using the GOT.

Using sample screens enables easy startup of the system.

*1: Sample screens are included in the GT Works3 package, or can be downloaded at Mitsubishi Electric FA Global Website.

Sample screens are available for FR-E800 and FR-E800-E. FR-E800-SCE is to be supported.

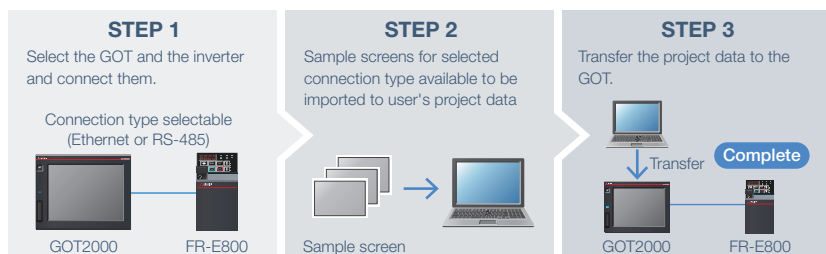

▶ Improving work efficiency without using a computer

Users can use the GOT to set up, adjust, and perform maintenance for inverters without using a computer.



▶ Immediate warning of system errors

By storing the data of relationship between the output frequency and the torque during normal inverter operation, users can judge whether the load is operating in normal condition. By outputting out-of-range warnings if applicable, users can detect mechanical faults or perform maintenance.

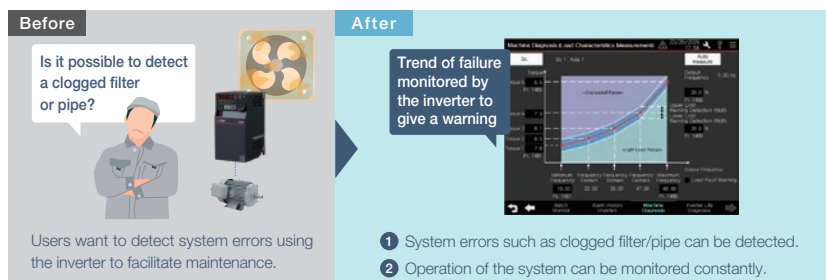

▶ Reducing downtime by interacting with the GOT

Faults occurred in the inverter can be displayed on the GOT screen. When a fault occurs, it is possible to identify the cause immediately, which contributes to downtime reduction.

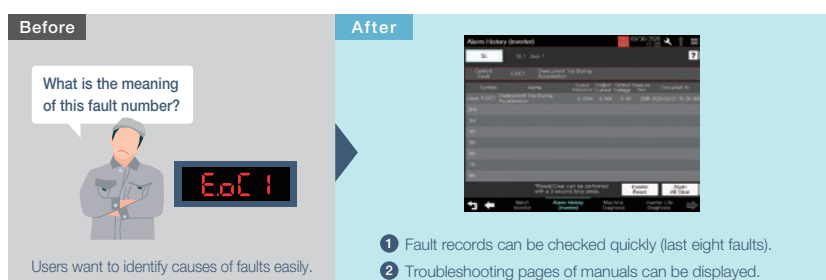

Scan the QR code to open the setup information web page



E800



E800-E



E800-SCE

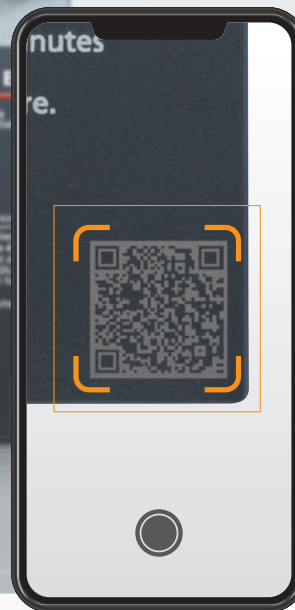

Scan the QR code to check how to use the product or browse manuals.



Helpful setup menu and videos



Installation and wiring



Videos [In preparation]



Basic operation

Examples



Faults



Outline dimension drawing



Inquiries



FAQ



Ready for reference



FR-E800 GUIDELINE



FR-E800(-E) Instruction Manual (Connection)



FR-E800(-E) Instruction Manual (Function)



FR-E800(-E) Instruction Manual (Communication)



FR-E800(-E) Instruction Manual (Maintenance)



FR-E800(-E) Instruction Manual (Functional Safety)

Dependable quality



Uniformity and consistency

The FR-E800 series product line offers more than fifty different designs. To integrate the unity of design, development of FR-E800 inverters started in accordance with common rules. They can be distinguished at a glance by their uniform characteristics of the details such as the bevel under the operation panel and the parting lines. Consistency with other Mitsubishi Electric FA products is also considered so that all the products look well-organized when they are placed together.



Prototype design / operation test



Unity of design for all models

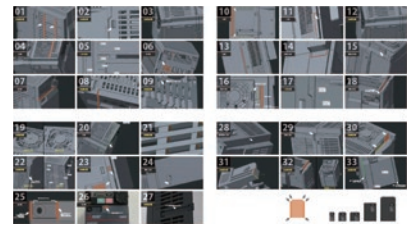

Detailed examination of the product design (development material)

Pursuing ease of operation

With the user-friendly design, ease of use is pursued for various installation and operating conditions (such as height of the device and operation with or without gloves). Owing to the contrast of colors and flat structure, tile buttons and the LED display are clear and easy to see.

Application examples

CASE 1 Smart factory

Problem

It is difficult to monitor the operating condition of the equipment due to the diversified.

Solution

The inverter supports various industrial networks. It is possible to select the inverter according to the existing network.

Multi-protocols

Users can select a group of protocols that includes CC-Link IE TSN, MODBUS/TCP, PROFINET, EtherNet/IP, and EtherCAT suitable for the intended system. It is possible to switch between protocols only by setting parameters. (Supported protocols differ depending on the product model.)

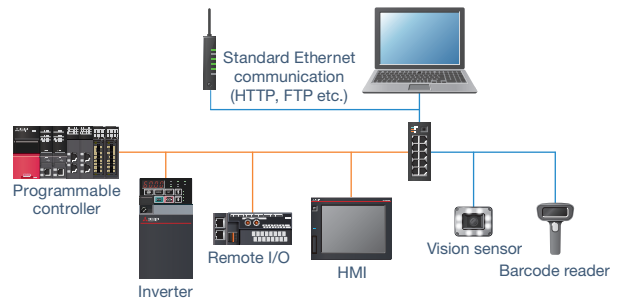

CASE 2 Fans

Problem

Is it possible to solve ventilation fan problems quickly?

Solution

AI-based troubleshooting reduces equipment downtime. The world's first environmental impact diagnosis function or other self-diagnostics allow early prevention or prediction of faults of the inverter or peripheral devices.



AI fault diagnosis

By connecting the inverter and a computer (USB or Ethernet), users can use FR Configurator2 to analyze data and help identify the cause of a fault. This diagnosis function enables the fastest troubleshooting procedure without requiring any special skills.



Problem

Is it possible to operate multiple fans together in the same duct?

Solution

Settings are available to select the stopping method to prevent each fan from being affected by other fans and the restarting method after instantaneous power failure.



Stop selection

The inverter can be set to coast the motor to a stop when multiple fans are used in the same duct to prevent each fan from being affected by rotation of other fans.

Automatic restart after instantaneous power failure

The frequency search is available at every start, enabling smooth starting even when the motor is coasting at a start.

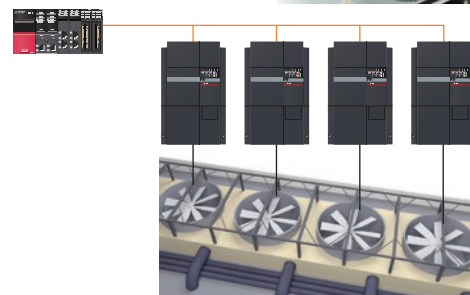

CASE 3 Transfer system

Problem

Is it possible to simplify the electric control system to use a smaller enclosure?

Solution

Inverter operations can be freely customized using the PLC function in the inverter. This function enables construction of various systems without using another controller.

PLC function

In accordance with the machine specifications, users can set various operation patterns: inverter movements at signal inputs, signal outputs at particular inverter statuses, and monitor outputs, etc. Operation of the system can be customized by the inverter alone.

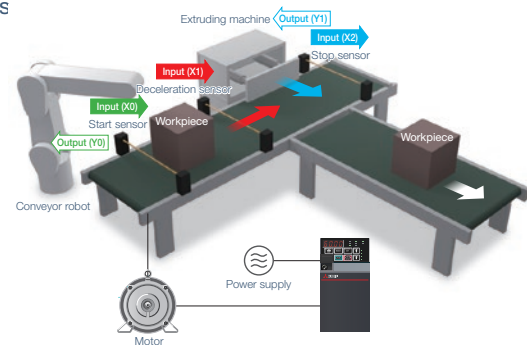

CASE 4 Food processing line

Problem

Is it possible to increase productivity while ensuring the safety of operators?

Solution

The inverter supports the IEC 61508-5-2 functional safety standard. This will significantly reduce time required for maintenance or tooling and eliminate external devices such as ones used for monitoring the speed.

SLS (safely-limited speed) function

It is possible to continue operation at a safe speed without stopping the production line. The motor speed is calculated based on the current value or other data without using an encoder. This will contribute to wire and cost savings.

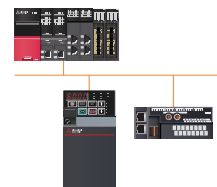
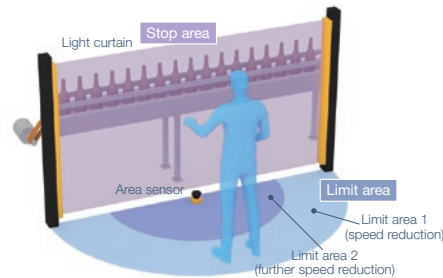

CASE 5 Cutting machine

Problem

Is it possible to reduce variation in the finished products?

Solution

Using PM sensorless vector control, the inverter contributes to reducing variation caused by uneven rotation.

PM sensorless vector control

The speed and magnetic pole positions, the two essential bits of information to control a PM motor, are detected without a sensor (encoder). The speed detection internally-performed in an inverter enables highly accurate control of a PM motor, almost as accurate as an AC servo system, without the need of a sensor (encoder).

Speed fluctuation ratio: $\pm 0.05\%$ (digital input)

Speed fluctuation ratio = $(\text{Speed under no load} - \text{Speed under rated load}) / \text{Rated speed} \times 100(\%)$

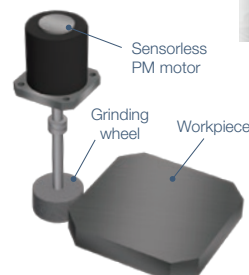

Application examples

CASE 6 Sprinkler

Problem

Is it possible to reduce the amount of water except for daytime hours?

Solution

The inverter has the PLC function to change its operation according to the weather or time of day.



PLC function

The inverter can be run in accordance with a sequence program. Inverter control such as inverter operations triggered by input signals, signal output based on inverter operation status, and monitor output can be freely customized based on the machine specifications.

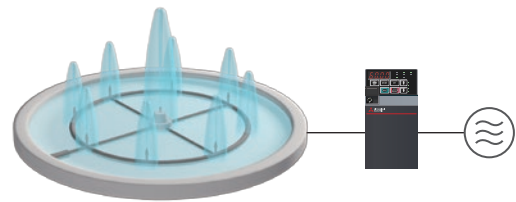

CASE 7 Food processing machine

Problem

Is it difficult to avoid sudden system failures due to corrosion even when the inverter with circuit board coating is used?

Solution

Using the environmental impact diagnosis function, it is possible to estimate the degree of circuit board corrosion. This enables timely preventive maintenance to reduce the equipment downtime.

Environmental impact diagnosis function

The detection circuit makes it possible to identify signs of inverter damage caused by corrosive gas (hydrogen sulfide). Equipment downtime will be reduced as the function notifies operators when the production environment needs to be improved (for coated models (-60/-06) only). No external instrument is needed to estimate the degree of corrosion in the inverter installation environment.

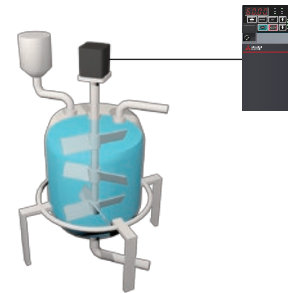

CASE 8 Automotive production line

Problem

Is it possible to set up or update the network easily?

Solution

Two Ethernet ports are provided as standard, enabling flexible connection in line topology without using a switching hub. Complex networks can be created just by connecting devices with a cable to a free port.

Line topology

The total wiring length can be minimized for large or extensive systems. Eliminating a switching hub allows more flexible installation of inverters even in a narrow space.

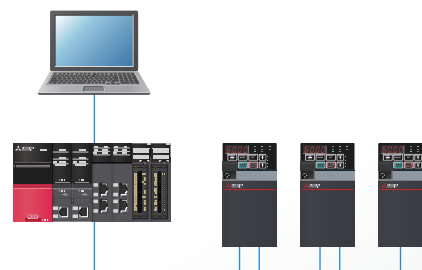

CASE 9 Pump

Problem

Is it possible to integrate the system control functions into the inverter without using another controller?

Solution

Inverter operations can be controlled using the PLC function in the inverter. This function enables construction of systems without using programmable controllers. This will contribute to cost reduction.







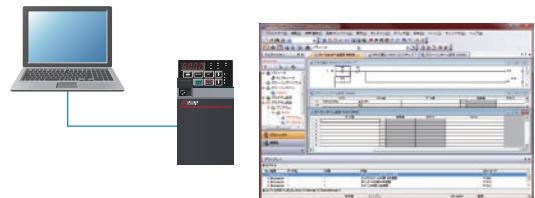





PLC function

In accordance with the machine specifications, users can set various operation patterns: inverter movements at signal inputs, signal outputs at particular inverter statuses, and monitor outputs, etc. Operation of the system can be customized by the inverter alone.



Differences with the FR-A800 series

Item			FR-E800	FR-A800
Control method	V/F control		✓	✓
	Advanced magnetic flux vector control		✓	✓
	Real sensorless vector control		✓	✓
	Vector control *1		✓	✓
	PM sensorless vector control		✓	✓
Control mode	Speed control		✓	✓
	Torque control		✓	✓
	Position control		✓ (Point table input 7 points)	✓ (Point table input 15 points, pulse train input to the inverter or the FR-ABAL plug-in option, SSCNET III(H) communication using the FR-ABNS plug-in option)
Starting torque	Induction motor	 150% 0.5 Hz  200% 0.3 Hz (3.7K or lower), 150% 0.3 Hz (5.5K or higher)	 200% 0.5 Hz (3.7K or lower), 150% 0.5 Hz (5.5K or higher)  SLD rating: 120% 0.3 Hz, LD rating: 150% 0.3 Hz, ND rating: 200%*2 0.3 Hz, HD rating: 250%*3 0.3 Hz	
	PM motor	 MM-GKR, EM-A: 200% Motor other than the above: 50%	 High frequency superposition control: 200% (when used with MM-CF, 200% for the 1.5 kW or lower, and 150% for the 2.0 kW or higher) Current synchronization operation: 50%	
Output frequency range			0.2 to 590 Hz*2	
Regenerative braking torque *4	Maximum value/ permissible duty*4		0.1K/0.2K...150%, 0.4K/0.75K...100%, 1.5K...50%, 2.2K or higher...20%	200 V class(ND rating)*5 : 0.4K to 1.5K...150%3%ED, 2.2K/3.7K...100%3%ED, 5.5K/7.5K...100%2%ED, 11K to 22K...20% continuous 400 V class(ND rating)*5 : 0.4K to 7.5K...100%2%ED, 11K to 22K...20% continuous
	Acceleration/deceleration time setting			0 to 3600 s
Individual acceleration/deceleration setting			Up to 2 types	Up to 3 types
Multi-speed			15 speeds	
Speed command	Analog		0 to 5 VDC, 0 to 10 VDC, 4 to 20 mA	
	Digital		Set with the operation panel or parameter unit*7. 4-digit BCD or 16-bit binary (when using the FR-ABAX plug-in option).	
Restart after instantaneous power failure			Available (frequency search method, reduced voltage method)	
Input signal	Contact input		[E800]: 7 [E800-E]: 2 [E800-SCE]: 0	12
	Pulse train input		—	100k pulses/s
Output signal	Open collector output		[E800]: 2 [E800-E] [E800-SCE]: 0	5
	Contact output (1 changeover contact)		1	2
Alarm output			1 changeover contact (230 VAC 2 A, 30 VDC 1 A), open collector output	
Fault code (4-bit) output			—	✓
Monitor function	Pulse train output		1440 pulses/s, 1 mA (FM type)	1440 pulses/s, 2 mA (FM type)
	Analog output		-10 to 10 VDC (AM type)	-10 to 10 VDC 0 to 20 mA DC (CA type)
Built-in communication function*6	RS-485 (Mitsubishi inverter protocol)			✓
	RS-485 (MODBUS®RTU)		✓[E800]	✓[A800] [A800-GF] [A800-GN]
	RS-485 (BACnet MS/TP)			—
	CC-Link IE TSN		✓[E800-EPA] [E800-EPB] [E800-SCEPA] [E800-SCEPB]	✓[A800-GN]
	CC-Link IE Field Network		—	✓[A800-GF]
	CC-Link IE Field Network Basic		✓[E800-EPA] [E800-EPB] [E800-SCEPA] [E800-SCEPB]	✓[A800-E]
	MODBUS/TCP			✓[A800-E]
	BACnet/IP		✓[E800-EPA] [E800-SCEPA]	—
	EtherNet/IP			✓(HMS network option)
	EtherCAT		✓[E800-EPC] To be supported [E800-SCEPC]	✓(HMS network option)
PROFINET		✓[E800-EPB] [E800-SCEPB]	✓(HMS network option)	
Safety monitoring functions	STO		✓	✓
	SS1, SLS, SBC, SSM		✓[E800-SCE]	—
	SS2, SOS		—	—
Safety communication function	CC-Link IE TSN Safety communication function		✓[E800-SCEPA] [E800-SCEPB]	To be supported
	CIP Safety		✓[E800-SCEPA]	—
	FSOE		To be supported [E800-SCEPC]	—
	PROFIsafe		✓[E800-SCEPB]	—

[E800]: Standard model, [E800-E]: Ethernet model, [E800-EPA]: Ethernet model (Protocol group A only), [E800-EPB]: Ethernet model (Protocol group B only), [E800-EPC]: Ethernet model (Protocol group C only), [E800-SCE]: Safety communication model, [E800-SCEPA]: Safety communication model (Protocol group A only), [E800-SCEPB]: Safety communication model (Protocol group B only), [E800-SCEPC]: Safety communication model (Protocol group C only)
[A800]: RS-485 model, [A800-E]: Ethernet model, [A800-GF]: CC-Link IE Field Network communication function type, [A800-GN]: CC-Link IE TSN communication function type

Item		FR-E800	FR-A800
Removable terminal block		Used for control circuit terminals	
Optional operation panel		Enclosure surface operation panel (FR-PA07)*7 Parameter unit (FR-PU07(BB))*7 LCD operation panel (FR-LU08)*7	Parameter unit (FR-PU07(BB)) LCD operation panel (FR-LU08)
Number of connectable plug-in options		1	3
USB	Function (computer connection)	✓	✓
	Host (USB memory device connection)	—	✓
	USB bus power	✓	—
Surrounding air temperature		200/400 V class: -20°C to +60°C (Derate the rated current when using the inverter in a temperature exceeding 50°C.) 575 V class: -10°C to +60°C (Derate the rated current when using the inverter in a temperature exceeding 50°C.)	200/400 V class: -10°C to +50°C (rating: LD/ND/HD) -10°C to +40°C (rating: SLD) 575 V class: FR-A860-00090 or lower: -10°C to +40°C (rating: LD/ND/HD) -10°C to +30°C (rating: SLD) FR-A860-00170 to 01080: -10°C to +40°C FR-A860-01440 or higher: -10°C to +50°C (rating: LD/ND) -10°C to +30°C (rating: SLD/HD)
Storage temperature		-40°C to +70°C	-20°C to +65°C

*1: Vector control is available when a Vector control compatible option is installed.

Item		FR-E800	FR-A800
Speed control	Speed control range	1: 1500	1: 1500
	Speed response	30 Hz	130 Hz
Torque control	Torque control range	1: 50	1: 50
	Absolute torque accuracy	±10%	±10%
	Repeated torque accuracy	±5%	±5%
Terminal response		10 ms	2 to 3 ms

*2: The upper frequency limit is 400 Hz under Advanced magnetic flux vector control, Real sensorless vector control, Vector control, and PM sensorless vector control.

*3: For the 5.5K or higher, the starting torque is initially limited to a level of 150% due to the torque limitation.

*4: The amount of regenerative braking torque is the average short-term torque (which varies depending on motor loss) that is generated when a motor decelerates in the shortest time by itself from the rated speed. It is not continuous regenerative torque.

When a motor decelerates from a speed higher than the rated speed, the average deceleration torque decreases. When the regenerative power is large, use an option brake unit. (Not available for 0.1K and 0.2K.)

*5: For the regenerative braking torque for the 30K or higher or when the option is connected, refer to the FR-A800 inverter catalog.

*6: Refer to the relevant inverter catalog for other available communication functions or communication functions supported by options.

*7: The optional operation panel / parameter unit is available for the standard model.

List of inverters by rating

Three-phase 200 V class

Model FR-E820-[]		Applicable motor capacity (kW) ^{*1}	
		LD	ND
0.1K	0008	0.2	0.1
0.2K	0015	0.4	0.2
0.4K	0030	0.75	0.4
0.75K	0050	1.1	0.75
1.5K	0080	2.2	1.5
2.2K	0110	3	2.2
3.7K	0175	5.5	3.7
5.5K	0240	7.5	5.5
7.5K	0330	11	7.5
11K	0470	15	11
15K	0600	18.5	15
18.5K	0760	22	18.5
22K	0900	30	22

Three-phase 400 V class

Model FR-E840-[]		Applicable motor capacity (kW) ^{*1}	
		LD	ND
0.4K	0016	0.75	0.4
0.75K	0026	1.5	0.75
1.5K	0040	2.2	1.5
2.2K	0060	3	2.2
3.7K	0095	5.5	3.7
5.5K	0120	7.5	5.5
7.5K	0170	11	7.5
11K	0230	15	11
15K	0300	18.5	15
18.5K	0380	22	18.5
22K	0440	30	22

Three-phase 575 V class

Model FR-E860-[]		Applicable motor capacity (kW) ^{*1}	
		LD	ND
0.75K	0017	1.5	0.75
1.5K	0027	2.2	1.5
2.2K	0040	3.7	2.2
3.7K	0061	5.5	3.7
5.5K	0090	7.5	5.5
7.5K	0120	11	7.5

Single-phase 200 V class

Model FR-E820S-[]		Applicable motor capacity (kW) ^{*1}
		ND
0.1K	0008	0.1
0.2K	0015	0.2
0.4K	0030	0.4
0.75K	0050	0.75
1.5K	0080	1.5
2.2K	0110	2.2

Overload current rating

LD	120% 60 s, 150% 3 s (inverse-time characteristics) at surrounding air temperature of 50°C
ND	150% 60 s, 200% 3 s (inverse-time characteristics) at surrounding air temperature of 50°C

*1: The motor capacity indicates the maximum capacity of a 4-pole standard motor driven by all of the inverters in parallel connection.

To drive a Mitsubishi Electric high-performance energy-saving motor, use the 200 V class 0.75K inverter for a 1.1 kW motor, or 200/400 V class 2.2K inverter for a 3 kW motor.

Single-phase 100 V class

Model FR-E810W-[]		Applicable motor capacity (kW) ^{*1}
		ND
0.1K	0008	0.1
0.2K	0015	0.2
0.4K	0030	0.4
0.75K	0050	0.75

Lineup

For the details of the lineup, please contact your sales representative.

Model

► Standard model

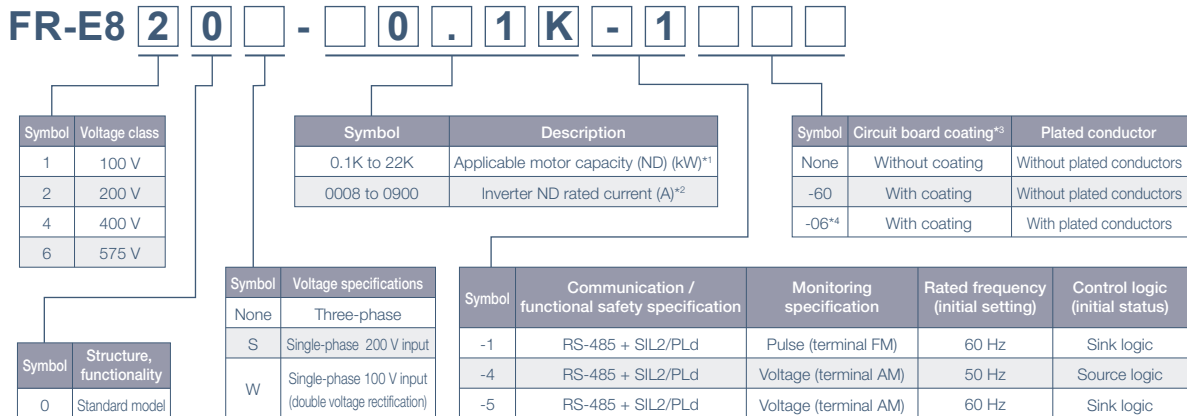

*1: Combination with the specification type -1(-60/-06) or -5 is available.

(When the kW indication is required for the product, purchase the model with a suffix "-5" and change the initial settings with reference to the Instruction Manual. (Refer to the Instruction Manual (Connection) for the switching of the control logic of the inverter, and the Instruction Manual (Function) for the rated frequency.))

*2: Combination with the specification type -4-60, -4-06, -5-60, or -5-06 is available.

*3: Compatible with IEC 60721-3-3:1994 3C2.

*4: Applicable for the FR-E820-0470(11K) or higher, and the FR-E840-0380(18.5K) or higher.

► Ethernet model

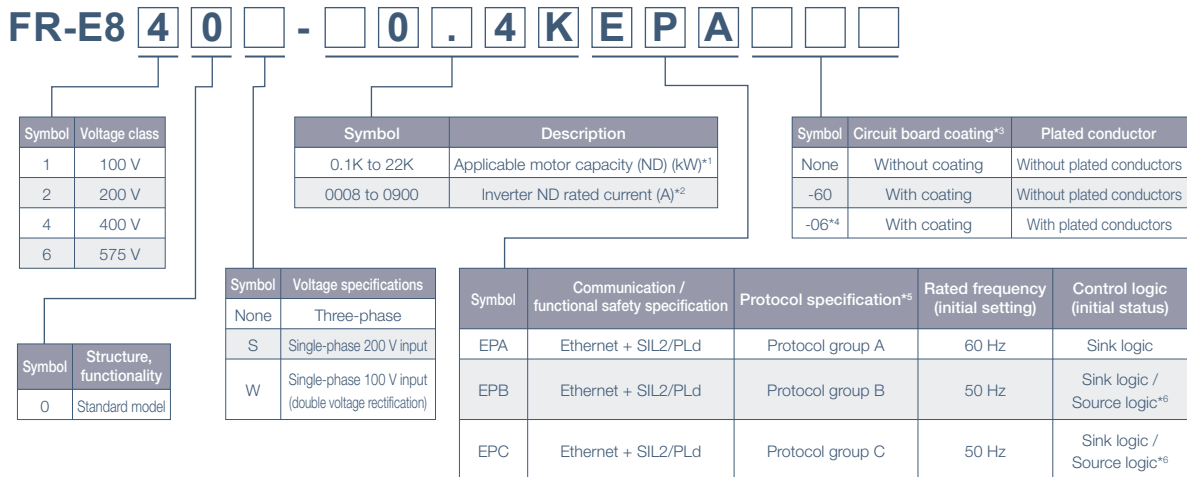

*1: Combination with the specification type EPA(-60/-06) or EPB(-60/-06) is available.

*2: Combination with the specification type EPA-60, EPA-06, EPB-60, or EPB-06 is available.

*3: Compatible with IEC 60721-3-3:1994 3C2.

*4: Applicable for the FR-E820-0470(11K) or higher, and the FR-E840-0380(18.5K) or higher.

*5: Selectable protocols differ depending on the group.

Protocol group A: CC-Link IE TSN, CC-Link IE Field Network Basic, MODBUS/TCP, EtherNet/IP, and BACnet/IP

Protocol group B: CC-Link IE TSN, CC-Link IE Field Network Basic, MODBUS/TCP, and PROFINET

Protocol group C: EtherCAT

*6: The initial status of the control logic differs depending on the inverter model.

Sink logic for the models indicated with the applicable motor capacity (kW)

Source logic for the models indicated with the rated current (A)

Safety communication model

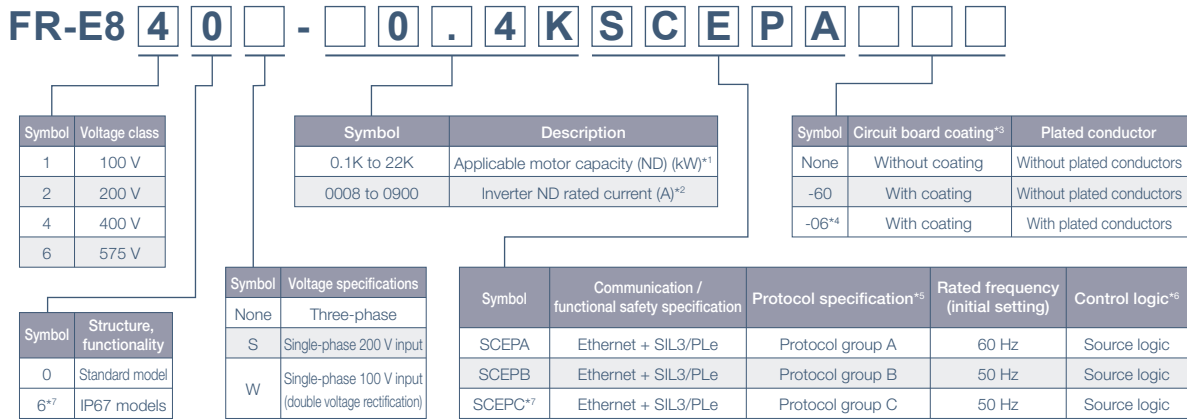

*1: Combination with the specification type SCEPA(-60/-06) or SCEPB(-60/-06) is available.
 *2: Combination with the specification type SCEPA-60, SCEPA-06, SCEPB-60, or SCEPB-06 is available.
 *3: Compatible with IEC 60721-3-3:1994 3C2
 *4: Applicable for the FR-E820-0470(11K) or higher, and the FR-E840-0380(18.5K) or higher.
 *5: Selectable protocols differ depending on the group.
 Protocol group A: CC-Link IE TSN, CC-Link IE Field Network Basic, MODBUS/TCP, EtherNet/IP, and BACnet/IP
 Protocol group B: CC-Link IE TSN, CC-Link IE Field Network Basic, MODBUS/TCP, and PROFINET
 Protocol group C: EtherCAT
 *6: The control logic is fixed to the source logic.
 *7: To be released

Capacity table

	0.1K	0.2K	0.4K	0.75K	1.5K	2.2K	3.7K	5.5K	7.5K	11K	15K	18.5K	22K
Three-phase 200 V	0008	0015	0030	0050	0080	0110	0175	0240	0330	0470	0600	0760	0900
FR-E820-[(E)/SCE]	●	●	●	●	●	●	●	●	●	●	●	●	●
Three-phase 400 V	-	-	0.4K	0.75K	1.5K	2.2K	3.7K	5.5K	7.5K	11K	15K	18.5K	22K
FR-E840-[(E)/SCE]	-	-	0016	0026	0040	0060	0095	0120	0170	0230	0300	0380	0440
Three-phase 575 V	-	-	-	0.75K	1.5K	2.2K	3.7K	5.5K	7.5K	-	-	-	-
FR-E860-[(E)/SCE]	-	-	-	0017	0027	0040	0061	0090	0120	-	-	-	-
Single-phase 200 V	0.1K	0.2K	0.4K	0.75K	1.5K	2.2K	-	-	-	-	-	-	-
FR-E820S-[(E)/SCE]	0008	0015	0030	0050	0080	0110	-	-	-	-	-	-	-
Single-phase 100 V	0.1K	0.2K	0.4K	0.75K	-	-	-	-	-	-	-	-	-
FR-E810W-[(E)/SCE]	0008	0015	0030	0050	-	-	-	-	-	-	-	-	-

● : Released, — : Not applicable



For differences between the standard model (E800), Ethernet model (E800-E), and safety communication model (E800-SCE), refer to page 148.

Operation Panel

● Components of the operation panel

E800

The operation panel cannot be removed from the inverter.

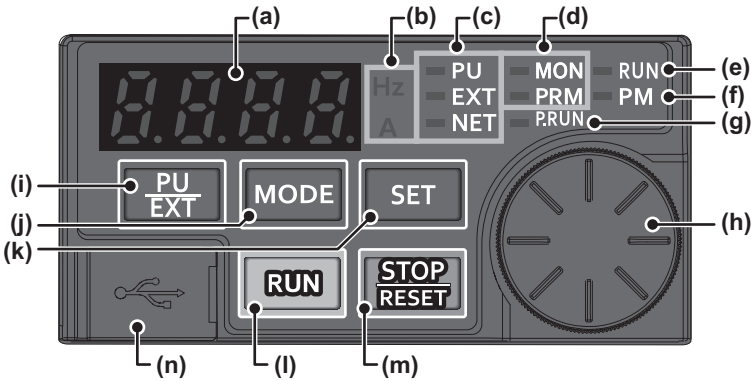

No.	Appearance	Name	Description
(a)		Monitor (4-digit LED)	Shows a numeric value (readout) of a monitor item such as the frequency or a parameter number. (The monitor item can be changed according to the settings of Pr.52, Pr.774 to Pr.776.)
(b)		Unit indication	Hz: ON when the actual frequency is monitored. (Blinks when the set frequency is monitored.) A: ON when the current is monitored. (Both "Hz" and "A" are OFF to indicate a value other than the frequency or the current.)
(c)		Inverter operation mode LED indicator	PU: ON when the inverter is in the PU operation mode. EXT: ON when the inverter is in the External operation mode. (ON when the inverter in the initial setting is powered ON.) NET: ON when the inverter is in the Network operation mode. PU and EXT: ON when the inverter is in the External/PU combined operation mode 1 or 2.
(d)		Operation panel mode LED indicator	MON: ON or blinks only when the first, second, or third monitor is displayed. PRM: ON when the operation panel is in the parameter setting mode. The indicator blinks when the inverter is in the easy setting mode.
(e)		Operating status indicator	ON or blinks during inverter running. ON: During forward rotation operation. Blinks slowly (1.4-second cycle): During reverse rotation operation. Blinks quickly (0.2-second cycle): Operation is disabled although the start command is given.*1
(f)		Controlled motor type LED indicator	ON when the inverter is set to control the PM motor. The indicator blinks during test operation. The indicator is OFF when the inverter controls the induction motor.
(g)		PLC function LED indicator	ON when the PLC function of the inverter is valid. (The indicator blinks when a fault occurs while the PLC function is valid.)
(h)		Setting dial	The setting dial of the Mitsubishi Electric inverters. Turn the setting dial to change the setting of frequency or parameter, etc. Press the setting dial to perform the following operations: To display a set frequency on the LED display in the monitor mode. (The monitor item shown on the display can be changed by using Pr.992.) To display the present setting during calibration.
(i)		PU/EXT key	Switches between the PU operation mode, the PUJOG operation mode, and the External operation mode. The easy setting of the inverter operation mode is enabled by pressing this key simultaneously with the MODE key. Also cancels the PU stop warning.
(j)		MODE key	Switches the operation panel to a different mode. The easy setting of the inverter operation mode is enabled by pressing this key simultaneously with the PU/EXT key. Every key on the operation panel becomes inoperable by holding this key for 2 seconds. The key inoperable function is invalid when Pr.161 = "0 (initial setting)".
(k)		SET key	Confirms each selection. When this key is pressed during inverter operation, the monitor item changes. (The monitor item on each screen can be changed according to the settings of Pr.52, Pr.774 to Pr.776.)
(l)		RUN key	Start command The direction of motor rotation depends on the Pr.40 setting.
(m)		STOP/RESET key	Stops the operation commands. Used to reset the inverter when the protective function is activated.
(n)		USB connector	FR Configurator2 is available by USB connection.

*1 Situations such as when the MRS/X10 signal is input, during the automatic restart after instantaneous power failure, after auto tuning is complete, when "SE" (incorrect parameter setting) alarm occurs.

● Basic operation of the operation panel

E800

1

Operation Panel, Operation Steps

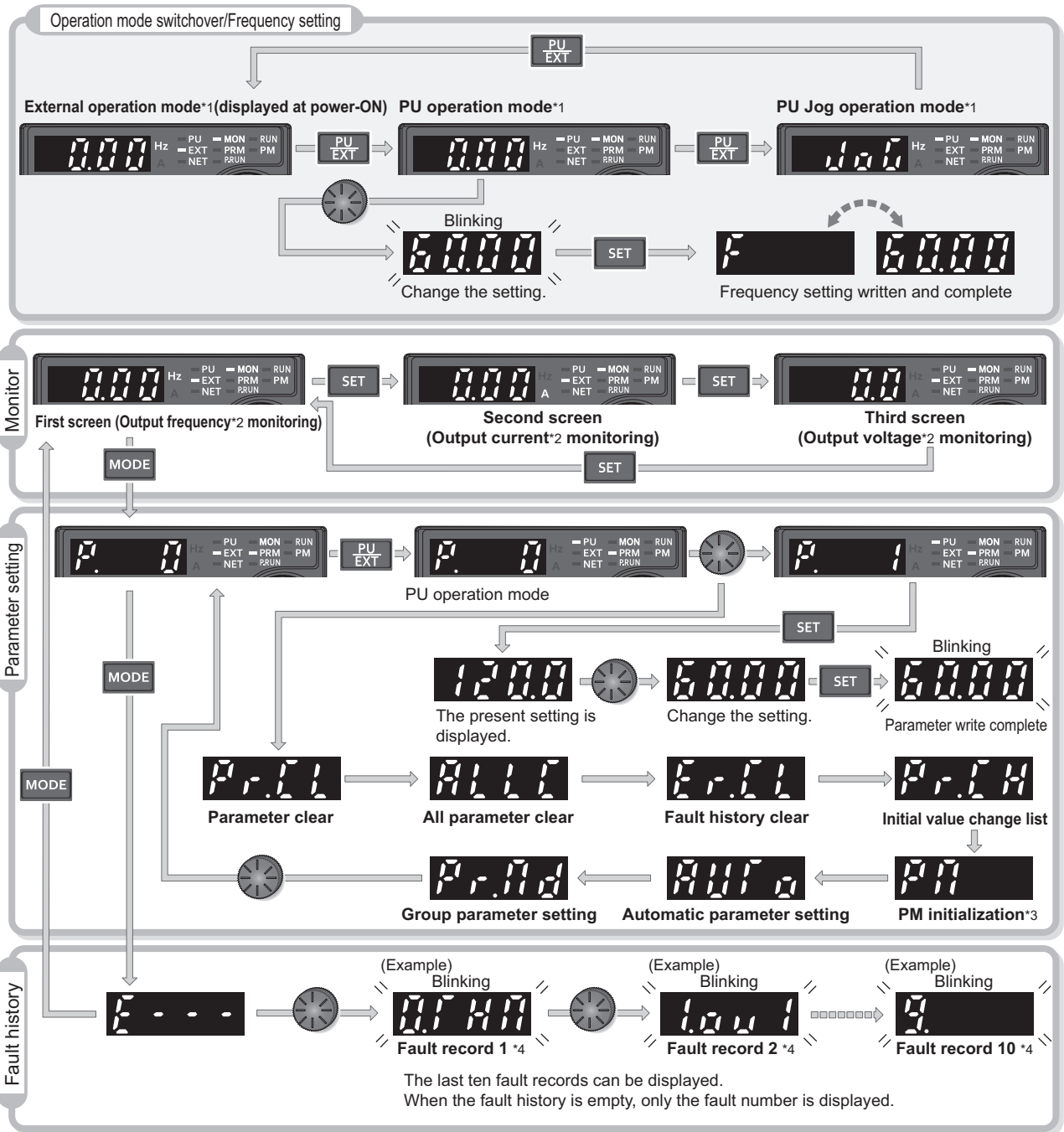

*1 For the details of operation modes, refer to the Instruction Manual (Function).
 *2 The monitor item can be changed. (Refer to the Instruction Manual (Function).)
 *3 Not displayed for the 575 V class.
 *4 For the details of the fault history, refer to the Instruction Manual (Maintenance).

● Components of the operation panel

E800-E

E800-SCE

The operation panel cannot be removed from the inverter.

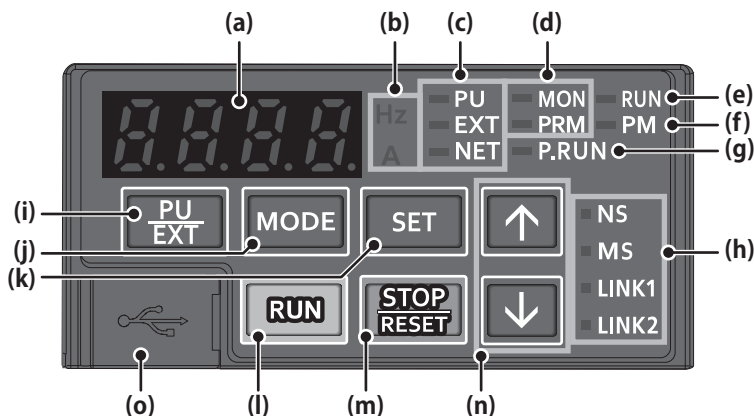

No.	Appearance	Name	Description
(a)		Monitor (4-digit LED)	Shows a numeric value (readout) of a monitor item such as the frequency or a parameter number. (The monitor item can be changed according to the settings of Pr.52, Pr.774 to Pr.776.)
(b)		Unit indication	Hz: ON when the actual frequency is monitored. (Blinks when the set frequency is monitored.) A: ON when the current is monitored. (Both "Hz" and "A" are OFF to indicate a value other than the frequency or the current.)
(c)		Inverter operation mode LED indicator	PU: ON when the inverter is in the PU operation mode. EXT: ON when the inverter is in the External operation mode. NET: ON when the inverter is in the Network operation mode. (ON when the inverter in the initial setting is powered ON.) PU and EXT: ON when the inverter is in the External/PU combined operation mode 1 or 2.
(d)		Operation panel mode LED indicator	MON: ON or blinks only when the first, second, or third monitor is displayed. PRM: ON when the operation panel is in the parameter setting mode. The indicator blinks when the inverter is in the easy setting mode.
(e)		Operating status indicator	ON or blinks during inverter running. ON: During forward rotation operation. Blinks slowly (1.4-second cycle): During reverse rotation operation. Blinks quickly (0.2-second cycle): Operation is disabled although the start command is given.*1
(f)		Controlled motor type LED indicator	ON when the inverter is set to control the PM motor. The indicator blinks during test operation. The indicator is OFF when the inverter controls the induction motor.
(g)		PLC function LED indicator	ON when the PLC function of the inverter is valid. (The indicator blinks when a fault occurs while the PLC function is valid.)
(h)		Ethernet communication status	Indicates the Ethernet communication status. For details, refer to the Instruction Manual (Communication).
(i)		PU/EXT key	Switches between the PU operation mode, the PUJOG operation mode, and the Network operation mode. The easy setting of the inverter operation mode is enabled by pressing this key simultaneously with the MODE key. Also cancels the PU stop warning.
(j)		MODE key	Switches the operation panel to a different mode. The easy setting of the inverter operation mode is enabled by pressing this key simultaneously with the PU/EXT key. Every key on the operation panel becomes inoperable by holding this key for 2 seconds. The key inoperable function is invalid when Pr.161 = "0 (initial setting)".
(k)		SET key	Confirms each selection. When this key is pressed during inverter operation, the monitor item changes. (The monitor item on each screen can be changed according to the settings of Pr.52, Pr.774 to Pr.776.)
(l)		RUN key	Start command The direction of motor rotation depends on the Pr.40 setting.
(m)		STOP/RESET key	Stops the operation commands. Used to reset the inverter when the protective function is activated.
(n)		UP/DOWN key	Used to change the setting of frequency or parameter.
(o)		USB connector	FR Configurator2 is available by USB connection.

*1 Situations such as when the MRS/X10 signal is input, during the automatic restart after instantaneous power failure, after auto tuning is complete, when "SE" (incorrect parameter setting) alarm occurs.

Basic operation of the operation panel

E800-E

E800-SCE

1

Operation Panel, Operation Steps

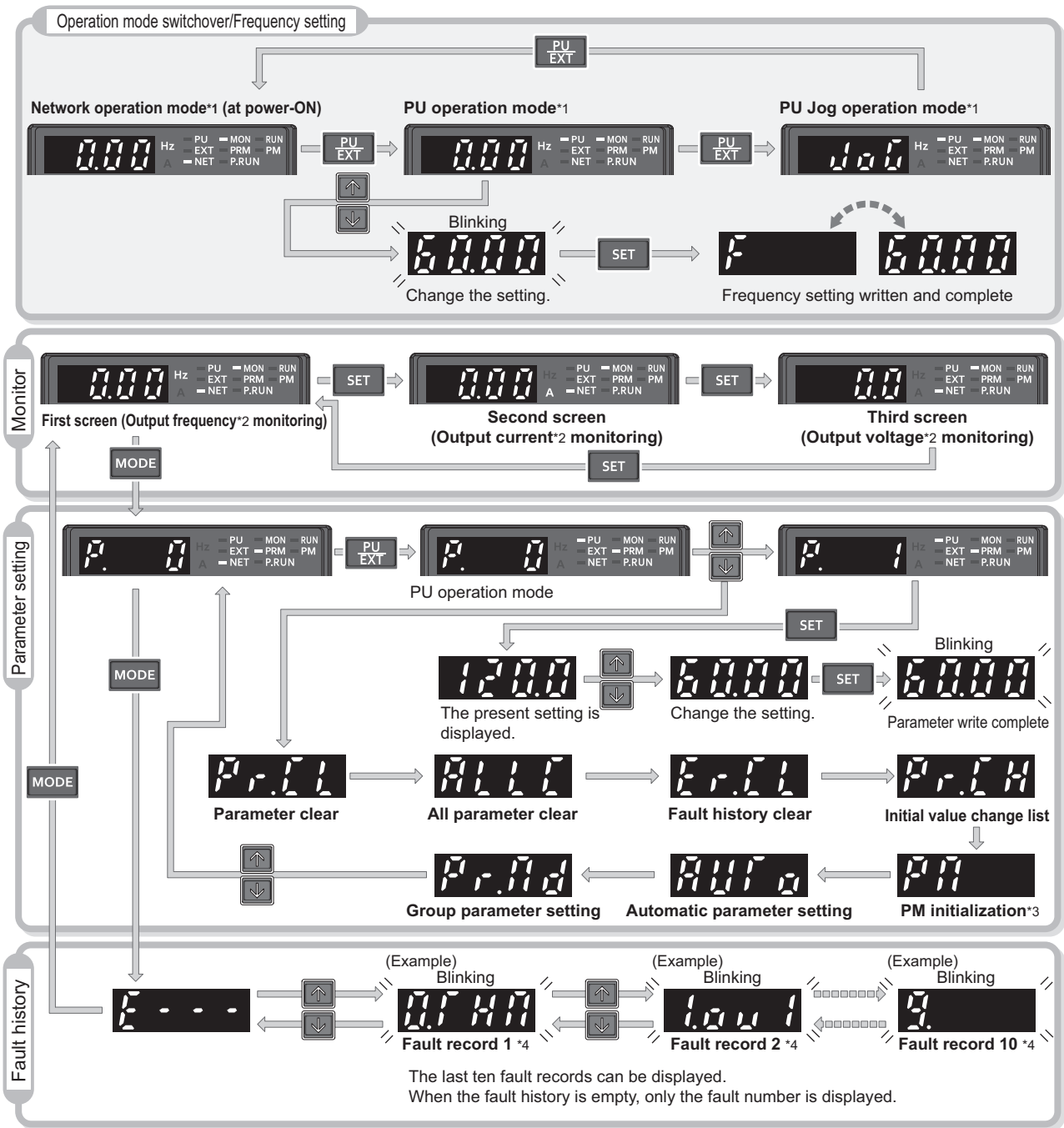

*1 For the details of operation modes, refer to the Instruction Manual (Function).
 *2 The monitor item can be changed. (Refer to the Instruction Manual (Function).)
 *3 Not displayed for the 575 V class.
 *4 For the details of the fault history, refer to the Instruction Manual (Maintenance).

Operation Steps

— : Initial setting

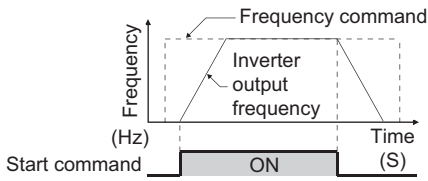

1

Operation Panel, Operation Steps

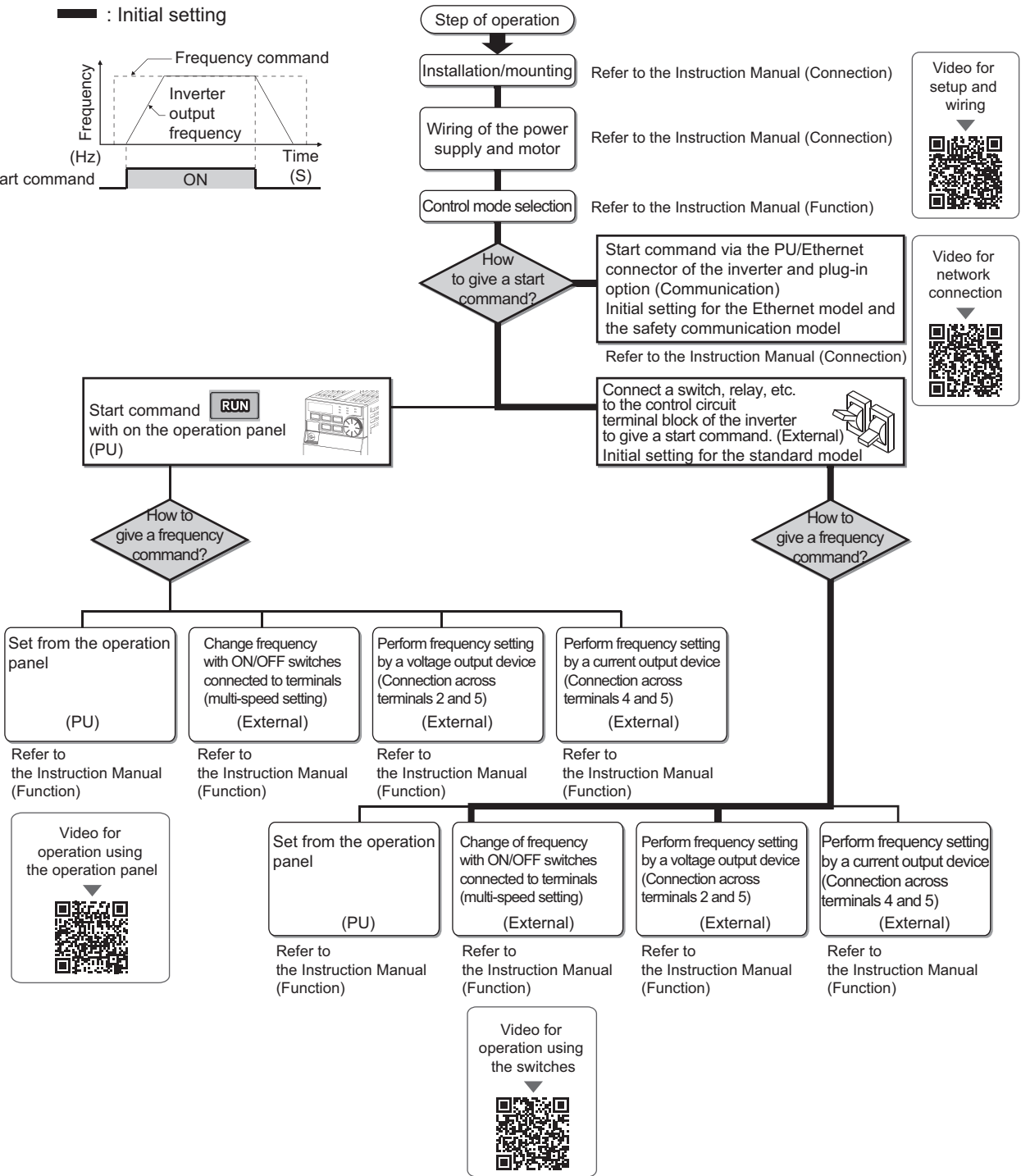

For more information on the product



Parameter list

For simple variable-speed operation of the inverter, the initial values of the parameters may be used as they are. Set the necessary parameters to meet the load and operational specifications. Parameter's setting, change and check can be made on the operation panel.

NOTE

- **Simple** indicates simple mode parameters. Use **Pr.160 User group read selection** to indicate the simple mode parameters only (initial setting is to indicate the extended mode parameters).
- The changing of the parameter settings may be restricted in some operating statuses. Use **Pr.77 Parameter write selection** to change the setting of the restriction.
- Refer to for instruction codes for communication and availability of Parameter clear, all clear, and Parameter copy.

◆ Notation

- [E800]: Available for the standard model.
- [E800-1]: Available for the FM type inverter (standard model).
- [E800-4]: Available for the AM (50 Hz) type inverter (standard model).
- [E800-5]: Available for the AM (60 Hz) type inverter (standard model).
- [E800(-E)]: Available for the standard and Ethernet models.
- [E800-(SC)E]: Available for the Ethernet model and the safety communication model.
- [E800-SCE]: Available for the safety communication model.
- [E800-E]: Available for the Ethernet model.
- [E800-(SC)EPA]: Available for the Protocol group A (Ethernet model / safety communication model).
- [E800-(SC)EPB]: Available for the Protocol group B (Ethernet model / safety communication model).
- [E800-EPC]: Available for the Protocol group C (Ethernet model).
- [100/200/400 V class]: Available for the 100/200/400 V class.
- [575 V class]: Available for the 575 V class inverters.
- [3-phase]: Available for the three-phase power input model.

◆ Parameter initial value groups

- Initial values of parameters of the FR-E800 differ depending on the parameter initial value group. In this Instruction Manual, Gr.1 indicates the parameter initial value group 1, and Gr.2 indicates the parameter initial value group 2.
- FR-E800 inverters are divided into two groups as shown in the following table.

Parameter initial value groups	Model	Specification
Group 1 (Gr.1)	FR-E800-1	RS-485 communication, terminal FM
	FR-E800-5	RS-485 communication, terminal AM
	FR-E800-(SC)EPA	Ethernet communication (Protocol group A)
Group 2 (Gr.2)	FR-E800-4	RS-485 communication, terminal AM
	FR-E800-(SC)EPB	Ethernet communication (Protocol group B)
	FR-E800-EPC	Ethernet communication (Protocol group C)

◆ Pr.0 to Pr.99

Function	Pr.	Pr. group	Name	Setting range	Minimum setting increments	Initial value		Customer setting
						Gr.1	Gr.2	
Basic function	0	G000	Torque boost Simple	0% to 30%	0.1%	6%*1		
						5%*1		
						4%*1		
						3%*1		
						2%*1		
	1	H400	Maximum frequency Simple	0 to 120 Hz	0.01 Hz	120 Hz		
	2	H401	Minimum frequency Simple	0 to 120 Hz	0.01 Hz	0 Hz		
	3	G001	Base frequency Simple	0 to 590 Hz	0.01 Hz	60 Hz	50 Hz	
	4	D301	Multi-speed setting (high speed) Simple	0 to 590 Hz	0.01 Hz	60 Hz	50 Hz	
	5	D302	Multi-speed setting (middle speed) Simple	0 to 590 Hz	0.01 Hz	30 Hz		
6	D303	Multi-speed setting (low speed) Simple	0 to 590 Hz	0.01 Hz	10 Hz			
7*4	F010	Acceleration time Simple	0 to 3600 s	0.1 s	5 s*2			
					10 s*2			
					15 s*2			
8*4	F011	Deceleration time Simple	0 to 3600 s	0.1 s	5 s*2			
					10 s*2			
					15 s*2			
9	H000 C103	Electronic thermal O/L relay Simple Rated motor current Simple	0 to 500 A	0.01 A	Inverter rated current			
DC injection brake	10	G100	DC injection brake operation frequency	0 to 120 Hz	0.01 Hz	3 Hz		
	11	G101	DC injection brake operation time	0 to 10 s, 8888	0.1 s	0.5 s		
	12	G110	DC injection brake operation voltage	0% to 30%	0.1%	6%*3		
						4%*3		
					2%*3			
					1%*3			
—	13	F102	Starting frequency	0 to 60 Hz	0.01 Hz	0.5 Hz		
—	14	G003	Load pattern selection	0 to 3	1	0		

Function	Pr.	Pr. group	Name	Setting range	Minimum setting increments	Initial value		Customer setting
						Gr.1	Gr.2	
JOG operation	15	D200	Jog frequency	0 to 590 Hz	0.01 Hz	5 Hz		
	16*4	F002	Jog acceleration/deceleration time	0 to 3600 s	0.1 s	0.5 s		
—	17	T720	MRS/X10 terminal input selection	0 to 5	1	0		
—	18	H402	High speed maximum frequency	0 to 590 Hz	0.01 Hz	120 Hz		
—	19	G002	Base frequency voltage	0 to 1000 V, 8888, 9999	0.1 V	9999	8888	
Acceleration/deceleration time	20	F000	Acceleration/deceleration reference frequency	1 to 590 Hz	0.01 Hz	60 Hz	50 Hz	
	21	F001	Acceleration/deceleration time increments	0, 1	1	0		
Stall prevention	22	H500	Stall prevention operation level (Torque limit level)	0% to 400%	0.1%	150%		
	23	H610	Stall prevention operation level compensation factor at double speed	0% to 200%, 9999	0.1%	9999		
Multi-speed setting	24 to 27	D304 to D307	Multi-speed setting (speed 4 to speed 7)	0 to 590 Hz, 9999	0.01 Hz	9999		
—	29	F100	Acceleration/deceleration pattern selection	0 to 2	1	0		
—	30	E300	Regenerative function selection	[E800(-E)] 0 to 2 [E800-SCE] 0, 1	1	0		
Frequency jump	31	H420	Frequency jump 1A	0 to 590 Hz, 9999	0.01 Hz	9999		
	32	H421	Frequency jump 1B	0 to 590 Hz, 9999	0.01 Hz	9999		
	33	H422	Frequency jump 2A	0 to 590 Hz, 9999	0.01 Hz	9999		
	34	H423	Frequency jump 2B	0 to 590 Hz, 9999	0.01 Hz	9999		
	35	H424	Frequency jump 3A	0 to 590 Hz, 9999	0.01 Hz	9999		
	36	H425	Frequency jump 3B	0 to 590 Hz, 9999	0.01 Hz	9999		
—	37*4	M000	Speed display	0.01 to 9998	0.001	1800		
Frequency detection	40	E202	RUN key rotation direction selection	0, 1	1	0		
	41	M441	Up-to-frequency sensitivity	0% to 100%	0.1%	10%		
	42	M442	Output frequency detection	0 to 590 Hz	0.01 Hz	6 Hz		
Second function	43	M443	Output frequency detection for reverse rotation	0 to 590 Hz, 9999	0.01 Hz	9999		
	44*4	F020	Second acceleration/deceleration time	0 to 3600 s	0.1 s	5 s*2	10 s*2	15 s*2
	45*4	F021	Second deceleration time	0 to 3600 s, 9999	0.1 s	9999		
	46	G010	Second torque boost	0% to 30%, 9999	0.1%	9999		
	47	G011	Second V/F (base frequency)	0 to 590 Hz, 9999	0.01 Hz	9999		
	48	H600	Second stall prevention operation level	0% to 400%, 9999	0.1%	9999		
	51	H010 C203	Second electronic thermal O/L relay Rated second motor current	0 to 500 A, 9999	0.01 A	9999		

Function	Pr.	Pr. group	Name	Setting range	Minimum setting increments	Initial value		Customer setting
						Gr.1	Gr.2	
Monitoring	52	M100	Operation panel main monitor selection	[E800] 0, 5 to 14, 17 to 20, 22 to 33, 35, 38, 40 to 42, 44, 45, 50 to 57, 61, 62, 64, 65, 67, 68, 71, 72, 81 to 84, 85 [E800-1], 86 [E800-4][E800-5], 91, 97, 100 [E800-(SC)E] 0, 5 to 14, 17 to 20, 22 to 33, 35, 38, 40 to 42, 44, 45, 50 to 57, 61, 62, 64, 65, 67, 68 [E800-E], 71, 72, 83 [E800-(SC)EPA], 91, 97, 100	1	0		
	53	M003	Frequency / rotation speed unit switchover	0, 1, 4	1	0		
	54	M300	FM terminal function selection [E800-1]	1 to 3, 5 to 14, 17, 18, 21, 24, 32, 33, 50, 52, 53, 61, 62, 65, 67, 70, 85, 97	1	1		
	55*7	M040	Frequency monitoring reference	0 to 590 Hz	0.01 Hz	60 Hz	50 Hz	
	56*7	M041	Current monitoring reference	0 to 500 A	0.01 A	Inverter rated current		
Automatic restart	57	A702	Restart coasting time	0, 0.1 to 30 s, 9999	0.1 s	9999		
	58	A703	Restart cushion time	0 to 60 s	0.1 s	1 s		
—	59	F101	Remote function selection	0 to 3, 11 to 13	1	0		
—	60	G030	Energy saving control selection	0, 9	1	0		
Automatic acceleration/deceleration	61	F510	Reference current	0 to 500 A, 9999	0.01 A	9999		
	62	F511	Reference value at acceleration	0% to 400%, 9999	1%	9999		
	63	F512	Reference value at deceleration	0% to 400%, 9999	1%	9999		
—	65	H300	Retry selection	0 to 5	1	0		
—	66	H611	Stall prevention operation reduction starting frequency	0 to 590 Hz	0.01 Hz	60 Hz	50 Hz	
Retry	67	H301	Number of retries at fault occurrence	0 to 10, 101 to 110	1	0		
	68	H302	Retry waiting time	0.1 to 600 s	0.1 s	1 s		
	69	H303	Retry count display erase	0	1	0		
—	70	G107	Special regenerative brake duty	0% to 100%	0.1%	0%		
—	71	C100	Applied motor	[100/200/400 V class] 0, 3, 5, 6, 10, 13, 15, 16, 20, 23, 30, 33, 40, 43, 50, 53, 70, 73, 540, 1140, 1800, 1803, 8090, 8093, 9090, 9093 [575 V class] 0, 3, 5, 6, 10, 13, 15, 16, 30, 33, 8090, 8093, 9090, 9093	1	0		
—	72	E600	PWM frequency selection	0 to 15	1	1		
—	73	T000	Analog input selection	0, 1, 6, 10, 11, 16	1	1		
—	74	T002	Input filter time constant	0 to 8	1	1		
—	75	—	Reset selection/disconnected PU detection/PU stop selection	[E800(-E)] 0 to 3, 14 to 17 [E800-SCE] 0 to 3, 14 to 17, 10000 to 10003, 10014 to 10017	1	[E800(-E)] 14 [E800-SCE] 10014		
		E100	Reset selection	0, 1		0		
		E101	Disconnected PU detection [E800]			1		
		E102	PU stop selection			[E800(-E)] 0 [E800-SCE] 10		
—	E107	Reset limit [E800-SCE]	0, 10 [E800-SCE]					
—	77	E400	Parameter write selection	0 to 2	1	0		
—	78	D020	Reverse rotation prevention selection	0 to 2	1	0		
—	79	D000	Operation mode selection Simple	0 to 4, 6, 7	1	0		

Function	Pr.	Pr. group	Name	Setting range	Minimum setting increments	Initial value		Customer setting
						Gr.1	Gr.2	
Motor constant	80	C101	Motor capacity	0.1 to 30 kW, 9999	0.01 kW	9999		
	81	C102	Number of motor poles	2, 4, 6, 8, 10, 12, 9999	1	9999		
	82	C125	Motor excitation current	0 to 500 A, 9999	0.01 A	9999		
	83	C104	Rated motor voltage	0 to 1000 V	0.1 V	[100/200 V class] 200 V [400 V class] 400 V [575 V class] 575 V		
	84	C105	Rated motor frequency	10 to 400 Hz, 9999	0.01 Hz	9999		
	89	G932	Speed control gain (Advanced magnetic flux vector)	0% to 200%, 9999	0.1%	9999		
	90	C120	Motor constant (R1)	0 to 50 Ω, 9999	0.001 Ω	9999		
	91	C121	Motor constant (R2)	0 to 50 Ω, 9999	0.001 Ω	9999		
	92	C122	Motor constant (L1)/d-axis inductance (Ld)	0 to 6000 mH, 9999	0.1 mH	9999		
	93	C123	Motor constant (L2)/q-axis inductance (Lq)	0 to 6000 mH, 9999	0.1 mH	9999		
	94	C124	Motor constant (X)	0% to 100%, 9999	0.1%	9999		
	95	C111	Online auto tuning selection	0, 1	1	0		
	96	C110	Auto tuning setting/status	0, 1, 11, 301	1	0		

◆ Pr.100 to Pr.199

Function	Pr.	Pr. group	Name	Setting range	Minimum setting increments	Initial value		Customer setting
						Gr.1	Gr.2	
PU connector communication	117	N020	PU communication station number [E800]	0 to 31	1	0		
	118	N021	PU communication speed [E800]	48, 96, 192, 384, 576, 768, 1152	1	192		
	119	—	PU communication stop bit length / data length [E800]	0, 1, 10, 11	1	1		
		N022	PU communication data length [E800]	0, 1		0		
		N023	PU communication stop bit length [E800]	0, 1		1		
	120	N024	PU communication parity check [E800]	0 to 2	1	2		
	121	N025	PU communication retry count [E800]	0 to 10, 9999	1	1		
	122	N026	PU communication check time interval [E800]	0, 0.1 to 999.8 s, 9999	0.1 s	0		
	123	N027	PU communication waiting time setting [E800]	0 to 150 ms, 9999	1 ms	9999		
	124	N028	PU communication CR/LF selection [E800]	0 to 2	1	1		
—	125	T022	Terminal 2 frequency setting gain frequency Simple	0 to 590 Hz	0.01 Hz	60 Hz	50 Hz	
—	126	T042	Terminal 4 frequency setting gain frequency Simple	0 to 590 Hz	0.01 Hz	60 Hz	50 Hz	
PID operation	127	A612	PID control automatic switchover frequency	0 to 590 Hz, 9999	0.01 Hz	9999		
	128	A610	PID action selection	0, 20, 21, 40 to 43, 50, 51, 60, 61, 1000, 1001, 1010, 1011, 2000, 2001, 2010, 2011	1	0		
	129	A613	PID proportional band	0.1% to 1000%, 9999	0.1%	100%		
	130	A614	PID integral time	0.1 to 3600 s, 9999	0.1 s	1 s		
	131	A601	PID upper limit	0% to 100%, 9999	0.1%	9999		
	132	A602	PID lower limit	0% to 100%, 9999	0.1%	9999		
	133	A611	PID action set point	0% to 100%, 9999	0.01%	9999		
134	A615	PID differential time	0.01 to 10 s, 9999	0.01 s	9999			
—	136	A001	MC switchover interlock time [E800(-E)]	0 to 100 s	0.1 s	1 s		
—	139	A004	Automatic switchover frequency from inverter to bypass operation [E800(-E)]	0 to 60 Hz, 9999	0.01 Hz	9999		
PU	145	E103	PU display language selection [E800]	0 to 7	1	—		
—	147	F022	Acceleration/deceleration time switching frequency	0 to 590 Hz, 9999	0.01 Hz	9999		
Current detection	150	M460	Output current detection level	0% to 400%	0.1%	150%		
	151	M461	Output current detection signal delay time	0 to 10 s	0.1 s	0 s		
	152	M462	Zero current detection level	0% to 400%	0.1%	5%		
	153	M463	Zero current detection time	0 to 10 s	0.01 s	0.5 s		
—	154	H631	Voltage reduction selection during stall prevention operation	1, 11	1	1		
—	156	H501	Stall prevention operation selection	0 to 31, 100, 101	1	0		

Function	Pr.	Pr. group	Name	Setting range	Minimum setting increments	Initial value		Customer setting						
						Gr.1	Gr.2							
—	157	M430	OL signal output timer	0 to 25 s, 9999	0.1 s	0 s								
—	158	M301	AM terminal function selection [E800-4][E800-5]	1 to 3, 5 to 14, 17, 18, 21, 24, 32, 33, 50, 52 to 54, 61, 62, 65, 67, 70, 86, 91, 97	1	1								
—	160	E440	User group read selection Simple	0, 1, 9999	1	0								
—	161	E200	Frequency setting/key lock operation selection	0, 1, 10, 11	1	0								
Automatic restart	162	A700	Automatic restart after instantaneous power failure selection	0, 1, 10, 11	1	0								
	165	A710	Stall prevention operation level for restart	0% to 400%	0.1%	150%								
Current detection	166	M433	Output current detection signal retention time	0 to 10 s, 9999	0.1 s	0.1 s								
	167	M464	Output current detection operation selection	0, 1, 10, 11	1	0								
—	168	E000 E080	Parameter for manufacturer setting. Do not set.											
—	169	E001 E081												
Cumulative monitor	170	M020							Watt-hour meter clear	0, 10, 9999	1	9999		
	171	M030							Operation hour meter clear	0, 9999	1	9999		
User group	172	E441	User group registered display/batch clear	9999, (0 to 16)	1	0								
	173	E442	User group registration	0 to 1999, 9999	1	9999								
	174	E443	User group clear	0 to 1999, 9999	1	9999								
Input terminal function assignment	178	T700	STF/DI0 terminal function selection [E800(-E)]	0 to 5, 7, 8, 10, 12 to 16, 18, 22 to 27, 30, 37, 42, 43, 46, 47, 50 to 52, 54, 60, 62, 65 to 67, 72, 74, 76, 84, 87 to 89, 92, 9999	1	60								
	179	T701	STR/DI1 terminal function selection [E800(-E)]	0 to 5, 7, 8, 10, 12 to 16, 18, 22 to 27, 30, 37, 42, 43, 46, 47, 50 to 52, 54, 61, 62, 65 to 67, 72, 74, 76, 84, 87 to 89, 92, 9999	1	61								
	180	T702	RL terminal function selection		1	0								
	181	T703	RM terminal function selection	[E800] 0 to 5, 7, 8, 10, 12 to 16, 18, 22 to 27, 30, 37, 42, 43, 46, 47, 50 to 52, 54, 62, 65 to 67, 72, 74, 76, 84, 87 to 89, 92, 9999	1	1								
	182	T704	RH terminal function selection	[E800-(SC)E]	1	2								
	183	T709	MRS terminal function selection	0 to 4, 8, 13 to 15, 18, 22 to 24, 26, 27, 30, 37, 42, 43, 46, 47, 50 to 52, 54, 72, 74, 76, 84 [E800(-E)], 87 to 89, 92, 9999	1	24								
	184	T711	RES terminal function selection		1	[E800] 62 [E800-(SC)E] 9999								
	185	T751	NET X1 input selection		1	9999								
	186	T752	NET X2 input selection		1									
	187	T753	NET X3 input selection		1									
	188	T754	NET X4 input selection		1									
189	T755	NET X5 input selection		1										

Function	Pr.	Pr. group	Name	Setting range	Minimum setting increments	Initial value		Customer setting
						Gr.1	Gr.2	
Output terminal function assignment	190	M400	RUN terminal function selection	0, 1, 3, 4, 7, 8, 11 to 16, 18 [E800(-E)], 19 [E800(-E)], 20, 24 to 28, 30 to 36, 38 to 41, 44 to 48, 56, 57, 60 to 64, 65 [E800(-E)], 66 [E800(-E)], 68, 70, 80, 81, 82 [E800], 84, 90 to 93, 95, 96, 98 to 101, 103, 104, 107, 108, 111 to 116, 120, 124 to 128, 130 to 136, 138 to 141, 144 to 148, 156, 157, 160 to 164, 165 [E800(-E)], 166 [E800(-E)], 168, 170, 180, 181, 182 [E800], 184, 190 to 193, 195, 196, 198, 199, 206, 211 to 213, 242 [E800-(SC)E], 306, 311 to 313, 342 [E800-(SC)E], 9999	1	0		
	191	M404	FU terminal function selection		1	4		
Output terminal function assignment	192	M405	ABC terminal function selection	[E800] 0, 1, 3, 4, 7, 8, 11 to 16, 18 to 20, 24 to 28, 30 to 36, 38 to 41, 44 to 48, 56, 57, 60 to 66, 68, 70, 80 to 82, 84, 90, 91, 95, 96, 98 to 101, 103, 104, 107, 108, 111 to 116, 120, 124 to 128, 130 to 136, 138 to 141, 144 to 148, 156, 157, 160 to 166, 168, 170, 180 to 182, 184, 190, 191, 195, 196, 198, 199, 206, 211 to 213, 306, 311 to 313, 9999 [E800-(SC)E] 0, 1, 3, 4, 7, 8, 11 to 16, 18 [E800-E], 19 [E800-E], 20, 24 to 28, 30 to 36, 38 to 41, 44 to 48, 56, 57, 60 to 64, 65 [E800-E], 66 [E800-E], 68, 70, 80, 81, 82 [E800-(SC)EPA], 84, 90, 91, 95, 96, 98 to 101, 103, 104, 107, 108, 111 to 116, 120, 124 to 128, 130 to 136, 138 to 141, 144 to 148, 156, 157, 160 to 164, 165 [E800-E], 166 [E800-E], 168, 170, 180, 181, 182 [E800-(SC)EPA], 184, 190, 191, 195, 196, 198, 199, 206, 211 to 213, 242, 306, 311 to 313, 342, 9999	1	99		

Function	Pr.	Pr. group	Name	Setting range	Minimum setting increments	Initial value		Customer setting
						Gr.1	Gr.2	
Output terminal function assignment	193	M451	NET Y1 output selection		1		9999	
	194	M452	NET Y2 output selection	0, 1, 3, 4, 7, 8, 11 to 16, 18 [E800(-E)], 19 [E800(-E)], 20, 24 to 28, 30 to 36, 38 to 41, 44 to 48, 56, 57, 60 to 64, 65 [E800(-E)], 66 [E800(-E)], 68, 70, 80, 81, 84, 90 to 93, 95, 98 to 101, 103, 104, 107, 108, 111 to 116, 120, 124 to 128, 130 to 136, 138 to 141, 144 to 148, 156, 157, 160 to 164, 165 [E800(-E)], 166 [E800(-E)], 168, 170, 180, 181, 184, 190 to 193, 195, 198, 199, 206, 211 to 213, 242 [E800-(SC)E], 306, 311 to 313, 342 [E800-(SC)E], 9999	1		9999	
	195	M453	NET Y3 output selection		1		9999	
	196	M454	NET Y4 output selection		1		9999	
	197	M406	Parameter for manufacturer setting. Do not set.					
—	198	E709	Display corrosion level	(1 to 3)	1	1		

◆ Pr.200 to Pr.299

Function	Pr.	Pr. group	Name	Setting range	Minimum setting increments	Initial value		Customer setting	
						Gr.1	Gr.2		
Multi-speed setting	232 to 239	D308 to D315	Multi-speed setting (speed 8 to speed 15)	0 to 590 Hz, 9999	0.01 Hz	9999			
	240	E601	Soft-PWM operation selection	0, 1	1	1			
	241	M043	Analog input display unit switchover	0, 1	1	0			
—	244	H100	Cooling fan operation selection	0, 1	1	1			
Slip compensation	245	G203	Rated slip	0% to 50%, 9999	0.01%	9999			
	246	G204	Slip compensation time constant	0.01 to 10 s	0.01 s	0.5 s			
	247	G205	Constant output range slip compensation selection	0, 9999	1	9999			
	249	H101	Earth (ground) fault detection at start	0, 1	1	0	1		
—	250	G106	Stop selection	0 to 100 s, 1000 to 1100 s, 8888, 9999	0.1 s	9999			
—	251	H200	Output phase loss protection selection	0, 1	1	1			
Life check	255	E700	Life alarm status display	(0 to 879)	1	0			
	256	E701	Inrush current limit circuit life display	(0% to 100%)	1%	100%			
	257	E702	Control circuit capacitor life display	(0% to 100%)	1%	100%			
	258	E703	Main circuit capacitor life display	(0% to 100%)	1%	100%			
—	259	E704	Main circuit capacitor life measuring	0, 1	1	0			
—	260	E602	PWM frequency automatic switchover	0, 10	1	10			
Power failure stop	261	A730	Power failure stop selection	0 to 2	1	0			
	267	T001	Terminal 4 input selection	0 to 2	1	0			
	268	M022	Monitor decimal digits selection	0, 1, 9999	1	9999			
—	269	E023	Parameter for manufacturer setting. Do not set.						
Stop-on-contact control	270	A200	Stop-on-contact control selection	0, 1, 11	1	0			
	275	A205	Stop-on contact excitation current low-speed scaling factor	0% to 300%, 9999	0.1%	9999			
	276	A206	PWM carrier frequency at stop-on contact	0 to 9, 9999	1	9999			
	277	H630	Stall prevention operation current switchover	0, 1	1	0			
Brake sequence	278	A100	Brake opening frequency	0 to 30 Hz	0.01 Hz	3 Hz			
	279	A101	Brake opening current	0% to 400%	0.1%	130%			
	280	A102	Brake opening current detection time	0 to 2 s	0.1 s	0.3 s			
	281	A103	Brake operation time at start	0 to 5 s	0.1 s	0.3 s			
	282	A104	Brake operation frequency	0 to 30 Hz	0.01 Hz	6 Hz			
	283	A105	Brake operation time at stop	0 to 5 s	0.1 s	0.3 s			
	284	A106	Deceleration detection function selection	0, 1	1	0			
—	285	A107	Overspeed detection frequency	0 to 30 Hz, 9999	0.01 Hz	9999			
		H416	Speed deviation excess detection frequency						
Droop control	286	G400	Droop gain	0% to 100%	0.1%	0%			
	287	G401	Droop filter time constant	0 to 1 s	0.01 s	0.3 s			
—	289	M431	Inverter output terminal filter	5 to 50 ms, 9999	1 ms	9999			
—	290	M044	Monitor negative output selection	0, 1, 4, 5, 8, 9, 12, 13	1	0			
—	292	A110 F500	Automatic acceleration/deceleration	0, 1, 7, 8, 11	1	0			
—	293	F513	Acceleration/deceleration separate selection	0 to 2	1	0			
—	295	E201	Frequency change increment amount setting [E800]	0, 0.01, 0.1, 1, 10,	0.01	0			

Function	Pr.	Pr. group	Name	Setting range	Minimum setting increments	Initial value		Customer setting
						Gr.1	Gr.2	
Password	296	E410	Password lock level	0 to 6, 99, 100 to 106, 199, 9999	1	9999		
	297	E411	Password lock/unlock	(0 to 5), 1000 to 9998, 9999	1	9999		
—	298	A711	Frequency search gain	0 to 32767, 9999	1	9999		
—	299	A701	Rotation direction detection selection at restarting	0, 1, 9999	1	0		

◆ Pr.300 to Pr.399

Function	Pr.	Pr. group	Name	Setting range	Minimum setting increments	Initial value		Customer setting
						Gr.1	Gr.2	
CC-Link IE	313*8	M410	DO0 output selection	0, 1, 3, 4, 7, 8, 11 to 16, 18 [E800(-E)], 19 [E800(-E)], 20, 24 to 28, 30 to 36, 38 to 41, 44 to 48, 56, 57, 60 to 64, 65 [E800(-E)], 66 [E800(-E)], 68, 70, 80, 81, 84, 90 to 93, 95, 96, 98 to 101, 103, 104, 107, 108, 111 to 116, 120, 124 to 128, 130 to 136, 138 to 141, 144 to 148, 156, 157, 160 to 164, 165 [E800(-E)], 166 [E800(-E)], 168, 170, 180, 181, 184, 190 to 193, 195, 196, 198, 199, 206, 211 to 213, 242 [E800(-SC)E], 306, 311 to 313, 342 [E800(-SC)E], 9999	1	9999		
	314*8	M411	DO1 output selection		1	9999		
	315*8	M412	DO2 output selection		1	9999		
	316*8	M413	DO3 output selection		1	9999		
	317*8	M414	DO4 output selection		1	9999		
	318*8	M415	DO5 output selection		1	9999		
	319*8	M416	DO6 output selection		1	9999		
	320*8	M420	RA1 output selection		1	0		
	321*8	M421	RA2 output selection		1	1		
	322*8	M422	RA3 output selection		1	4		
RS-485 communication	338	D010	Communication operation command source	0, 1	1	0		
	339	D011	Communication speed command source	0 to 2	1	0		
	340	D001	Communication startup mode selection	0, 1, 10	1	[E800] 0 [E800(-SC)E] 10		
	342	N001	Communication EEPROM write selection	0, 1	1	0		
	343	N080	Communication error count [E800]	(0 to 999)	1	0		
	—	349*9	N010	Communication reset selection	0, 1	1	0	

Function	Pr.	Pr. group	Name	Setting range	Minimum setting increments	Initial value		Customer setting
						Gr.1	Gr.2	
Orientation control	350*5	A510	Stop position command selection	0, 9999	1	9999		
	351*5	A526	Orientation speed	0 to 30 Hz	0.01 Hz	2 Hz		
	352*5	A527	Creep speed	0 to 10 Hz	0.01 Hz	0.5 Hz		
	353*5	A528	Creep switchover position	0 to 16383	1	511		
	354*5	A529	Position loop switchover position	0 to 8191	1	96		
	355*5	A530	DC injection brake start position	0 to 255	1	5		
	356*5	A531	Internal stop position command	0 to 16383	1	0		
	357*5	A532	Orientation in-position zone	0 to 255	1	5		
	358*5	A533	Servo torque selection	0 to 13	1	1		
	359*5	C141	Encoder rotation direction	100, 101	1	101		
	361*5	A512	Position shift	0 to 16383	1	0		
	362*5	A520	Orientation position loop gain	0.1 to 100	0.1	1.0		
	363*5	A521	Completion signal output delay time	0 to 5 s	0.1 s	0.5 s		
	364*5	A522	Encoder stop check time	0 to 5 s	0.1 s	0.5 s		
	365*5	A523	Orientation limit	0 to 60 s, 9999	1 s	9999		
	366*5	A524	Recheck time	0 to 5 s, 9999	0.1 s	9999		
Encoder feedback	367*5	G240	Speed feedback range	0 to 590 Hz, 9999	0.01 Hz	9999		
	368*5	G241	Feedback gain	0 to 100	0.1	1		
	369*5	C140	Number of encoder pulses	2 to 4096	1	1024		
	374	H800	Overspeed detection level	0 to 590 Hz, 9999	0.01 Hz	9999		
	375	H801	Faulty acceleration rate detection level	0 to 400 Hz, 9999	0.01 Hz	9999		
	376*5	C148	Encoder signal loss detection enable/disable selection	0, 1	1	0		
—	390	N054	% setting reference frequency [E800][E800-(SC)EPA]	1 to 590 Hz	0.01 Hz	60 Hz	—	
Orientation control	393*5	A525	Orientation selection	0 to 2	1	0		
	396*5	A542	Orientation speed gain (P term)	0 to 1000	1	60		
	397*5	A543	Orientation speed integral time	0 to 20 s	0.001 s	0.333 s		
	398*5	A544	Orientation speed gain (D term)	0 to 100	0.1	1		
	399*5	A545	Orientation deceleration ratio	0 to 1000	1	20		

◆ Pr.400 to Pr.499

Function	Pr.	Pr. group	Name	Setting range	Minimum setting increments	Initial value		Customer setting
						Gr.1	Gr.2	
PLC	414	A800	PLC function operation selection	0 to 2, 11, 12	1	0		
	415	A801	Inverter operation lock mode setting	0, 1	1	0		
Position control	420	B001	Command pulse scaling factor numerator (electronic gear numerator)	1 to 32767	1	1		
	421	B002	Command pulse multiplication denominator (electronic gear denominator)	1 to 32767	1	1		
	422	B003	Position control gain	0 to 150 s ⁻¹	1 s ⁻¹	10 s ⁻¹		
	423	B004	Position feed forward gain	0% to 100%	1%	0%		
	425	B006	Position feed forward command filter	0 to 5 s	0.001 s	0 s		
	426	B007	In-position width	0 to 32767 pulses	1 pulse	100 pulses		
	427	B008	Excessive level error	0 to 400k pulses, 9999	1k pulses	40k pulses		
	430	B011	Pulse monitor selection	0 to 5, 100 to 105, 1000 to 1005, 1100 to 1105, 8888, 9999	1	9999		
Ethernet	442	N620	Default gateway address 1 [E800-(SC)EPA][E800-(SC)EPB]	0 to 255	1	0		
	443	N621	Default gateway address 2 [E800-(SC)EPA][E800-(SC)EPB]					
	444	N622	Default gateway address 3 [E800-(SC)EPA][E800-(SC)EPB]					
	445	N623	Default gateway address 4 [E800-(SC)EPA][E800-(SC)EPB]					
—	446	B012	Model position control gain	0 to 150 s ⁻¹	1 s ⁻¹	25 s ⁻¹		

Function	Pr.	Pr. group	Name	Setting range	Minimum setting increments	Initial value		Customer setting
						Gr.1	Gr.2	
Second motor constant	450	C200	Second applied motor	[100/200/400 V class] 0, 3, 5, 6, 10, 13, 15, 16, 20, 23, 30, 33, 40, 43, 50, 53, 70, 73, 540, 1140, 1800, 1803, 8090, 8093, 9090, 9093, 9999 [575 V class] 0, 3, 5, 6, 10, 13, 15, 16, 30, 33, 8090, 8093, 9090, 9093, 9999	1		9999	
	451	G300	Second motor control method selection	10 to 14, 20, 40, 9999	1		9999	
	453	C201	Second motor capacity	0.1 to 30 kW, 9999	0.01 kW		9999	
	454	C202	Number of second motor poles	2, 4, 6, 8, 10, 12, 9999	1		9999	
	455	C225	Second motor excitation current	0 to 500 A, 9999	0.01 A		9999	
	456	C204	Rated second motor voltage	0 to 1000 V	0.1 V		[100/200 V class] 200 V [400 V class] 400 V [575 V class] 575 V	
	457	C205	Rated second motor frequency	10 to 400 Hz, 9999	0.01 Hz		9999	
	458	C220	Second motor constant (R1)	0 to 50 Ω, 9999	0.001 Ω		9999	
	459	C221	Second motor constant (R2)	0 to 50 Ω, 9999	0.001 Ω		9999	
	460	C222	Second motor constant (L1) / d-axis inductance (Ld)	0 to 6000 mH, 9999	0.1 mH		9999	
	461	C223	Second motor constant (L2) / q-axis inductance (Lq)	0 to 6000 mH, 9999	0.1 mH		9999	
	462	C224	Second motor constant (X)	0% to 100%, 9999	0.1%		9999	
	463	C210	Second motor auto tuning setting/status	0, 1, 11	1		0	
Position control	464	B020	Digital position control sudden stop deceleration time	0.01 to 360 s	0.01 s		0.01 s	
	465	B021	First target position lower 4 digits	0 to 9999	1		0	
	466	B022	First target position upper 4 digits	0 to 9999	1		0	
	467	B023	Second target position lower 4 digits	0 to 9999	1		0	
	468	B024	Second target position upper 4 digits	0 to 9999	1		0	
	469	B025	Third target position lower 4 digits	0 to 9999	1		0	
	470	B026	Third target position upper 4 digits	0 to 9999	1		0	
	471	B027	Fourth target position lower 4 digits	0 to 9999	1		0	
	472	B028	Fourth target position upper 4 digits	0 to 9999	1		0	
	473	B029	Fifth target position lower 4 digits	0 to 9999	1		0	
	474	B030	Fifth target position upper 4 digits	0 to 9999	1		0	
	475	B031	Sixth target position lower 4 digits	0 to 9999	1		0	
	476	B032	Sixth target position upper 4 digits	0 to 9999	1		0	
477	B033	Seventh target position lower 4 digits	0 to 9999	1		0		
478	B034	Seventh target position upper 4 digits	0 to 9999	1		0		
Remote output	495	M500	Remote output selection	0, 1, 10, 11	1		0	
	496	M501	Remote output data 1	0 to 4095	1		0	
	497	M502	Remote output data 2	0 to 4095	1		0	
—	498	A804	PLC function flash memory clear	0, 9696 (0 to 9999)	1		0	

◆ Pr.500 to Pr.599

Function	Pr.	Pr. group	Name	Setting range	Minimum setting increments	Initial value		Customer setting
						Gr.1	Gr.2	
—	502	N013	Stop mode selection at communication error	0 to 2, 6	1		0	
Maintenance	503	E710	Maintenance timer	0 (1 to 9998)	1		0	
	504	E711	Maintenance timer warning output set time	0 to 9998, 9999	1		9999	
—	505	M001	Speed setting reference	1 to 590 Hz	0.01 Hz		60 Hz	50 Hz
Life check	506	E705	Display estimated main circuit capacitor residual life	(0% to 100%)	1%		100%	
	507	E706	Display/reset ABC relay contact life	0% to 100%	1%		100%	
	509	E708	Display power cycle life	(0% to 100%)	0.01%		100%	
Position control	510	B196	Rough match output range	0 to 32767	1		0	
	511	B197	Home position return shifting speed	0 to 400 Hz	0.01 Hz		0.5 Hz	

Function	Pr.	Pr. group	Name	Setting range	Minimum setting increments	Initial value		Customer setting
						Gr.1	Gr.2	
Emergency drive	514	H324	Emergency drive dedicated retry waiting time [E800(-E)]	0.1 to 600 s, 9999	0.1 s	9999		
	515	H322	Emergency drive dedicated retry count [E800(-E)]	1 to 200, 9999	1	1		
	523	H320	Emergency drive mode selection [E800(-E)]	100, 111, 112, 121, 122, 200, 211, 212, 221, 222, 300, 311, 312, 321, 322, 400, 411, 412, 421, 422, 9999	1	9999		
	524	H321	Emergency drive running speed [E800(-E)]	0 to 590 Hz, 9999	0.01 Hz	9999		
—	538	B015	Current position retention selection	1, 2, 11, 12, 9999	1	9999		
Communication	541*9	N100	Frequency command sign selection	0, 1	1	0		
	544*9	N103	CC-Link extended setting	0, 1, 12, 14, 18, 38, 100, 112, 114, 118, 138	1	0		
USB	547	N040	USB communication station number	0 to 31	1	0		
	548	N041	USB communication check time interval	0 to 999.8 s, 9999	0.1 s	9999		
Communication	549	N000	Protocol selection [E800]	0 to 2	1	0		
	550	D012	NET mode operation command source selection	[E800] 0, 2, 9999 [E800-(SC)E] 0, 5, 9999	1	9999		
	551	D013	PU mode operation command source selection	[E800] 2 to 4, 9999 [E800-(SC)E] 3, 4, 9999	1	9999		
—	552	H429	Frequency jump range	0 to 30 Hz, 9999	0.01 Hz	9999		
PID control	553	A603	PID deviation limit	0% to 100%, 9999	0.1%	9999		
	554	A604	PID signal operation selection	0 to 3, 10 to 13	1	0		
Average current monitoring	555	E720	Current average time	0.1 to 1 s	0.1 s	1 s		
	556	E721	Data output mask time	0 to 20 s	0.1 s	0 s		
	557	E722	Current average value monitor signal output reference current	0 to 500 A	0.01 A	Inverter rated current		
—	560	A712	Second frequency search gain	0 to 32767, 9999	1	9999		
—	561	H020	PTC thermistor protection level	0.5 to 30 kΩ, 9999	0.01 kΩ	9999		
—	563	M021	Energization time carrying-over times	(0 to 65535)	1	0		
—	564	M031	Operating time carrying-over times	(0 to 65535)	1	0		
Second motor constant	569	G942	Second motor speed control gain	0% to 200%, 9999	0.1%	9999		
	570	E301	Multiple rating setting [3-phase]	1, 2	1	2		
—	571	F103	Holding time at a start	0 to 10 s, 9999	0.1 s	9999		
—	574	C211	Second motor online auto tuning	0, 1	1	0		
PID control	575	A621	Output interruption detection time	0 to 3600 s, 9999	0.1 s	1 s		
	576	A622	Output interruption detection level	0 to 590 Hz	0.01 Hz	0 Hz		
	577	A623	Output interruption cancel level	900% to 1100%	0.1%	1000%		

Function	Pr.	Pr. group	Name	Setting range	Minimum setting increments	Initial value		Customer setting
						Gr.1	Gr.2	
Traverse	592	A300	Traverse function selection	0 to 2	1	0		
	593	A301	Maximum amplitude amount	0% to 25%	0.1%	10%		
	594	A302	Amplitude compensation amount during deceleration	0% to 50%	0.1%	10%		
	595	A303	Amplitude compensation amount during acceleration	0% to 50%	0.1%	10%		
	596	A304	Amplitude acceleration time	0.1 to 3600 s	0.1 s	5 s		
	597	A305	Amplitude deceleration time	0.1 to 3600 s	0.1 s	5 s		

◆ Pr.600 to Pr.699

Function	Pr.	Pr. group	Name	Setting range	Minimum setting increments	Initial value		Customer setting
						Gr.1	Gr.2	
Electronic thermal O/L relay	600	H001	First free thermal reduction frequency 1	0 to 590 Hz, 9999	0.01 Hz	9999		
	601	H002	First free thermal reduction ratio 1	1% to 100%	1%	100%		
	602	H003	First free thermal reduction frequency 2	0 to 590 Hz, 9999	0.01 Hz	9999		
	603	H004	First free thermal reduction ratio 2	1% to 100%	1%	100%		
	604	H005	First free thermal reduction frequency 3	0 to 590 Hz, 9999	0.01 Hz	9999		
	607	H006	Motor permissible load level	110% to 250%	1%	150%		
—	608	H016	Second motor permissible load level	110% to 250%, 9999	1%	9999		
PID control	609	A624	PID set point/deviation input selection	2 to 5	1	2		
	610	A625	PID measured value input selection	2 to 5	1	3		
—	611	F003	Acceleration time at a restart	0 to 3600 s, 9999	0.1 s	9999		
—	631	H182	Inverter output fault detection enable/disable selection	0, 1	1	0		
Cumulative pulse monitoring	635*5	M610	Cumulative pulse clear signal selection	0, 1	1	0		
	636*5	M611	Cumulative pulse division scaling factor	1 to 16384	1	1		
	638*5	M613	Cumulative pulse storage	0, 1	1	0		
Brake sequence	639	A108	Brake opening current selection	0, 1	1	0		
	640	A109	Brake operation frequency selection	0, 1	1	0		
Speed smoothing control	653	G410	Speed smoothing control	0% to 200%	0.1%	0%		
	654	G411	Speed smoothing cutoff frequency	0 to 120 Hz	0.01 Hz	20 Hz		
Increased magnetic excitation deceleration	660	G130	Increased magnetic excitation deceleration operation selection	0, 1	1	0		
	661	G131	Magnetic excitation increase rate	0% to 40%, 9999	0.1%	9999		
	662	G132	Increased magnetic excitation current level	0% to 200%	0.1%	100%		
—	665	G125	Regeneration avoidance frequency gain	0% to 200%	0.1%	100%		

Function	Pr.	Pr. group	Name	Setting range	Minimum setting increments	Initial value		Customer setting
						Gr.1	Gr.2	
—	673	G060	SF-PR slip amount adjustment operation selection [100/200/400 V class]	2, 4, 6, 9999	1	9999		
—	674	G061	SF-PR slip amount adjustment gain [100/200/400 V class]	0% to 500%	0.1%	100%		
—	675	A805	User parameter auto storage function selection	1, 9999	1	9999		
—	690	H881	Deceleration check time	0 to 3600 s, 9999	0.1 s	1 s		
Electronic thermal O/L relay	692	H011	Second free thermal reduction frequency 1	0 to 590 Hz, 9999	0.01 Hz	9999		
	693	H012	Second free thermal reduction ratio 1	1% to 100%	1%	100%		
	694	H013	Second free thermal reduction frequency 2	0 to 590 Hz, 9999	0.01 Hz	9999		
	695	H014	Second free thermal reduction ratio 2	1% to 100%	1%	100%		
	696	H015	Second free thermal reduction frequency 3	0 to 590 Hz, 9999	0.01 Hz	9999		
—	698	G219	Speed control D gain	0% to 100%	0.1%	0%		
—	699	T740	Input terminal filter [E800(-E)]	5 to 50 ms, 9999	1 ms	9999		

◆ Pr.700 to Pr.799

Function	Pr.	Pr. group	Name	Setting range	Minimum setting increments	Initial value		Customer setting
						Gr.1	Gr.2	
Motor constant	702	C106	Maximum motor frequency	0 to 400 Hz, 9999	0.01 Hz	9999		
	706	C130	Induced voltage constant (phi f)	0 to 5000 mV (rad/s), 9999	0.1 mV (rad/s)	9999		
	707	C107	Motor inertia (integer)	10 to 999, 9999	1	9999		
	711	C131	Motor Ld decay ratio	0% to 100%, 9999	0.1%	9999		
	712	C132	Motor Lq decay ratio	0% to 100%, 9999	0.1%	9999		
	717	C182	Starting resistance tuning compensation coefficient 1	0% to 200%, 9999	0.1%	9999		
	720	C188	Starting resistance tuning compensation coefficient 2	0% to 200%, 9999	0.1%	9999		
	721	C185	Starting magnetic pole position detection pulse width	0 to 6000 μs, 9999	1 μs	9999		
	724	C108	Motor inertia (exponent)	0 to 7, 9999	1	9999		
	725	C133	Motor protection current level	100% to 500%, 9999	0.1%	9999		
BACnet	726	N050	Auto Baudrate/Max Master [E800]	0 to 255	1	255		
	727	N051	Max Info Frames [E800]	1 to 255	1	1		
	728	N052	Device instance number (Upper 3 digits) [E800][E800-(SC)EPA]	0 to 419	1	0		
	729	N053	Device instance number (Lower 4 digits) [E800][E800-(SC)EPA]	0 to 9999	1	0		
Motor constant	737	C288	Second motor starting resistance tuning compensation coefficient 2	0% to 200%, 9999	0.1%	9999		
	738	C230	Second motor induced voltage constant (phi f)	0 to 5000 mV (rad/s), 9999	0.1 mV (rad/s)	9999		
	739	C231	Second motor Ld decay ratio	0% to 100%, 9999	0.1%	9999		
	740	C232	Second motor Lq decay ratio	0% to 100%, 9999	0.1%	9999		
	741	C282	Second motor starting resistance tuning compensation coefficient 1	0% to 200%, 9999	0.1%	9999		
	742	C285	Second motor magnetic pole detection pulse width	0 to 6000 μs, 9999	1 μs	9999		
	743	C206	Second motor maximum frequency	0 to 400 Hz, 9999	0.01 Hz	9999		
	744	C207	Second motor inertia (integer)	10 to 999, 9999	1	9999		
	745	C208	Second motor inertia (exponent)	0 to 7, 9999	1	9999		
—	746	C233	Second motor protection current level	100% to 500%, 9999	0.1%	9999		
—	759	A600	PID unit selection	0 to 43, 9999	1	9999		

Function	Pr.	Pr. group	Name	Setting range	Minimum setting increments	Initial value		Customer setting
						Gr.1	Gr.2	
Monitoring	774	M101	Operation panel monitor selection 1	[E800] 1 to 3, 5 to 14, 17 to 20, 22 to 33, 35, 38, 40 to 42, 44, 45, 50 to 57, 61, 62, 64, 65, 67, 68, 71, 72, 81 to 84, 85	1	9999		
	775	M102	Operation panel monitor selection 2	[E800-1], 86 [E800-4][E800-5], 91, 97, 100, 9999 [E800-(SC)E] 1 to 3, 5 to 14, 17 to 20, 22 to 33, 35, 38, 40 to 42, 44, 45, 50 to 57, 61, 62, 64, 65, 67, 68 [E800-E], 71, 72, 83	1	9999		
	776	M103	Operation panel monitor selection 3	[E800-(SC)EPA], 91, 97, 100, 9999	1	9999		
—	779	N014	Operation frequency during communication error	0 to 590 Hz, 9999	0.01 Hz	9999		
—	791*4	F070	Acceleration time in low-speed range	0 to 3600 s, 9999	0.1 s	9999		
—	792*4	F071	Deceleration time in low-speed range	0 to 3600 s, 9999	0.1 s	9999		

◆ Pr.800 to Pr.999

Function	Pr.	Pr. group	Name	Setting range	Minimum setting increments	Initial value		Customer setting
						Gr.1	Gr.2	
—	800	G200	Control method selection	0 to 5, 9, 10 to 14, 19, 20, 40	1	40		
—	801	H704	Output limit level	0% to 400%, 9999	0.1%	9999		
—	802	G102	Pre-excitation selection	0, 1	1	0		
Torque command	803	G210	Constant output range torque characteristic selection	0 to 2, 10	1	0		
	804	D400	Torque command source selection	0, 1, 3 to 6	1	0		
	805	D401	Torque command value (RAM)	600% to 1400%	1%	1000%		
	806	D402	Torque command value (RAM, EEPROM)	600% to 1400%	1%	1000%		
Speed limit	807	H410	Speed limit selection	0, 1	1	0		
	808	H411	Speed limit	0 to 400 Hz	0.01 Hz	60 Hz	50 Hz	
	809	H412	Reverse-side speed limit	0 to 400 Hz, 9999	0.01 Hz	9999		
Torque limit	810	H700	Torque limit input method selection	0 to 2	1	0		
	811	D030	Set resolution switchover	0, 10	1	0		
	812	H701	Torque limit level (regeneration)	0% to 400%, 9999	0.1%	9999		
	813	H702	Torque limit level (3rd quadrant)	0% to 400%, 9999	0.1%	9999		
	814	H703	Torque limit level (4th quadrant)	0% to 400%, 9999	0.1%	9999		
	815	H710	Torque limit level 2	0% to 400%, 9999	0.1%	9999		
	816	H720	Torque limit level during acceleration	0% to 400%, 9999	0.1%	9999		
817	H721	Torque limit level during deceleration	0% to 400%, 9999	0.1%	9999			
Adjustment	820	G211	Speed control P gain 1	0% to 1000%	1%	60%		
	821	G212	Speed control integral time 1	0 to 20 s	0.001 s	0.333 s		
	822	T003	Speed setting filter 1	0 to 5 s, 9999	0.001 s	9999		
	823*5	G215	Speed detection filter 1	0 to 0.01 s	0.001 s	0.001 s		
	824	G213	Torque control P gain 1 (current loop proportional gain)	0% to 500%	1%	100%		
	825	G214	Torque control integral time 1 (current loop integral time)	0 to 500 ms	0.1 ms	5 ms		
	826	T004	Torque setting filter 1	0 to 5 s, 9999	0.001 s	9999		
	828	G224	Model speed control gain	0 to 1000 rad/s	1 rad/s	100 rad/s		
	830	G311	Speed control P gain 2	0% to 1000%, 9999	1%	9999		
	831	G312	Speed control integral time 2	0 to 20 s, 9999	0.001 s	9999		
	832	T005	Speed setting filter 2	0 to 5 s, 9999	0.001 s	9999		
	833*5	G315	Speed detection filter 2	0 to 0.01 s, 9999	0.001 s	9999		
	834	G313	Torque control P gain 2 (current loop proportional gain)	0% to 500%, 9999	1%	9999		
835	G314	Torque control integral time 2 (current loop integral time)	0 to 500 ms, 9999	0.1 ms	9999			
836	T006	Torque setting filter 2	0 to 5 s, 9999	0.001 s	9999			

Function	Pr.	Pr. group	Name	Setting range	Minimum setting increments	Initial value		Customer setting
						Gr.1	Gr.2	
Torque bias	840	G230	Torque bias selection	0 to 3, 9999	1	9999		
	841	G231	Torque bias 1	600% to 1400%, 9999	1%	9999		
	842	G232	Torque bias 2	600% to 1400%, 9999	1%	9999		
	843	G233	Torque bias 3	600% to 1400%, 9999	1%	9999		
	844	G234	Torque bias filter	0 to 5 s, 9999	0.001 s	9999		
	845	G235	Torque bias operation time	0 to 5 s, 9999	0.01 s	9999		
	846	G236	Torque bias balance compensation	0% to 100%, 9999	0.1%	9999		
	847	G237	Fall-time torque bias terminal 4 bias	0% to 400%, 9999	1%	9999		
Additional function	848	G238	Fall-time torque bias terminal 4 gain	0% to 400%, 9999	1%	9999		
	849	T007	Analog input offset adjustment	0% to 200%	0.1%	100%		
	850	G103	Brake operation selection	0 to 2	1	0		
	853	H417	Speed deviation time	0 to 100 s	0.1 s	1 s		
	854	G217	Excitation ratio	0% to 100%	1%	100%		
	858	T040	Terminal 4 function assignment	0, 4, 6, 9999	1	0		
	859	C126	Torque current/Rated PM motor current	0 to 500 A, 9999	0.01 A	9999		
	860	C226	Second motor torque current/Rated PM motor current	0 to 500 A, 9999	0.01 A	9999		
Indication	864	M470	Torque detection	0% to 400%	0.1%	150%		
	865	M446	Low speed detection	0 to 590 Hz	0.01 Hz	1.5 Hz		
—	866	M042	Torque monitoring reference	0% to 400%	0.1%	150%		
—	867	M321	AM output filter [E800-4][E800-5]	0 to 5 s	0.01 s	0.01 s		
—	870	M440	Speed detection hysteresis	0 to 15 Hz	0.01 Hz	0 Hz		
Protective function	872	H201	Input phase loss protection selection [3-phase]	0, 1	1	1		
	873*5	H415	Speed limit	0 to 400 Hz	0.01 Hz	20 Hz		
	874	H730	OLT level setting	0% to 400%	0.1%	150%		
Control system	877	G220	Speed feed forward control/model adaptive speed control selection	0 to 2	1	0		
	878	G221	Speed feed forward filter	0.01 to 1 s	0.01 s	0.01 s		
	879	G222	Speed feed forward torque limit	0% to 400%	0.1%	150%		
	880	C114	Load inertia ratio	0 to 200 times	0.1 time	7 times		
	881	G223	Speed feed forward gain	0% to 1000%	1%	0%		
Regeneration avoidance	882	G120	Regeneration avoidance operation selection	0 to 2	1	0		
	883	G121	Regeneration avoidance operation level	300 to 1200 V	0.1 V	[100/200 V class] 400 V [400 V class] 780 V [575 V class] 944 V		
	885	G123	Regeneration avoidance compensation frequency limit value	0 to 45 Hz, 9999	0.01 Hz	6 Hz		
	886	G124	Regeneration avoidance voltage gain	0% to 200%	0.1%	100%		
Free parameter	888	E420	Free parameter 1	0 to 9999	1	9999		
	889	E421	Free parameter 2	0 to 9999	1	9999		
—	890	H325	Internal storage device status indication	(0 to 255)	1	0		
Energy saving monitoring	891	M023	Cumulative power monitor digit shifted times	0 to 4, 9999	1	9999		
	892	M200	Load factor	30% to 150%	0.1%	100%		
	893	M201	Energy saving monitor reference (motor capacity)	0.1 to 30 kW	0.01 kW	Applicable motor capacity		
	894	M202	Control selection during commercial power-supply operation	0 to 3	1	0		
	895	M203	Power saving rate reference value	0, 1, 9999	1	9999		
	896	M204	Power unit cost	0 to 500, 9999	0.01	9999		
	897	M205	Power saving monitor average time	0 to 1000 h, 9999	1 h	9999		
	898	M206	Power saving cumulative monitor clear	0, 1, 10, 9999	1	9999		
	899	M207	Operation time rate (estimated value)	0% to 100%, 9999	0.1%	9999		
	Position control	979	C194	Position accuracy compensation gain 1	90% to 110%, 9999	0.01%	9999	
980		C195	Position accuracy compensation gain 2	90% to 110%, 9999	0.01%	9999		
981		C196	Position accuracy compensation gain 3	90% to 110%, 9999	0.01%	9999		
—	986	H110	Display safety fault code [E800-SCE]	0 to 127	1	0		

Function	Pr.	Pr. group	Name	Setting range	Minimum setting increments	Initial value		Customer setting
						Gr.1	Gr.2	
PU	990	E104	PU buzzer control [E800]	0, 1	1	1		
	991	E105	PU contrast adjustment [E800]	0 to 63	1	58		
Monitoring	992	M104	Operation panel setting dial push monitor selection [E800]	0 to 3, 5 to 14, 17 to 20, 22 to 33, 35, 38, 40 to 42, 44, 45, 50 to 57, 61, 62, 64, 65, 67, 68, 71, 72, 81 to 84, 85 [E800-1], 86 [E800-4][E800-5], 91, 97, 100	1	0		
—	997	H103	Fault initiation	0 to 255, 9999	1	9999		
—	998	E430	PM parameter initialization Simple	0, 3024, 3044, 3124, 3144, 8009, 8109, 9009, 9109	1	0		
—	999	E431	Automatic parameter setting Simple	10, 12, 20, 21, 9999	1	9999		

◆ Pr.1000 to Pr.1099

Function	Pr.	Pr. group	Name	Setting range	Minimum setting increments	Initial value		Customer setting		
						Gr.1	Gr.2			
—	1002	C150	Lq tuning target current adjustment coefficient	50% to 150%, 9999	0.1%	9999				
Clock	1006	E020	Clock (year)	2000 to 2099	1	2000				
	1007	E021	Clock (month, day)	Jan. 1 to Dec. 31	1	101				
	1008	E022	Clock (hour, minute)	0:00 to 23:59	1	0				
—	1013	H323	Running speed after emergency drive retry reset [E800(-E)]	0 to 590 Hz	0.01 Hz	60 Hz	50 Hz			
—	1015	A607	Integral stop selection at limited frequency	0 to 2	1	0				
—	1016	H021	PTC thermistor protection detection time	0 to 60 s	1 s	0 s				
Trace	1020	A900	Trace operation selection	0 to 3	1	0				
	1022	A902	Sampling cycle	1, 2, 5, 10, 50, 100, 500, 1000	1	1				
	1023	A903	Number of analog channels	1 to 8	1	4				
	1024	A904	Sampling auto start	0, 1	1	0				
	1025	A905	Trigger mode selection	0 to 4	1	0				
	1026	A906	Number of sampling before trigger	0% to 100%	1%	90%				
	1027	A910	Analog source selection (1ch)	[E800] 1 to 3, 5 to 14, 17 to 20, 22 to 24, 32, 33, 35, 40 to 42, 52 to 54, 61, 62, 64, 65, 67, 68, 71, 72, 81 to 84, 85 [E800-1], 86 [E800-4][E800-5], 91, 97, 201 to 210, 212, 213, 222 to 227, 229 to 232, 235 to 238 [E800-(SC)E] 1 to 3, 5 to 14, 17 to 20, 22 to 24, 32, 33, 35, 40 to 42, 52 to 54, 61, 62, 64, 65, 67, 68 [E800-E], 71, 72, 83 [E800-(SC)EPA], 91, 97, 201 to 210, 212, 213, 222 to 227, 229 to 232, 235 to 238	1	201				
	1028	A911	Analog source selection (2ch)			202				
	1029	A912	Analog source selection (3ch)			203				
	1030	A913	Analog source selection (4ch)			204				
	1031	A914	Analog source selection (5ch)			205				
	1032	A915	Analog source selection (6ch)			206				
	1033	A916	Analog source selection (7ch)			207				
	1034	A917	Analog source selection (8ch)			208				
	1035	A918	Analog trigger channel			1 to 8	1	1		
	1036	A919	Analog trigger operation selection			0, 1	1	0		
	1037	A920	Analog trigger level	600 to 1400	1	1000				
	1038	A930	Digital source selection (1ch)	0 to 255	1	0				
	1039	A931	Digital source selection (2ch)			0				
	1040	A932	Digital source selection (3ch)			0				
1041	A933	Digital source selection (4ch)	0							
1042	A934	Digital source selection (5ch)	0							
1043	A935	Digital source selection (6ch)	0							
1044	A936	Digital source selection (7ch)	0							
1045	A937	Digital source selection (8ch)	0							
1046	A938	Digital trigger channel	1 to 8	1	1					
1047	A939	Digital trigger operation selection	0, 1	1	0					

Function	Pr.	Pr. group	Name	Setting range	Minimum setting increments	Initial value		Customer setting
						Gr.1	Gr.2	
Anti-sway control	1072	A310	DC brake judgment time for anti-sway control operation	0 to 10 s	0.1 s	3 s		
	1073	A311	Anti-sway control operation selection	0, 1	1	0		
	1074	A312	Anti-sway control frequency	0.05 to 3 Hz, 9999	0.001 Hz	9999		
	1075	A313	Anti-sway control depth	0 to 3	1	0		
	1076	A314	Anti-sway control width	0 to 3	1	0		
	1077	A315	Rope length	0.1 to 100 m	0.1 m	1 m		
	1078	A316	Trolley weight	0 to 50000 kg	1 kg	0 kg		
	1079	A317	Load weight	0 to 50000 kg	1 kg	0 kg		

◆ Pr.1100 to Pr.1399

Function	Pr.	Pr. group	Name	Setting range	Minimum setting increments	Initial value		Customer setting
						Gr.1	Gr.2	
—	1103*4	F040	Deceleration time at emergency stop	0 to 3600 s	0.1 s	5 s		
Monitoring	1106	M050	Torque monitor filter	0 to 5 s, 9999	0.01 s	9999		
	1107	M051	Running speed monitor filter	0 to 5 s, 9999	0.01 s	9999		
	1108	M052	Excitation current monitor filter	0 to 5 s, 9999	0.01 s	9999		
—	1124	N681	Station number in inverter-to-inverter link [E800-(SC)EPA][E800-(SC)EPB]	0 to 5, 9999	1	9999		
—	1125	N682	Number of inverters in inverter-to-inverter link system [E800-(SC)EPA][E800-(SC)EPB]	2 to 6	1	2		
PLC function	1150 to 1199	A810 to A859	PLC function user parameters 1 to 50	0 to 65535	1	0		
—	1200	M390	AM output offset calibration [E800-4][E800-5]	2700 to 3300	1	3000		
—	1210	N120	CC-Link IE TSN protocol version selection [E800-(SC)EPA][E800-(SC)EPB]	0, 9999	1	0		
—	1220	B100	Direct command mode selection [E800-(SC)E]	[E800-(SC)EPA][E800-(SC)EPB] 0, 3 [E800-EPC] 0, 4	1	0		
Position control	1222	B120	First positioning acceleration time	0.01 to 360 s	0.01 s	5 s		
	1223	B121	First positioning deceleration time	0.01 to 360 s	0.01 s	5 s		
	1225	B123	First positioning sub-function	0, 1, 10, 11, 100, 101, 110, 111	1	10		
	1226	B124	Second positioning acceleration time	0.01 to 360 s	0.01 s	5 s		
	1227	B125	Second positioning deceleration time	0.01 to 360 s	0.01 s	5 s		
	1229	B127	Second positioning sub-function	0, 1, 10, 11, 100, 101, 110, 111	1	10		
	1230	B128	Third positioning acceleration time	0.01 to 360 s	0.01 s	5 s		
	1231	B129	Third positioning deceleration time	0.01 to 360 s	0.01 s	5 s		
	1233	B131	Third positioning sub-function	0, 1, 10, 11, 100, 101, 110, 111	1	10		
	1234	B132	Fourth positioning acceleration time	0.01 to 360 s	0.01 s	5 s		
	1235	B133	Fourth positioning deceleration time	0.01 to 360 s	0.01 s	5 s		
	1237	B135	Fourth positioning sub-function	0, 1, 10, 11, 100, 101, 110, 111	1	10		
	1238	B136	Fifth positioning acceleration time	0.01 to 360 s	0.01 s	5 s		
	1239	B137	Fifth positioning deceleration time	0.01 to 360 s	0.01 s	5 s		
	1241	B139	Fifth positioning sub-function	0, 1, 10, 11, 100, 101, 110, 111	1	10		
	1242	B140	Sixth positioning acceleration time	0.01 to 360 s	0.01 s	5 s		
	1243	B141	Sixth positioning deceleration time	0.01 to 360 s	0.01 s	5 s		
1245	B143	Sixth positioning sub-function	0, 1, 10, 11, 100, 101, 110, 111	1	10			
1246	B144	Seventh positioning acceleration time	0.01 to 360 s	0.01 s	5 s			
1247	B145	Seventh positioning deceleration time	0.01 to 360 s	0.01 s	5 s			
1249	B147	Seventh positioning sub-function	0, 10, 100, 110	1	10			

Function	Pr.	Pr. group	Name	Setting range	Minimum setting increments	Initial value		Customer setting
						Gr.1	Gr.2	
Home position return	1282	B180	Home position return method selection	2, 3, 4, 6, 103, 106, 203, 206	1	4		
	1283	B181	Home position return speed	0 to 400 Hz	0.01 Hz	2 Hz		
	1285	B183	Home position shift amount lower 4 digits	0 to 9999	1	0		
	1286	B184	Home position shift amount upper 4 digits	0 to 9999	1	0		
	1289	B187	Home position return stopper torque	0% to 200%	0.1%	40%		
	1290	B188	Home position return stopper waiting time	0 to 10 s	0.1 s	0.5 s		
	1292	B190	Position control terminal input selection	0, 1, 10, 11, 100, 101, 110, 111	1	0		
Position detection	1293	B191	Roll feeding mode selection	0 to 2	1	0		
	1294	B192	Position detection lower 4 digits	0 to 9999	1	0		
	1295	B193	Position detection upper 4 digits	0 to 9999	1	0		
	1296	B194	Position detection selection	0 to 2	1	0		
	1297	B195	Position detection hysteresis width	0 to 32767	1	0		
—	1298	B013	Second position control gain	0 to 150 s-1	1 s-1	10 s-1		
—	1299	G108	Second pre-excitation selection	0, 1	1	0		
—	1305	N690	EtherCAT node address setting [E800-EPC]	0 to 65535	1	0		

2

Parameter list

Function	Pr.	Pr. group	Name	Setting range	Minimum setting increments	Initial value		Customer setting
						Gr.1	Gr.2	
User defined cyclic communication	1318	N800	User Defined Cyclic Communication Input fixing format selection [E800-(SC)EPA]	20 to 23, 9999	1	9999		
	1319	N801	User Defined Cyclic Communication Output fixing format selection [E800-(SC)EPA]	70 to 73, 9999	1	9999		
	1320	N810	User Defined Cyclic Communication Input 1 Mapping [E800-(SC)E]	[E800-(SC)EPA] 12288 to 13787, 20488, 20489, 24672, 24689, 24698, 24703, 24705, 24707, 24708, 24719, 24721, 24728 to 24730, 9999	1	[E800-(SC)EPA] [E800-(SC)EPB] 9999 [E800-EPC] 24642		
	1321 to 1329	N811 to N819	User Defined Cyclic Communication Input 2 to 10 Mapping [E800-(SC)E]	[E800-(SC)EPB] 5, 100, 12288 to 13787, 20488, 20489, 24672, 24689, 24698, 24703, 24705, 24707, 24708, 24719, 24721, 24728 to 24730, 9999 [E800-EPC] 12288 to 13787, 20488, 20489, 24642, 24646, 24648 to 24650, 24672, 24677 to 24680, 24689, 24698, 24702, 24703, 24705, 24707 to 24709, 24719, 24721, 24728 to 24730, 24831, 9999		9999		
	1330	N850	User Defined Cyclic Communication Output 1 Mapping [E800-(SC)E]	[E800-(SC)EPA][E800-EPC] 12288 to 13787, 16384 to 16483, 20488, 20489, 20981 to 20990, 20992 [E800-E], 24639, 24643, 24644, 24673 to 24676, 24692, 24695, 24820, 24826, 24828, 25858, 9999	1	[E800-(SC)EPA] [E800-(SC)EPB] 9999 [E800-EPC] 24643		
	1331 to 1343	N851 to N863	User Defined Cyclic Communication Output 2 to 14 Mapping [E800-(SC)E]	[E800-(SC)EPB] 6, 101, 12288 to 13787, 16384 to 16483, 20488, 20489, 20981 to 20990, 20992 [E800-E], 24639, 24643, 24644, 24673 to 24676, 24692, 24695, 24820, 24826, 24828, 25858, 9999		9999		
—	1386	N652	Ethernet relay operation at reset selection [E800-(SC)EPA][E800-(SC)EPB]	0, 9999	1	0		

Function	Pr.	Pr. group	Name	Setting range	Minimum setting increments	Initial value		Customer setting
						Gr.1	Gr.2	
User defined cyclic communication	1389 to 1393	—	User Defined Cyclic Communication Input Sub 1 and 2 Mapping to User Defined Cyclic Communication Input Sub 9 and 10 Mapping [E800-(SC)E]	0 to 2, 256 to 258, 512 to 514	1	0		
		N830 to N839	User Defined Cyclic Communication Input Sub 1 to 10 Mapping [E800-(SC)E]	0 to 2	1	0		
	1394 to 1398	—	User Defined Cyclic Communication Output Sub 1 and 2 Mapping to User Defined Cyclic Communication Output Sub 9 and 10 Mapping [E800-(SC)E]	0 to 2, 256 to 258, 512 to 514	1	0		
		N870 to N879	User Defined Cyclic Communication Output Sub 1 to 10 Mapping [E800-(SC)E]	0 to 2	1	0		
—	1399	N649	Inverter identification enable/disable selection [E800-(SC)EPA][E800-(SC)EPB]	0, 1	1	1		

◆ Pr.1400 to Pr.1499

Function	Pr.	Pr. group	Name	Setting range	Minimum setting increments	Initial value		Customer setting
						Gr.1	Gr.2	
—	1412	C135	Motor induced voltage constant (phi f) exponent	0 to 2, 9999	1	9999		
—	1413	C235	Second motor induced voltage constant (phi f) exponent	0 to 2, 9999	1	9999		
Ethernet function selection	1424	N650	Ethernet communication network number [E800-(SC)EPA][E800-(SC)EPB]	1 to 239	1	1		
	1425	N651	Ethernet communication station number [E800-(SC)EPA][E800-(SC)EPB]	1 to 120	1	1		
	1426	N641	Link speed and duplex mode selection [E800-(SC)EPA][E800-(SC)EPB]	0 to 4	1	0		
	1427	N630	Ethernet function selection 1 [E800-(SC)EPA][E800-(SC)EPB]	[E800-(SC)EPA] 502, 5000 to 5002, 5006 to 5008, 5010 to 5013, 44818, 45237, 45238, 47808, 61450, 9999	1	5001		
	1428	N631	Ethernet function selection 2 [E800-(SC)EPA][E800-(SC)EPB]	[E800-(SC)EPA] 502, 5000 to 5002, 5006 to 5008, 5010 to 5013, 34962, 45237, 45238, 61450, 9999	1	45237		
	1429	N632	Ethernet function selection 3 [E800-(SC)EPA][E800-(SC)EPB]	[E800-(SC)EPA] 502, 5000 to 5002, 5006 to 5008, 5010 to 5013, 34962, 45237, 45238, 61450, 9999	1	45238		
	1430	N633	Ethernet function selection 4 [E800-(SC)EPA][E800-(SC)EPB]		1	9999		
	1431	N643	Ethernet signal loss detection function selection [E800-(SC)E]	0 to 3	1	3		
	1432	N644	Ethernet communication check time interval [E800-(SC)EPA][E800-(SC)EPB]	0 to 999.8 s, 9999	0.1 s	1.5		
	1434	N600	IP address 1 (Ethernet) [E800-(SC)EPA][E800-(SC)EPB]	0 to 255	1	192		
	1435	N601	IP address 2 (Ethernet) [E800-(SC)EPA][E800-(SC)EPB]	0 to 255	1	168		
	1436	N602	IP address 3 (Ethernet) [E800-(SC)EPA][E800-(SC)EPB]	0 to 255	1	50		
	1437	N603	IP address 4 (Ethernet) [E800-(SC)EPA][E800-(SC)EPB]	0 to 255	1	1		

Function	Pr.	Pr. group	Name	Setting range	Minimum setting increments	Initial value		Customer setting
						Gr.1	Gr.2	
Ethernet	1438	N610	Subnet mask 1 [E800-(SC)EPA][E800-(SC)EPB]	0 to 255	1	255		
	1439	N611	Subnet mask 2 [E800-(SC)EPA][E800-(SC)EPB]	0 to 255	1	255		
	1440	N612	Subnet mask 3 [E800-(SC)EPA][E800-(SC)EPB]	0 to 255	1	255		
	1441	N613	Subnet mask 4 [E800-(SC)EPA][E800-(SC)EPB]	0 to 255	1	0		
	1442	N660	IP filter address 1 (Ethernet) [E800-(SC)EPA][E800-(SC)EPB]	0 to 255	1	0		
	1443	N661	IP filter address 2 (Ethernet) [E800-(SC)EPA][E800-(SC)EPB]	0 to 255	1	0		
	1444	N662	IP filter address 3 (Ethernet) [E800-(SC)EPA][E800-(SC)EPB]	0 to 255	1	0		
	1445	N663	IP filter address 4 (Ethernet) [E800-(SC)EPA][E800-(SC)EPB]	0 to 255	1	0		
	1446	N664	IP filter address 2 range specification (Ethernet) [E800-(SC)EPA][E800-(SC)EPB]	0 to 255, 9999	1	9999		
	1447	N665	IP filter address 3 range specification (Ethernet) [E800-(SC)EPA][E800-(SC)EPB]	0 to 255, 9999	1	9999		
	1448	N666	IP filter address 4 range specification (Ethernet) [E800-(SC)EPA][E800-(SC)EPB]	0 to 255, 9999	1	9999		
	1449	N670	Ethernet command source selection IP address 1 [E800-(SC)EPA][E800-(SC)EPB]	0 to 255	1	0		
	1450	N671	Ethernet command source selection IP address 2 [E800-(SC)EPA][E800-(SC)EPB]	0 to 255	1	0		
	1451	N672	Ethernet command source selection IP address 3 [E800-(SC)EPA][E800-(SC)EPB]	0 to 255	1	0		
	1452	N673	Ethernet command source selection IP address 4 [E800-(SC)EPA][E800-(SC)EPB]	0 to 255	1	0		
	1453	N674	Ethernet command source selection IP address 3 range specification [E800-(SC)EPA][E800-(SC)EPB]	0 to 255, 9999	1	9999		
	1454	N675	Ethernet command source selection IP address 4 range specification [E800-(SC)EPA][E800-(SC)EPB]	0 to 255, 9999	1	9999		
	1455	N642	Keepalive time [E800-(SC)EPA][E800-(SC)EPB]	1 to 7200 s	1	60 s		
1456	N647	Network diagnosis selection [E800-(SC)EPA][E800-(SC)EPB]	0 to 2, 9999	1	9999			
1457	N648	Extended setting for Ethernet signal loss detection function selection [E800-(SC)EPA][E800-(SC)EPB]	0 to 3, 8888, 9999	1	9999			
Load characteristics fault detection	1480	H520	Load characteristics measurement mode	0, 1 (2 to 5, 81 to 85)	1	0		
	1481	H521	Load characteristics load reference 1	0% to 400%, 8888, 9999	0.1%	9999		
	1482	H522	Load characteristics load reference 2	0% to 400%, 8888, 9999	0.1%	9999		
	1483	H523	Load characteristics load reference 3	0% to 400%, 8888, 9999	0.1%	9999		
	1484	H524	Load characteristics load reference 4	0% to 400%, 8888, 9999	0.1%	9999		
	1485	H525	Load characteristics load reference 5	0% to 400%, 8888, 9999	0.1%	9999		
	1486	H526	Load characteristics maximum frequency	0 to 590 Hz	0.01 Hz	60 Hz	50 Hz	
	1487	H527	Load characteristics minimum frequency	0 to 590 Hz	0.01 Hz	6 Hz		
	1488	H531	Upper limit warning detection width	0% to 400%, 9999	0.1%	20%		
	1489	H532	Lower limit warning detection width	0% to 400%, 9999	0.1%	20%		
	1490	H533	Upper limit fault detection width	0% to 400%, 9999	0.1%	9999		
	1491	H534	Lower limit fault detection width	0% to 400%, 9999	0.1%	9999		
1492	H535	Load status detection signal delay time / load reference measurement waiting time	0 to 60 s	0.1 s	1 s			
—	1499	E415	Parameter for manufacturer setting. Do not set.					

◆ Alphabet (calibration parameters, etc.)

Function	Pr.	Pr. group	Name	Setting range	Minimum setting increments	Initial value		Customer setting
						Gr.1	Gr.2	
Calibration parameter	C0 (900)*6	M310	FM terminal calibration [E800-1]	—	—	—		
	C1 (901)*6	M320	AM terminal calibration [E800-4][E800-5]	—	—	—		
	C2 (902)*6	T200	Terminal 2 frequency setting bias frequency	0 to 590 Hz	0.01 Hz	0 Hz		
	C3 (902)*6	T201	Terminal 2 frequency setting bias	0% to 300%	0.1%	0%		
	125 (903)*6	T202	Terminal 2 frequency setting gain frequency	0 to 590 Hz	0.01 Hz	60 Hz	50 Hz	
	C4 (903)*6	T203	Terminal 2 frequency setting gain	0% to 300%	0.1%	100%		
	C5 (904)*6	T400	Terminal 4 frequency setting bias frequency	0 to 590 Hz	0.01 Hz	0 Hz		
	C6 (904)*6	T401	Terminal 4 frequency setting bias	0% to 300%	0.1%	20%		
	126 (905)*6	T402	Terminal 4 frequency setting gain frequency	0 to 590 Hz	0.01 Hz	60 Hz	50 Hz	
	C7 (905)*6	T403	Terminal 4 frequency setting gain	0% to 300%	0.1%	100%		
	C38 (932)*6	T410	Terminal 4 bias command (torque)	0% to 400%	0.1%	0%		
	C39 (932)*6	T411	Terminal 4 bias (torque)	0% to 300%	0.1%	0%		
	C40 (933)*6	T412	Terminal 4 gain command (torque)	0% to 400%	0.1%	150%		
	C41 (933)*6	T413	Terminal 4 gain (torque)	0% to 300%	0.1%	100%		
	PID display	C42 (934)*6	A630	PID display bias coefficient	0 to 500, 9999	0.01	9999	
C43 (934)*6		A631	PID display bias analog value	0% to 300%	0.1%	20%		
C44 (935)*6		A632	PID display gain coefficient	0 to 500, 9999	0.01	9999		
C45 (935)*6		A633	PID display gain analog value	0% to 300%	0.1%	100%		
Clear parameters	PR.CL		Parameter clear	(0), 1	1	0		
	ALLC		All parameter clear	(0), 1	1	0		
	ER.CL		Fault history clear	(0), 1	1	0		
—	PR.CH		Initial value change list	—	1	0		
—	PM		PM parameter initialization	0	1	0		
—	AUTO		Automatic parameter setting	—	—	—		
—	PR.MD		Group parameter setting	(0), 1, 2	1	0		

- *1 Differs depending on the capacity.
6%: FR-E820-0050(0.75K) or lower, FR-E840-0026(0.75K) or lower, FR-E820S-0050(0.75K) or lower, and FR-E810W-0050(0.75K) or lower
5%: FR-E860-0017(0.75K)
4%: FR-E820-0080(1.5K) to FR-E820-0175(3.7K), FR-E840-0040(1.5K) to FR-E840-0095(3.7K), and FR-E820S-0080(1.5K) or higher
3%: FR-E820-0240(5.5K), FR-E820-0330(7.5K), FR-E840-0120(5.5K), FR-E840-0170(7.5K), FR-E860-0027(1.5K), and FR-E860-0040(2.2K)
2%: FR-E820-0470(11K) or higher, FR-E840-0230(11K) or higher, and FR-E860-0061(3.7K) or higher
- *2 Differs depending on the capacity.
5 s: FR-E820-0175(3.7K) or lower, FR-E840-0095(3.7K) or lower, FR-E860-0061(3.7K) or lower, FR-E820S-0110(2.2K) or lower, and FR-E810W-0050(0.75K) or lower
10 s: FR-E820-0240(5.5K), FR-E820-0330(7.5K), FR-E840-0120(5.5K), FR-E840-0170(7.5K), and FR-E860-0090(5.5K) or higher
15 s: FR-E820-0470(11K) or higher and FR-E840-0230(11K) or higher
- *3 Differs depending on the capacity.
6%: FR-E820-0015(0.2K) or lower, FR-E820S-0015(0.2K) or lower, and FR-E810W-0015(0.2K) or lower
4%: FR-E820-0030(0.4K) to FR-E820-0330(7.5K), FR-E840-0016(0.4K) to FR-E840-0170(7.5K), FR-E820S-0030(0.4K) or higher, and FR-E810W-0030(0.4K) or higher
2%: FR-E820-0470(11K) or higher and FR-E840-0230(11K) or higher
1%: FR-E860-0017(0.75K) or higher
- *4 The set value is read/written in 2-word (32-bit) units when the PLC function is used for parameter reading/writing.
- *5 The setting is available only when a Vector control compatible option is installed. (The parameter can be read or written using communication protocols regardless of whether the option is installed.)
- *6 On the LCD operation panel or the parameter unit used as the command source, the parameter number in parentheses appears instead of that starting with the letter C.
- *7 For the Ethernet model and the safety communication model, the setting is available only when the FR-A8AY is installed.
- *8 Available when the PLC function is enabled. (Pr.313 to Pr.315 are always available for settings in the Ethernet model and the safety communication model.)
- *9 For the standard model, the setting is available only when a communication option is installed.

Protective Functions

● Error message

A message regarding operational fault or setting fault on the operation panel is displayed. The inverter output is not shut off.

Operation panel indication	Name	Description
Hold	HOLD	Operation panel lock Operation lock is set. Operation other than pressing the STOP/RESET key is disabled.
LoCd	LOCD	Password locked Password function is active. Display and setting of parameters are restricted.
Er 1 to Er 4	Er1 to Er4	Parameter write error Appears when an error occurred during parameter writing.
Err.	Err.	Error <ul style="list-style-type: none"> The RES signal is turned ON. This error may occur when the voltage at the input side of the inverter drops.

● Warning

The inverter output is not shut off even when a warning is displayed. However, failure to take appropriate measures will lead to a fault.

Operation panel indication	Name	Data code	Description
oLc	OLC	1 (H01)	When the output current of the inverter increases, the stall prevention (overcurrent) function is activated.
oLv	OLV	2 (H02)	<ul style="list-style-type: none"> When the output voltage of the inverter increases, the stall prevention (overvoltage) function is activated. The regeneration avoidance function is activated due to excessive regenerative power of the motor.
rB	RB	3 (H03)	Regenerative brake pre-alarm Appears if the actual regenerative brake duty reaches or exceeds 85% of the reference regenerative brake duty (100%) determined by the settings of Pr.30 Regenerative function selection and Pr.70 Special regenerative brake duty . If the regenerative brake duty reaches 100%, a regenerative overvoltage (E.OV[]) occurs.
rH	TH	4 (H04)	Electronic thermal relay function pre-alarm Appears if the cumulative value of the electronic thermal O/L relay reaches or exceeds 85% of the preset level of Pr.9 Electronic thermal O/L relay .
PS	PS	6 (H06)	PU stop <ul style="list-style-type: none"> The motor is stopped using the STOP/RESET key under the mode other than the PU operation mode. The motor is stopped by the emergency stop function.
SL	SL	9 (H09)	Output if the speed limit level is exceeded during torque control.
SA	SA	12 (H0C)	Appears when safety stop function is activated (during output shutoff).
MT	MT	8 (H08)	Maintenance timer *3 Appears when the inverter's cumulative energization time reaches or exceeds the parameter set value.
CF	CF	10 (H0A)	Appears when the operation continues while an error is occurring in the communication line or communication option (when Pr.502 = "4").
Ldf	LDF	26 (H1A)	Appears when the load is deviated from the detection width set in Pr.1488 Upper limit warning detection width or Pr.1489 Lower limit warning detection width .
Ehr	EHR	28 (H1C)	Appears when Ethernet communication is interrupted by physical factors while Pr.1431 Ethernet signal loss detection function selection = "1 to 3".
dIP	DIP	32 (H20)	Appears when duplicate IP address is detected.
iP	IP	38 (H26)	Appears when the IP address or the subnet mask is out of the specified range.
SE	SE	48 (H30)	Appears when a start command is input while the condition to start operation is not satisfied in the motor setting (Pr.71 , Pr.450 , Pr.80 , Pr.453 , Pr.81 , or Pr.454) for the control method selected in Pr.800 or Pr.451 .
Cor	Cor	50 (H32)	Appears when the corrosion level of the control circuit board becomes "3" (Pr.198 = "3"). (Available only for the FR-E8[]-[]-60 (with coating).)
Uv	UV	-	If the power supply voltage of the inverter decreases, the control circuit will not perform normal functions. In addition, the motor torque will be insufficient and/or heat generation will increase. To prevent this, if the power supply voltage decreases to about 115 VAC (230 VAC for the 400 V class, 330 VAC for the 575 V class) or below, this function shuts off the inverter output and "UV" is displayed. The warning is removed when the voltage returns to normal.
LP	LP	20 (H14)	Appears when the Forward stroke end (LSP) signal or the Reverse stroke end (LSN) signal is assigned to the input terminal and the signal is turned OFF (normally closed input).
HP1	HP1	21 (H15)	Appears when an error occurs during the home position return operation under position control.
HP2	HP2	22 (H16)	
Ed	ED	24 (H18)	Appears during emergency drive operation.

● Alarm

The inverter output is not shut off. An Alarm (LF) signal can also be output with a parameter setting.

Operation panel indication		Name	Description
<i>F_n</i>	FN	Fan alarm	For the inverter that contains a cooling fan, FN appears on the operation panel when the cooling fan stops due to a fault, low rotation speed, or different operation from the setting of Pr.244 Cooling fan operation selection .

● Fault

When a protective function is activated, the inverter output is shut off and a Fault (ALM) signal is output.

The data code is used for checking the fault detail via communication or with **Pr.997 Fault initiation**.

◆ Data code 16 to 199

Operation panel indication		Name	Data code	Description
<i>E.oC1</i>	E.OC1	Overcurrent trip during acceleration	16 (H10)	When the inverter output current reaches or exceeds approximately 230%*5 of the rated current during acceleration, the protection circuit is activated and the inverter output is shut off.
<i>E.oC2</i>	E.OC2	Overcurrent trip during constant speed	17 (H11)	When the inverter output current reaches or exceeds approximately 230%*5 of the rated current during constant speed operation, the protection circuit is activated and the inverter output is shut off.
<i>E.oC3</i>	E.OC3	Overcurrent trip during deceleration or stop	18 (H12)	When the inverter output current reaches or exceeds approximately 230%*5 of the rated current during deceleration (other than acceleration or constant speed), the protection circuit is activated and the inverter output is shut off.
<i>E.ov1</i>	E.OV1	Regenerative overvoltage trip during acceleration	32 (H20)	If regenerative power causes the inverter's internal main circuit DC voltage to reach or exceed the specified value, the protection circuit is activated to stop the inverter output. The circuit may also be activated by a surge voltage produced in the power supply system.
<i>E.ov2</i>	E.OV2	Regenerative overvoltage trip during constant speed	33 (H21)	If regenerative power causes the inverter's internal main circuit DC voltage to reach or exceed the specified value, the protection circuit is activated to stop the inverter output. The circuit may also be activated by a surge voltage produced in the power supply system.
<i>E.ov3</i>	E.OV3	Regenerative overvoltage trip during deceleration or stop	34 (H22)	If regenerative power causes the inverter's internal main circuit DC voltage to reach or exceed the specified value, the protection circuit is activated to stop the inverter output. The circuit may also be activated by a surge voltage produced in the power supply system.
<i>E.fHT</i>	E.THT	Inverter overload trip (electronic thermal relay function)*1	48 (H30)	If the temperature of the output transistor elements exceeds the protection level with a rated output current or higher flowing without the overcurrent trip (E.OC[]), the inverter output is stopped. (Overload capacity 150% 60 s)
<i>E.fHN</i>	E.THM	Motor overload trip (electronic thermal relay function)*1	49 (H31)	The electronic thermal O/L relay function in the inverter detects motor overheat, which is caused by overload or reduced cooling capability during low-speed operation. When the cumulative heat value reaches 85% of the Pr.9 Electronic thermal O/L relay setting, pre-alarm (TH) is output. When the accumulated value reaches the specified value, the protection circuit is activated to stop the inverter output.
<i>E.F_n</i>	E.FIN	Heat sink overheat	64 (H40)	When the heat sink overheats, the temperature sensor is activated, and the inverter output is stopped.
<i>E.Uvf</i>	E.UVT	Undervoltage	81 (H51)	When a PM motor is used, the protective function is activated in the following case: a fault such as power failure or voltage drop occurs, the converter voltage drops to cause the motor to coast, and restarting and coasting are repeated by the automatic restart after instantaneous power failure function.
<i>E.LF</i>	E.ILF	Input phase loss*3	82 (H52)	When Pr.872 Input phase loss protection selection is enabled ("1") and one of the three-phase power input is lost, the inverter output is shut off. (This protective function is available for the three-phase power input model.)
<i>E.OLf</i>	E.OLT	Stall prevention stop	96 (H60)	If the output frequency has fallen to 0.5 Hz by stall prevention operation and remains for 3 seconds, a fault (E.OLT) appears and the inverter is shut off. OLC or OLV appears while stall prevention is being activated.
<i>E.Sof</i>	E.SOT	Loss of synchronism detection	97 (H61)	The inverter output is shut off when the motor operation is not synchronized. (This function is only available under PM sensorless vector control.)
<i>E.LUP</i>	E.LUP	Upper limit fault detection*3	98 (H62)	The inverter output is shut off when the load exceeds the upper limit fault detection range.
<i>E.Ldn</i>	E.LDN	Lower limit fault detection*3	99 (H63)	The inverter output is shut off when the load falls below the lower limit fault detection range.
<i>E.bE</i>	E.BE	Brake transistor alarm detection	112 (H70)	The inverter output is shut off if a fault due to damage of the brake transistor and such occurs in the brake circuit. In such a case, the power supply to the inverter must be shut off immediately.
<i>E.GF</i>	E.GF	Output side earth (ground) fault overcurrent	128 (H80)	The inverter output is shut off if an earth (ground) fault overcurrent flows due to an earth (ground) fault that occurred on the inverter's output side (load side).
<i>E.LF</i>	E.LF	Output phase loss	129 (H81)	The inverter output is shut off if one of the three phases (U, V, W) on the inverter's output side (load side) is lost.
<i>E.oHT</i>	E.OHT	External thermal relay operation*2*3	144 (H90)	The inverter output is shut off if the external thermal relay provided for motor overheat protection or the internally mounted thermal relay in the motor, etc. switches ON (contacts open). (This protective function is available for the standard model and the Ethernet model.)

Operation panel indication		Name	Data code	Description
E.PTC	E.PTC	PTC thermistor operation*3	145 (H91)	The inverter output is shut off if resistance of the PTC thermistor connected between terminal 2 and terminal 10 is equal to or higher than the Pr.561 PTC thermistor protection level setting for a continuous time equal to or longer than the setting value in Pr.1016 PTC thermistor protection detection time .
E.oPf	E.OPT	Option fault	160 (HA0)	<ul style="list-style-type: none"> Appears when the AC power supply is connected to terminal R/L1, S/L2, or T/L3 accidentally when a high power factor converter (FR-HC2) or multifunction regeneration converter (FR-XC in common bus regeneration mode) is connected (when Pr.30 Regenerative function selection = "0 or 2"). Appears when the switch for manufacturer setting of the plug-in option is changed. Appears when a communication option is connected while Pr.296 Password lock level = "0 or 100".
E.oP1	E.OP1	Communication option fault	161 (HA1)	The inverter output is shut off if a communication line error occurs in the communication option.
E. 16	E.16	User definition error by the PLC function*3	164 (HA4)	The protective function is activated by setting "16 to 20" in the special register SD1214 for the PLC function. The inverter output is shut off when the protective function is activated. The protective function is activated when the PLC function is enabled.
E. 17	E.17		165 (HA5)	
E. 18	E.18		166 (HA6)	
E. 19	E.19		167 (HA7)	
E. 20	E.20		168 (HA8)	
E.PE6	E.PE6	Internal storage device fault	172 (HAC)	This protective function is activated by an inverter reset if writing data fails due to power-OFF or a data fault occurs in the storage device during parameter operations*4.
E.PE	E.PE	Parameter storage device fault (control circuit board)	176 (HB0)	The inverter output is shut off if a fault occurs in the parameter stored. (EEPROM failure)
E.PUE	E.PUE	PU disconnection	177 (HB1)	<ul style="list-style-type: none"> The inverter output is shut off if communication between the inverter and PU is suspended, e.g. the cable is disconnected from the PU connector, when the disconnected PU detection function is valid in Pr.75 Reset selection/disconnected PU detection/PU stop selection. The inverter output is shut off if communication errors occurred consecutively for more than permissible number of retries when Pr.121 PU communication retry count ≠ "9999" during the RS-485 communication. The inverter output is shut off if communication is broken within the period of time set in Pr.122 PU communication check time interval during the RS-485 communication via the PU connector. (This protective function is available for the standard model.)
E.rEt	E.RET	Retry count excess*3	178 (HB2)	The inverter output is shut off if the operation cannot be resumed properly within the number of retries set in Pr.67 Number of retries at fault occurrence .
E.PE2	E.PE2	Parameter storage device fault (main circuit board)	179 (HB3)	The inverter output is shut off if a fault occurs in the inverter model information.
E.CPU	E.CPU	CPU fault	192 (HC0)	The inverter output is shut off if the communication fault of the built-in CPU occurs.
E.Ldo	E.CDO	Inrush current limit circuit fault*3	196 (HC4)	The inverter output is shut off if the output current exceeds the Pr.150 Output current detection level setting.
E.ioH	E.IOH	Analog input fault	197 (HC5)	The inverter output is shut off when the resistor of the inrush current limit circuit is overheated. The inrush current limit circuit is faulty.
E.A.IE	E.AIE	Communication option fault	199 (HC7)	The inverter output is shut off when a 30 mA or higher current or a 7.5 V or higher voltage is input to terminal 2 while the current input is selected by Pr.73 Analog input selection , or to terminal 4 while the current input is selected by Pr.267 Terminal 4 input selection .

◆ Data code 200 or more

Operation panel indication		Name	Data code	Description
E.USB	E.USB	USB communication fault	200 (HC8)	The inverter output is shut off when the communication is cut off for the time set in Pr.548 USB communication check time interval .
E.SAF	E.SAF	Safety circuit fault	201 (HC9)	<p>[Standard model / Ethernet model]</p> <ul style="list-style-type: none"> The inverter output is shut off when a safety circuit fault occurs. The inverter output is shut off if the either of the wire between S1 and SIC or S2 and SIC becomes nonconductive while using the safety stop function. When the safety stop function is not used, the inverter output is shut off when the shorting wire between terminals S1 and PC or across S2 and PC is disconnected. <p>[Safety communication model]</p> <ul style="list-style-type: none"> When a fault related to functional safety occurs, the inverter output is shut off by the protective function.
E.oS	E.OS	Overspeed occurrence*3	208 (HD0)	The inverter output is shut off when the motor speed exceeds the Pr.374 Overspeed detection level under encoder feedback control, Real sensorless vector control, Vector control, and PM sensorless vector control.
E.oSd	E.OSD	Speed deviation excess detection	209 (HD1)	When Pr.285 Speed deviation excess detection frequency is set during Vector control or PM sensorless vector control, if the motor speed is increased or decreased by factors such as influence of the load and cannot be controlled in accordance with the speed command value, the deceleration check function (Pr.690) is activated to stop the inverter output.
E.ECT	E.ECT	Signal loss detection*3*6	210 (HD2)	The inverter output is shut off when the encoder signal is shut off under orientation control, encoder feedback control, or Vector control.

Operation panel indication		Name	Data code	Description
E.OD	E.OD	Excessive position fault*3*6	211 (HD3)	The inverter output is shut off when the difference between the position command and position feedback exceeds Pr.427 Excessive level error during position control.
E.Nb1	E.MB1	Brake sequence fault*3	213 (HD5)	The inverter output is shut off when a sequence error occurs during use of the brake sequence function (Pr.278 to Pr.285).
E.Nb2	E.MB2		214 (HD6)	
E.Nb3	E.MB3		215 (HD7)	
E.Nb4	E.MB4		216 (HD8)	
E.Nb5	E.MB5		217 (HD9)	
E.Nb6	E.MB6		218 (HDA)	
E.Nb7	E.MB7		219 (HDB)	
E.OA	E.OA	Acceleration error*3	221 (HDD)	The acceleration error (E.OA) occurs and the inverter output is shut off when the acceleration rate of the motor rotation speed has exceeded the faulty acceleration rate detection level (Pr.375).
E.P.d	E.PID	PID signal fault*3	230 (HE6)	The inverter output is shut off if the measured value exceeds the PID upper limit or PID lower limit parameter setting, or the absolute deviation value exceeds the PID deviation parameter setting during PID control.
E.EHr	E.EHR	Ethernet communication fault	231 (HE7)	<ul style="list-style-type: none"> • Appears when Ethernet communication is interrupted by physical factors while Pr.1431 Ethernet signal loss detection function selection = "3" or Pr.1457 Ethernet signal loss detection function selection (extended setting) = "3". • The inverter output is shut off if Ethernet communication is broken for the time set in Pr.1432 Ethernet communication check time interval or longer for all devices with IP addresses in the range specified for Ethernet command source selection (Pr.1449 to Pr.1454). • When the CC-Link IE Field Network Basic is used, the inverter output is shut off in the following cases: the data addressed to the own station is not received for the predetermined timeout period or longer, or the status bit of the cyclic transmission addressed to the own station turns OFF (when the master inverter gives a command to stop the cyclic transmission). • When BACnet/IP is used, the inverter output will be shut off after the time period set in Pr.1432 after power is supplied to the inverter if an IP address of any other inverter falls within the Ethernet IP address range set for command source selection. (This protective function is available for the Ethernet model and the safety communication model.)
E.CNb	E.CMB	Board combination mismatch	232 (HE8)	Appears when the combination of the circuit board and the inverter is not appropriate.
E. 1	E.1	Option fault	241 (HF1)	<ul style="list-style-type: none"> • The inverter output is shut off when a contact failure occurs between the inverter and the plug-in option. • Appears when the switch for manufacturer setting of the plug-in option is changed.
E. 5	E.5	CPU fault	245 (HF5)	The inverter output is shut off if the communication fault of the built-in CPU occurs.
E. 6	E.6		246 (HF6)	
E. 7	E.7		247 (HF7)	
E. 10	E.10	Inverter output fault	250 (HFA)	The inverter output is shut off if the inverter detects an output current fault such as an earth (ground) fault that occurred on the inverter's output side (load side).
E. 11	E.11	Opposite rotation deceleration fault*3	251 (HFB)	The speed may not decelerate during low speed operation if the rotation direction of the speed command and the estimated speed differ when the rotation is changing from forward to reverse or from reverse to forward during torque control under Real sensorless vector control. The inverter output is shut off when overload occurs due to the un-switched rotation direction.
E. 13	E.13	Internal circuit fault	253 (HFD)	Appears when the internal circuit is faulty.

● Others

The fault history and the operation status of the inverter are displayed. It is not a fault indication.

Operation panel indication	Name	Description
E - - -	Fault history	The operation panel stores the fault indications which appear when a protective function is activated to display the fault record for the past 10 faults.
E 0	No fault history	Appears when no fault records are stored. (Appears when the fault history is cleared after the protective function has been activated.)
Eu	24 V external power supply operation	Blinks when the main circuit power supply is OFF and power is supplied from a 24 V external power supply. This function is available when the FR-E8DS is installed.
rd	Backup in progress	Backup operation is in progress to back up inverter parameters and the data used in the PLC function to a computer.
br	Restoration in progress	Restore operation is in progress to restore the backup data stored in the computer in the inverter.

*1 Resetting the inverter initializes the internal cumulative heat value of the electronic thermal O/L relay function.

*2 The external thermal operates only when the OH signal is set in **Pr.178 to Pr.189 (input terminal function selection)**.

*3 This protective function is not available in the initial status.

*4 For example, when parameter clear, All parameter clear, Parameter copy, or offline auto tuning is performed in the inverter, or when parameter batch write is performed in FR Configurator2.

*5 Differs according to ratings. The rating can be changed using **Pr.570 Multiple rating setting**.

Three-phase input:

170% for LD rating, 230% for ND rating (initial setting) (FR-E820-0175(3.7K) or lower, FR-E840-0095(3.7K) or lower, FR-E860-0061(3.7K) or lower), and 235% for ND rating (initial value) (FR-E820-0240(5.5K) or higher, FR-E840-0120(5.5K) or higher, FR-E860-0090(5.5K) or higher)

Single-phase input:

180% for LD rating, 280% for ND rating (initial setting) (FR-E820S-0015(0.2K) or lower), and 230% for ND rating (initial value) (FR-E820S-0030(0.4K) or higher)

Single-phase input:

280% (FR-E820S-0015(0.2K) or lower) or 230% (FR-E820S-0030(0.4K) or higher) for ND rating.

*6 Appears when a vector control compatible option is installed.

Standard Specifications

◆ Rating

◆ Three-phase 200 V class

Model FR-E820-□		0008 0015 0030 0050 0080 0110 0175 0240 0330 0470 0600 0760 0900														
		0.1K 0.2K 0.4K 0.75K 1.5K 2.2K 3.7K 5.5K 7.5K 11K 15K 18.5K 22K														
Applicable motor capacity (kW)*1	LD	0.2	0.4	0.75	1.1	2.2	3.0	5.5	7.5	11.0	15.0	18.5	22.0	30.0		
	ND	0.1	0.2	0.4	0.75	1.5	2.2	3.7	5.5	7.5	11.0	15.0	18.5	22.0		
Rated capacity (kVA)*2	LD	0.5	0.8	1.4	2.4	3.8	4.8	7.8	12.0	15.9	22.3	27.5	35.1	45.8		
	ND	0.3	0.6	1.2	2.0	3.2	4.4	7.0	9.6	13.1	18.7	23.9	30.3	35.9		
Rated current (A)*7	LD	1.3 (1.1)	2.0 (1.7)	3.5 (3.0)	6.0 (5.1)	9.6 (8.2)	12.0 (10.2)	19.6 (16.7)	30.0 (25.5)	40.0 (34.0)	56.0 (47.6)	69.0 (58.7)	88.0 (74.8)	115.0 (97.8)		
	ND	0.8 (0.8)	1.5 (1.4)	3.0 (2.5)	5.0 (4.1)	8.0 (7.0)	11.0 (10.0)	17.5 (16.5)	24.0 (23.0)	33.0 (31.0)	47.0 (44.0)	60.0 (57.0)	76.0 (72.0)	90.0 (86.0)		
Overload current rating*3	LD	120% 60 s, 150% 3 s (inverse-time characteristics) at surrounding air temperature of 50°C														
	ND	150% 60 s, 200% 3 s (inverse-time characteristics) at surrounding air temperature of 50°C														
Voltage*4		Three-phase 200 to 240 V														
Regenerative braking	Brake transistor	Not installed														
	Maximum brake torque (ND reference)*5	150%			100%			50%		20%						
Rated input AC (DC) voltage/frequency		Three-phase 200 to 240 V 50/60 Hz (283 to 339 VDC *9)														
Permissible AC (DC) voltage fluctuation		170 to 264 V, 50/60 Hz (240 to 373 VDC *9)														
Permissible frequency fluctuation		±5%														
Power supply	Rated input current (A)*8	Without DC reactor	LD	1.9	3.0	5.1	8.2	12.5	16.1	25.5	37.1	48.6	74.3	90.5	112.9	139.5
			ND	1.4	2.3	4.5	7.0	10.7	15.0	23.1	30.5	41.0	63.6	79.9	99.0	114.3
		With DC reactor	LD	1.3	2.0	3.5	6.0	9.6	12.0	20.0	30.0	40.0	56.0	69.0	88.0	115.0
			ND	0.8	1.5	3.0	5.0	8.0	11.0	17.5	24.0	33.0	47.0	60.0	76.0	90.0
	Power supply capacity (kVA)*6	Without DC reactor	LD	0.7	1.1	1.9	3.1	4.8	6.2	9.7	15.0	19.0	29.0	35.0	43.0	54.0
			ND	0.5	0.9	1.7	2.7	4.1	5.7	8.8	12.0	16.0	25.0	31.0	38.0	44.0
		With DC reactor	LD	0.5	0.8	1.3	2.3	3.7	4.6	7.5	11.0	15.0	21.0	26.0	34.0	44.0
			ND	0.3	0.6	1.1	1.9	3.0	4.2	6.7	9.1	13.0	18.0	23.0	29.0	34.0
Protective structure (IEC 60529)		Open type (IP20)														
Cooling system		Natural						Forced air								
Approx. mass (kg)		0.5	0.5	0.7	1.0	1.4	1.4	1.8	3.3	3.3	5.4	5.6	11.0	11.0		

◆ Three-phase 400 V class

Model FR-E840-□		0016 0026 0040 0060 0095 0120 0170 0230 0300 0380 0440												
		0.4K 0.75K 1.5K 2.2K 3.7K 5.5K 7.5K 11K 15K 18.5K 22K												
Applicable motor capacity (kW)*1	LD	0.75	1.5	2.2	3.0	5.5	7.5	11.0	15.0	18.5	22.0	30.0		
	ND	0.4	0.75	1.5	2.2	3.7	5.5	7.5	11.0	15.0	18.5	22.0		
Rated capacity (kVA) *2	LD	1.6	2.7	4.2	5.3	8.5	13.3	17.5	26.7	31.2	34.3	45.7		
	ND	1.2	2.0	3.0	4.6	7.2	9.1	13.0	17.5	22.9	29.0	33.5		
Rated current (A) *7	LD	2.1 (1.8)	3.5 (3.0)	5.5 (4.7)	6.9 (5.9)	11.1 (9.4)	17.5 (14.9)	23.0 (19.6)	35.0 (29.8)	41.0 (34.9)	45.0 (38.3)	60.0 (51.0)		
	ND	1.6 (1.4)	2.6 (2.2)	4.0 (3.8)	6.0 (5.4)	9.5 (8.7)	12.0	17.0	23.0	30.0	38.0	44.0		
Overload current rating *3	LD	120% 60 s, 150% 3 s (inverse-time characteristics) at surrounding air temperature of 50°C												
	ND	150% 60 s, 200% 3 s (inverse-time characteristics) at surrounding air temperature of 50°C												
Voltage *4		Three-phase 380 to 480 V												
Regenerative braking	Brake transistor	Built-in												
	Maximum brake torque (ND reference) *5	100%			50%			20%						
Rated input AC (DC) voltage/frequency		Three-phase 380 to 480 V 50/60 Hz (537 to 679VDC *9)												
Permissible AC (DC) voltage fluctuation		323 to 528 V, 50/60 Hz (457 to 740VDC *9)												
Permissible frequency fluctuation		±5%												
Power supply	Rated input current (A) *8	Without DC reactor	LD	3.3	6.0	8.9	10.7	16.2	24.9	32.4	46.7	54.2	59.1	75.6
			ND	2.7	4.4	6.7	9.5	14.1	17.8	24.7	32.1	41.0	50.8	57.3
		With DC reactor	LD	2.1	3.5	5.5	6.9	11.0	18.0	23.0	35.0	41.0	45.0	60.0
			ND	1.6	2.6	4.0	6.0	9.5	12.0	17.0	23.0	30.0	38.0	44.0
	Power supply capacity (kVA) *6	Without DC reactor	LD	2.5	4.5	6.8	8.2	12.4	19.0	25.0	36.0	42.0	45.0	58.0
			ND	2.1	3.4	5.1	7.2	10.8	14.0	19.0	25.0	32.0	39.0	44.0
		With DC reactor	LD	1.6	2.7	4.2	5.3	8.5	13.0	18.0	27.0	31.0	34.0	46.0
			ND	1.2	2.0	3.0	4.6	7.2	9.1	13.0	18.0	23.0	29.0	34.0
Protective structure (IEC 60529)		Open type (IP20)												
Cooling system		Natural						Forced air						
Approx. mass (kg)		1.2	1.2	1.4	1.8	1.8	2.4	2.4	4.8	4.9	11.0	11.0		

- *1 The applicable motor capacity indicated is the maximum capacity applicable for use of the Mitsubishi Electric standard 4-pole motor.
To drive a Mitsubishi Electric high-performance energy-saving motor, use the 200 V class 0.75K inverter for a 1.1 kW motor, or 200/400 V class 2.2K inverter for a 3 kW motor.
- *2 The rated output capacity indicated assumes that the output voltage is 230 V for three-phase 200 V class and 440 V for three-phase 400 V class.
- *3 The % value of the overload current rating indicated is the ratio of the overload current to the inverter's rated output current. For repeated duty, allow time for the inverter and motor to return to or below the temperatures under 100% load.
- *4 The maximum output voltage does not exceed the power supply voltage. The maximum output voltage can be changed within the setting range. However, the pulse voltage value of the inverter output side voltage remains unchanged at about 1/2 that of the power supply.
- *5 The braking torque indicated is a short-duration average torque (which varies with motor loss) when the motor alone is decelerated from 60 Hz in the shortest time and is not a continuous regenerative torque. When the motor is decelerated from the frequency higher than the base frequency, the average deceleration torque will reduce. Since the inverter does not contain a brake resistor, use the optional brake resistor when regenerative energy is large. A brake unit (FR-BU2) may also be used. (Option brake resistor cannot be used for 0.1K and 0.2K.)
- *6 The power supply capacity varies with the value of the power supply side inverter impedance (including those of the input reactor and cables).
- *7 Setting 2 kHz or more in **Pr. 72 PWM frequency selection** to perform low acoustic noise operation in the surrounding air temperature exceeding 40°C, the rated output current is the value in parenthesis.
- *8 The rated input current is the value when at the rated output current. The input power impedances (including those of the input reactor and cables) affect the value.
- *9 • Connect the DC power supply to the inverter terminals P/+ and N/-. Connect the positive terminal of the power supply to terminal P/+ and the negative terminal to terminal N/-.
• When the energy is regenerated from the motor, the voltage between terminals P/+ and N/- may temporarily rise to 415 V or more. Use a DC power supply resistant to the regenerative voltage/energy. When a power supply that cannot resist the regenerative voltage/energy is used, connect a reverse current prevention diode in series.
• Powering ON produces up to four times as large current as the inverter rated current. Prepare a DC power supply resistant to the inrush current at power ON, although an inrush current limit circuit is provided in the FR-E800 series inverter.
• The power capacity depends on the output impedance of the power supply. Select a power capacity around the AC power supply capacity.

◆ Three-phase 575 V class

Model FR-E860-□				0017	0027	0040	0061	0090	0120		
				0.75K	1.5K	2.2K	3.7K	5.5K	7.5K		
Applicable motor capacity (kW) *1		LD		1.5	2.2	3.7	5.5	7.5	11.0		
		ND		0.75	1.5	2.2	3.7	5.5	7.5		
Output	Rated capacity (kVA) *2	LD		2.5	3.6	5.6	8.2	11.0	15.9		
		ND		1.7	2.7	4.0	6.1	9.0	12.0		
	Rated current (A) *7	LD		2.5 (2.1)	3.6 (3.0)	5.6 (4.8)	8.2 (7.0)	11.0 (9.0)	16.0 (13.6)		
		ND		1.7	2.7	4.0	6.1	9.0	12.0		
	Overload current rating *3	LD		120% 60 s, 150% 3 s (inverse-time characteristics) at surrounding air temperature of 50°C							
		ND		150% 60 s, 200% 3 s (inverse-time characteristics) at surrounding air temperature of 50°C							
	Voltage *4		Three-phase 525 to 600 V								
	Regenerative braking	Brake transistor	Built-in								
		Maximum brake torque (ND reference) *5	100%			50%			20%		
	Rated input AC voltage/frequency		Three-phase 575 V 60 Hz								
Permissible AC voltage fluctuation		490 to 632 V, 60 Hz									
Permissible frequency fluctuation		±5%									
Power supply	Rated input current (A) *8	Without DC reactor	LD	4.3	5.9	8.9	12.4	15.9	22.4		
			ND	3.0	4.6	6.6	9.5	13.3	17.4		
		With DC reactor	LD	2.5	3.6	5.6	8.2	11.0	16.0		
			ND	1.7	2.7	4.0	6.1	9.0	12.0		
	Power supply capacity (kVA) *6	Without DC reactor	LD	4.3	5.9	8.9	12.3	16.0	23.0		
			ND	3.0	4.6	6.6	9.5	14.0	18.0		
		With DC reactor	LD	2.5	3.6	5.6	8.2	11.0	16.0		
			ND	1.7	2.7	4.0	6.1	9.0	12.0		
Protective structure (IEC 60529)		Open type (IP20)									
Cooling system		Natural			Forced air						
Approx. mass (kg)		1.9		1.9	1.9	2.4	2.4	2.4	2.4		

*1 The motor capacity indicates the maximum capacity of a standard 4-pole motor driven by all of the inverters in parallel connection.

*2 The rated output capacity is the value with respect to 575 V output voltage.

*3 The percentage of the overload current rating is the ratio of the overload current to the inverter's rated output current. For repeated duty, allow time for the inverter and motor to return to or below the temperatures under 100% load.

*4 The maximum output voltage does not exceed the power supply voltage. The maximum output voltage can be changed within the setting range. The maximum point of the voltage waveform at the output side of the inverter is approximately the power supply voltage multiplied by $\sqrt{2}$.

*5 The amount of braking torque is the average short-term torque (which varies depending on motor loss) that is generated when a motor decelerates in the shortest time by itself from 60 Hz. It is not continuous regenerative torque. The average deceleration torque becomes lower when a motor decelerates from a frequency higher than the base frequency. The inverter is not equipped with a built-in brake resistor. Use a brake resistor for an operation with large regenerative power. A brake unit can be also used.

*6 The power supply capacity varies with the value of the input power impedance (including those of the input reactor and cables).

*7 The value in parentheses is the rated output current when the low acoustic noise operation is performed with the surrounding air temperature exceeding 40°C while 2 kHz or higher value is selected in **Pr. 72 PWM frequency selection**.

*8 The rated input current is the value at a rated output voltage. The input power impedances (including those of the input reactor and cables) affect the value.

◆ Single-phase 200 V class

Model FR-E820S-□			0008	0015	0030	0050	0080	0110	
			0.1K	0.2K	0.4K	0.75K	1.5K	2.2K	
Applicable motor capacity (kW)*1		ND	0.1	0.2	0.4	0.75	1.5	2.2	
Output	Rated capacity (kVA)*2	ND	0.3	0.6	1.2	2.0	3.2	4.4	
	Rated current (A)*7	ND	0.8 (0.8)	1.5 (1.4)	3.0 (2.5)	5.0 (4.1)	8.0 (7.0)	11.0 (10.0)	
	Overload current rating*3	ND	150% 60 s, 200% 3 s (inverse-time characteristics) at surrounding air temperature of 50°C						
	Voltage*4	Three-phase 200 to 240 V							
	Regenerative braking	Brake transistor	Not installed			Built-in			
Maximum brake torque (ND reference)*5		150%			100%		50%	20%	
Power supply	Rated input AC voltage/frequency		Single-phase 200 to 240 V 50/60 Hz						
	Permissible AC voltage fluctuation		170 to 264 V, 50/60 Hz						
	Permissible frequency fluctuation		±5%						
	Rated input current (A)*8	Without DC reactor	ND	2.3	4.1	7.9	11.2	17.9	25.0
		With DC reactor		1.4	2.6	5.2	8.7	13.9	19.1
	Power supply capacity (kVA)*6	Without DC reactor	ND	0.5	0.9	1.7	2.5	3.9	5.5
With DC reactor			0.3	0.6	1.1	1.9	3.0	4.2	
Protective structure (IEC 60529)			Open type (IP20)						
Cooling system			Natural					Forced air	
Approx. mass (kg)			0.5	0.5	0.8	1.3	1.4	1.9	

◆ Single-phase 100 V power supply

Model FR-E810W-□			0008	0015	0030	0050
			0.1K	0.2K	0.4K	0.75K
Applicable motor capacity (kW)*1		ND	0.1	0.2	0.4	0.75
Output	Rated capacity (kVA)*2	ND	0.3	0.6	1.2	2.0
	Rated current (A)*7	ND	0.8 (0.8)	1.5 (1.4)	3.0 (2.5)	5.0 (4.1)
	Overload current rating*3	ND	150% 60 s, 200% 3 s (inverse-time characteristics) at surrounding air temperature of 50°C			
	Voltage*9*10	Three-phase 200 to 240 V				
	Regenerative braking	Brake transistor	Not used			Built-in
Maximum brake torque*5		150%			100%	
Power supply	Rated input AC voltage/frequency		Single-phase 100 to 120 V, 50/60 Hz			
	Permissible AC voltage fluctuation		90 to 132 V, 50/60 Hz			
	Permissible frequency fluctuation		±5%			
	Rated input current (A)	ND	3.7	6.8	12.4	19.6
Protective structure (IEC 60529)			Open type (IP20)			
Cooling system			Natural			
Approx. mass (kg)			0.5	0.6	0.8	1.4

- *1 The motor capacity indicates the maximum capacity of a standard 4-pole motor driven by all of the inverters in parallel connection.
- *2 The rated output capacity indicated assumes that the output voltage is 230 V.
- *3 The % value of the overload current rating indicated is the ratio of the overload current to the inverter's rated output current. For repeated duty, allow time for the inverter and motor to return to or below the temperatures under 100% load. For single-phase power input model, the bus voltage decreases to power failure detection level and the load of 100% or higher may not be available if the automatic restart after instantaneous power failure function (Pr.57) or the power failure stop function (Pr.261) is set and power supply voltage is low while the load increases.
- *4 The maximum output voltage does not exceed the power supply voltage. The maximum output voltage can be changed within the setting range. However, the pulse voltage value of the inverter output side voltage remains unchanged at about $\sqrt{2}$ that of the power supply.
- *5 The amount of braking torque is the average short-term torque (which varies depending on motor loss) that is generated when a motor decelerates in the shortest time by itself from 60 Hz. It is not continuous regenerative torque. The average deceleration torque becomes lower when a motor decelerates from a frequency higher than the base frequency. The inverter is not equipped with a built-in brake resistor. Use a brake resistor for an operation with large regenerative power. (not available for FR-E820S-0008(0.1K), FR-E820S-0015(0.2K), FR-E810W-0008(0.1K), and FR-E810W-0015(0.2K).) A brake unit can be also used.
- *6 The power supply capacity varies with the value of the power supply side inverter impedance (including those of the input reactor and cables).
- *7 Setting 2 kHz or more in Pr. 72 PWM frequency selection to perform low acoustic noise operation in the surrounding air temperature exceeding 40°C, the rated output current is the value in parenthesis.
- *8 The rated input current indicates a value at a rated output voltage. The impedance at the power supply side (including those of the input reactor and cables) affects the rated input current.
- *9 For the single-phase 100 V power input models, the maximum output voltage is twice the amount of the power supply voltage.
- *10 For the single-phase 100 V power input models, output voltage decreases by applying motor load, and output current increases compared to the three-phase power input models. The load must be reduced so that output current does not exceed the rated motor current.

● Common specifications

Control specifications	Control method		Soft-PWM control/high carrier frequency PWM control
	Output frequency range	Induction motor	Selectable among V/F control, Advanced magnetic flux vector control, Real sensorless vector control, and Vector control*1
		PM motor	PM sensorless vector control
	Frequency setting resolution	Induction motor	0.2 to 590 Hz (The upper-limit frequency is 400 Hz under Advanced magnetic flux vector control, Real sensorless vector control, and Vector control*1.)
		PM motor	0.2 to 400 Hz (not operable at maximum motor frequency or higher)
	Frequency accuracy	Analog input	0.015 Hz /60 Hz at 0 to 10 V / 12 bits (terminals 2 and 4) 0.03 Hz /60 Hz at 0 to 5 V / 11 bits or 0 to 20 mA / 11 bits (terminals 2 and 4)
		Digital input	0.01 Hz
	Voltage/frequency characteristics		Base frequency can be set from 0 to 590 Hz. Constant-torque/variable torque pattern can be selected. (available with induction motors only)
	Starting torque	Induction motor	Advanced magnetic flux vector control: 150% at 0.5 Hz, Real sensorless vector control and Vector control*1: 200% at 0.3 Hz (0.1K to 3.7K), 150% at 0.3 Hz (5.5K or higher)
		PM motor	50%
	Torque boost		Manual torque boost (available with induction motors only)
	Acceleration/deceleration time setting		0 to 3600 s (acceleration and deceleration can be set individually), linear or S-pattern acceleration/deceleration mode
	DC injection brake	Induction motor	Operation frequency (0 to 120 Hz), operation time (0 to 10 s), operation voltage (0 to 30%) can be changed.
		PM motor	Operation time (0 to 10 s) can be changed, operation voltage (operating current) is fixed.
Stall prevention operation level		Operation current: 0 to 200% variable, with selectable availability of the function	
Torque limit level		Torque limit value can be set (0 to 400% variable). (Real sensorless vector control, Vector control*1, PM sensorless vector control)	
Operation specifications	Frequency setting signal	Analog input	Terminals 2 and 4: 0 to 10 V, 0 to 5 V, 4 to 20 mA (0 to 20 mA) are available.
		Digital input	Input using the operation panel. Four-digit BCD or 16-bit binary (when used with option FR-A8AX E kit)
	Start signal		Forward and reverse rotation or start signal automatic self-holding input (3-wire input) can be selected.
	Input signal (standard model: 7, Ethernet model: 2)		Low-speed operation command, Middle-speed operation command, High-speed operation command, Output stop, Forward rotation command, Reverse rotation command, Inverter reset The input signal can be changed using Pr.178 to Pr.189 (input terminal function selection) .
	Operational functions		Maximum and minimum frequency settings, multi-speed operation, acceleration/deceleration pattern, thermal protection, DC injection brake, starting frequency, JOG operation, output stop (MRS), stall prevention, regeneration avoidance, increased magnetic excitation deceleration, frequency jump, rotation display, automatic restart after instantaneous power failure, remote setting, automatic acceleration/deceleration, retry function, carrier frequency selection, fast-response current limit, forward/reverse rotation prevention, operation mode selection, slip compensation, droop control, speed smoothing control, traverse, auto tuning, applied motor selection, RS-485 communication*2, Ethernet communication*4, PID control, easy dancer control, cooling fan operation selection, stop selection (deceleration stop/coasting), power-failure deceleration stop function, stop-on-contact control, PLC function, life diagnosis, maintenance timer, current average monitor, multiple rating, orientation control*1, speed control, torque control, torque limit, position control, test operation, safety stop function, emergency drive*3, anti-sway control
	Output signal	Open collector output (standard model: 2) Relay output (1)	
		Analog output (AM type)	
	Protective/warning function	Protective functions	Overcurrent trip during acceleration, Overcurrent trip during constant speed, Overcurrent trip during deceleration or stop, Regenerative overvoltage trip during acceleration, Regenerative overvoltage trip during constant speed, Regenerative overvoltage trip during deceleration or stop, Inverter overload trip, Motor overload trip, Heat sink overheat, Undervoltage, Input phase loss*5, Stall prevention stop, Loss of synchronism detection*6, Upper limit fault detection, Lower limit fault detection, Brake transistor alarm detection, Output side earth (ground) fault overcurrent, Output short circuit, Output phase loss, External thermal relay operation, PTC thermistor operation*6, Option fault, Communication option fault, Internal storage device fault, Parameter storage device fault, PU disconnection, Retry count excess, CPU fault, Abnormal output current detection, Inrush current limit circuit fault, USB communication fault, analog input error, Safety circuit fault, Overspeed occurrence*6, Speed deviation excess detection*6, Excessive position fault*1*6, Brake sequence fault*6, Acceleration error*6, PID signal fault, Ethernet communication fault*4, Opposite rotation deceleration fault*6, Internal circuit fault, User definition error by the PLC function, Board combination mismatch
		Warning functions	Fan alarm, Stall prevention (overcurrent), Stall prevention (overvoltage), Regenerative brake pre-alarm*6, Electronic thermal relay function pre-alarm, PU stop, Maintenance timer warning, Parameter write error, Operation panel lock*6, Password locked, Speed limit indication, Stroke limit warning*6, Home position return setting error*6, Home position return uncompleted*6, Safety stop, load fault warning, emergency drive in operation*3*6, Ethernet communication fault*4, Duplicate IP address*4, IP address fault*4, Incorrect parameter setting, corrosion warning
	Environment	Surrounding air temperature	
Ambient humidity		95% RH or less (non-condensing) (With circuit board coating (conforming to IEC 60721-3-3: 1994 3C2)) 90% RH or less (non-condensing) (Without circuit board coating)	
Storage temperature*7		-40°C to +70°C	
Atmosphere		Indoors (without corrosive gas, flammable gas, oil mist, dust and dirt, etc.)	
Altitude/vibration*8		Maximum 3000 m (Maximum 2000 m for the 575 V class), 5.9 m/s ² or less at 10 to 55 Hz (directions of X, Y, Z axes)	

*1 Available when a Vector control compatible option (FR-A8AP E kit) is installed.

*2 Enabled only for standard models.

*3 Available for the standard model and the Ethernet model.

*4 Available for the Ethernet model and the safety communication model.

*5 Available for the three-phase power input model.

*6 This protective function is not available in the initial status.

*7 Temperature applicable for a short time, e.g. in transit.

*8 For installation at an altitude above 1000 m, consider a 3% reduction in the rated current per 500 m increase in altitude.

◆ PLC function specifications

The following table shows the program capacity and devices of the PLC function.

Item		E800 PLC function specifications	
Control method		Repeated operation (by stored program)	
I/O control mode		Refresh	
Programming language		Relay symbolic language (ladder) Logic symbolic language Function block Structured text (ST)	
No. of instructions	Sequence instructions	25	
	Basic instructions	88	
	Application instructions	37	
Processing speed		Sequence instructions 1.9 μ s to 12 μ s/step*1	
Number of I/O device points		288 (input: 144 points, output: 144 points) For FR-E800 series: 10 points built-in (input: 7 points, output: 3 points)*2 For FR-E800-E series: 3 points built-in (input: 2 points, output: 1 point)*2 For FR-E800-SCE series: 1 point built-in (output: 1 point)*2 FR-A8AX (input: 16 points) FR-A8AY (output: 7 points) FR-A8AR (output: 3 points)	
Number of analog I/O points		2 input points built-in (Terminals 2 and 4) 2 output points built-in (Terminals FM and AM), FR-A8AY: 2 output points (Terminals AM0 and AM1)	
Watchdog timer		10 to 2000 ms	
Program capacity		2K steps (8k bytes) (0 to 2048 steps can be set), contained in one program	
Device	Internal relay (M)		128 (M0 to M127)
	Latch relay (L)		Not used (Can be set with parameters but will not latch)*3
	Timer (T)	Number of points	16 (T0 to T15)
		Specifications	100 ms timer: 0.1 to 3276.7 s can be set 10 ms timer: 0.01 to 327.67 s can be set
	Retentive timer (ST)	Number of points	16 (ST0 to ST15)*5
		Specifications	100 ms retentive timer: 0.1 to 3276.7 s can be set 10 ms retentive timer: 0.01 to 327.67 s can be set
	Counter (C)	Number of points	16 (C0 to C15)
		Specifications	Normal counter: Setting range 1 to 32767 Interrupt program counter: Not used
	Data register (D)		256 (D0 to D255)
	Pointer (P)		256 points (P0 to P127, P2048 to P2175*4) (All are common pointers.)
Special relay (SM)		2048 (SM0 to SM2047) with limited functions	
Special register (SD)		2048 (SD0 to SD2047) with limited functions	

*1 The scan time is approximately 40 ms for 1K steps as inverter control is also performed in actual operations.

*2 The signals same as the ones assigned to the inverter I/O terminals are used. One point is always required for a sequence start (RUN/STOP).

*3 There is no device latch function for power failures. Use the **Pr.1150 to Pr.1199 PLC function user parameters 1 to 50** (D206 to D255) to store device values in the EEPROM.

*4 P2048 to P2175 are used for automatic assignment. For details of automatic assignment, refer to GX Works2 Operating Manual (Simple Project).

*5 The initial value is "0".

NOTE

- There is no buffer memory.

◆ Amount of heat generated by the inverter

When the heat sink is installed, the amount of heat generated by the inverter unit is shown in the following table.

Voltage	Inverter model	Amount of heat generated (W)*1			
		Standard model		Ethernet model / Safety communication model	
		LD	ND	LD	ND
Three-phase 200 V class	FR-E820-0008(0.1K)	16	11	17	12
	FR-E820-0015(0.2K)	21	16	22	17
	FR-E820-0030(0.4K)	35	29	36	30
	FR-E820-0050(0.75K)	61	48	62	49
	FR-E820-0080(1.5K)	91	74	92	75
	FR-E820-0110(2.2K)	107	91	108	92
	FR-E820-0175(3.7K)	177	153	178	154
	FR-E820-0240(5.5K)	251	191	252	192
	FR-E820-0330(7.5K)	317	249	318	250
	FR-E820-0470(11K)	426	341	427	342
	FR-E820-0600(15K)	547	414	548	415
	FR-E820-0760(18.5K)	735	600	736	601
	FR-E820-0900(22K)	1063	745	1064	746
Three-phase 400 V class	FR-E840-0016(0.4K)	33	25	34	26
	FR-E840-0026(0.75K)	55	38	56	39
	FR-E840-0040(1.5K)	84	58	85	59
	FR-E840-0060(2.2K)	88	75	89	76
	FR-E840-0095(3.7K)	136	112	137	113
	FR-E840-0120(5.5K)	223	136	224	137
	FR-E840-0170(7.5K)	299	197	300	198
	FR-E840-0230(11K)	410	239	411	240
	FR-E840-0300(15K)	486	321	487	322
	FR-E840-0380(18.5K)	510	348	511	349
	FR-E840-0440(22K)	589	401	590	402
Three-phase 575 V class	FR-E860-0017(0.75K)	39	32	40	33
	FR-E860-0027(1.5K)	48	38	49	39
	FR-E860-0040(2.2K)	71	52	72	53
	FR-E860-0061(3.7K)	103	76	104	77
	FR-E860-0090(5.5K)	128	103	129	104
	FR-E860-0120(7.5K)	178	127	179	128
Single-phase 200 V class	FR-E820S-0008(0.1K)	-	11	-	12
	FR-E820S-0015(0.2K)	-	17	-	18
	FR-E820S-0030(0.4K)	-	32	-	33
	FR-E820S-0050(0.75K)	-	49	-	50
	FR-E820S-0080(1.5K)	-	80	-	81
	FR-E820S-0110(2.2K)	-	95	-	96
Single-phase 100 V class	FR-E810W-0008(0.1K)	-	11	-	12
	FR-E810W-0015(0.2K)	-	17	-	18
	FR-E810W-0030(0.4K)	-	29	-	30
	FR-E810W-0050(0.75K)	-	47	-	48

*1 Inverter specifications are as follows.

Output current: inverter rated current

Power supply voltage: 110 V for the 100 V class, 220 V for the 200 V class, 440 V for the 400 V class, and 575 V for the 575 V class

Carrier frequency: 1 kHz

Outline Dimensions

- FR-E820-0.1K to 0.75K
- FR-E820S-0.1K to 0.4K
- FR-E810W-0.1K to 0.4K

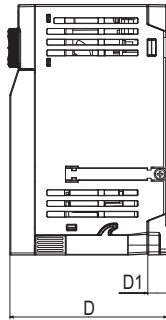
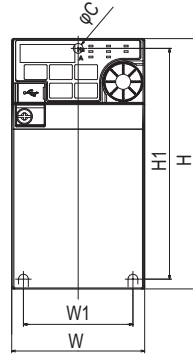

When used with the plug-in option

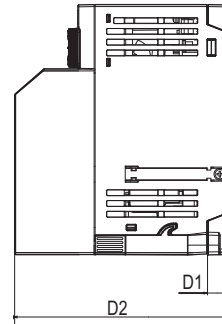

- FR-E820-1.5K to 22K
- FR-E840-0.4K to 22K
- FR-E860-0.75K to 7.5K
- FR-E820S-0.75K to 2.2K
- FR-E810W-0.75K

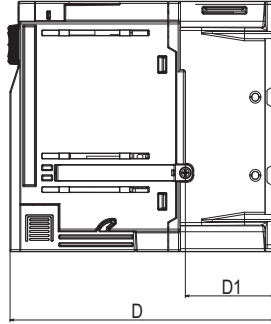
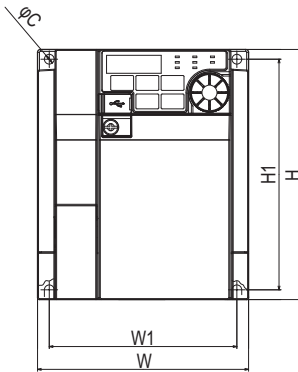

When used with the plug-in option

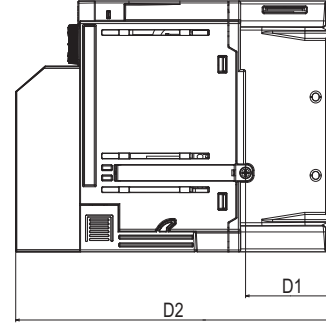

• Three-phase 200 V class

Inverter model	W	W1	H	H1	D	D1	D2	C
FR-E820-0.1K	68	56	128	118	80.5	10	108.1	5
FR-E820-0.2K					112.5	42	140.1	
FR-E820-0.4K					132.5	42	160.1	
FR-E820-0.75K					135.5	46	163.1	
FR-E820-1.5K	108	96	260	244	142.5	52.5	170.1	6
FR-E820-2.2K	140	128			165	71.5	192.6	
FR-E820-3.7K	180	164			190	84.7	217.6	
FR-E820-5.5K	220	195			330			
FR-E820-7.5K	220	200	350	330				10
FR-E820-11K								
FR-E820-15K								
FR-E820-18.5K								
FR-E820-22K								

• Three-phase 575 V class

Inverter model	W	W1	H	H1	D	D1	D2	C
FR-E860-0.75K	140	128	150	138	135	43.5	162.6	5
FR-E860-1.5K					147	68	174.6	
FR-E860-2.2K								
FR-E860-3.7K	220	208	150	138	147	68	174.6	5
FR-E860-5.5K								
FR-E860-7.5K								

• Single-phase 200 V class

Inverter model	W	W1	H	H1	D	D1	D2	C
FR-E820S-0.1K	68	56	128	118	80.5	10	108.1	5
FR-E820S-0.2K					142.5	42	170.1	
FR-E820S-0.4K					135	45.5	162.6	
FR-E820S-0.75K	108	96	128	118	161	46	188.6	5
FR-E820S-1.5K					142.5	52.5	170.1	
FR-E820S-2.2K								

• Three-phase 400 V class

Inverter model	W	W1	H	H1	D	D1	D2	C
FR-E840-0.4K	108	96	128	118	129.5	40	157.1	5
FR-E840-0.75K					46	162.6		
FR-E840-1.5K					135	43.5	162.6	
FR-E840-2.2K	140	128	150	138	135	43.5	162.6	5
FR-E840-3.7K	220	208	150	138	147	68	174.6	6
FR-E840-5.5K								
FR-E840-7.5K								
FR-E840-11K								
FR-E840-15K	220	195	260	244	190	84.7	217.6	10
FR-E840-18.5K								
FR-E840-22K								

• Single-phase 100 V class

Inverter model	W	W1	H	H1	D	D1	D2	C
FR-E810W-0.1K	68	56	128	118	80.5	10	108.1	5
FR-E810W-0.2K					110.5	42	138.1	
FR-E810W-0.4K					142.5	42	170.1	
FR-E810W-0.75K	108	96	150	138	155	40	182.6	5

The dimensions are the same among the standard model (FR-E800), Ethernet model (FR-E800-E), and safety communication model (FR-E800-SCE).
(Unit: mm)

MEMO

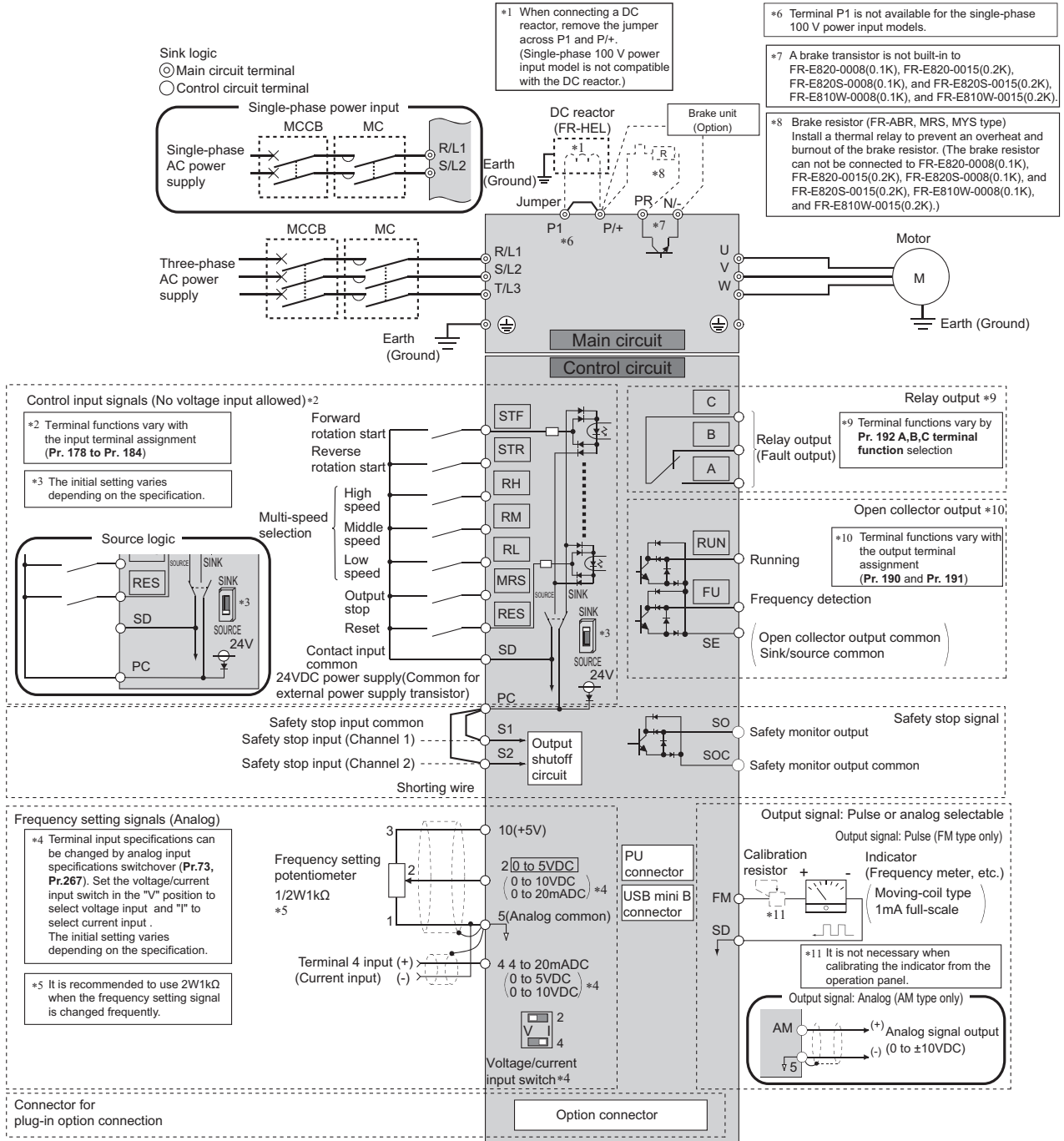

Type	Terminal Symbol	Common	Terminal Name	Description			
Main circuit	R/L1, S/L2, T/L3*1	—	AC power input	Connect to the commercial power supply. Do not connect anything to these terminals when using the high power factor converter (FR-HC2) or the multifunction regeneration converter (FR-XC) in common bus regeneration mode.			
	U, V, W	—	Inverter output	Connect a three-phase squirrel-cage motor or PM motor.			
	P/+, PR	—	Brake resistor connection	Connect a brake transistor (MRS type, MYS type, FR-ABR) across terminals P/+ - PR. (Not available for FR-E820-0008(0.1K), FR-E820-0015(0.2K), FR-E820S-0008(0.1K), FR-E820S-0015(0.2K), FR-E810W-0008(0.1K), and FR-E810W-0015(0.2K).)			
	P/+, N/-	—	Brake unit connection	Connect the brake unit (FR-BU2), multifunction regeneration converter (FR-XC), or high power factor converter (FR-HC2).			
	P/+, P1*2	—	DC reactor connection	Remove the jumper across terminals P/+ - P1 and connect a DC reactor. (Not applicable for the single-phase 100 V power input models.) When a DC reactor is not connected, the jumper across terminals P/+ and P1 should not be removed.			
		—	Earth (Ground)	For earthing (grounding) the inverter chassis. Must be earthed (grounded).			
input signal	Contact input	SD (sink (negative common)) PC (source (positive common))	STF*3	Forward rotation start	Turn on the STF signal to start forward rotation and turn it off to stop.	Input resistance: 4.7 kΩ, voltage when contacts are open: 21 to 26 VDC, current when contacts are short-circuited: 4 to 6 mADC	
			STR*3	Reverse rotation start	Turn on the STR signal to start reverse rotation and turn it off to stop.		When the STF and STR signals are turned on simultaneously, the stop command is given.
			RH, RM, RL*3	Multi-speed selection	Multi-speed can be selected according to the combination of RH, RM and RL signals.		
			MRS*3	Output stop	Turn ON the MRS signal (2 ms or more) to stop the inverter output. Use to shut off the inverter output when stopping the motor by electromagnetic brake.		
			RES*3	Reset	Use to reset alarm output provided when protective circuit is activated. Turn on the RES signal for more than 0.1s, then turn it off. It is possible to set the initial setting to "always enabled". By setting Pr. 75, reset can be set enabled only at fault occurrence. Recover about 1s after reset is cancelled.		
	Frequency setting	10	5	Frequency setting power supply	Used as power supply when connecting potentiometer for frequency setting (speed setting) from outside of the inverter.	5 VDC ± 0.5 V permissible load current 10 mA	
		2	5	Frequency setting (voltage)	Inputting 0 to 5 VDC (or 0 to 10 VDC) provides the maximum output frequency at 5 V (or 10 V) and makes input and output proportional. Use Pr.73 to switch between input 0 to 5 VDC (initial setting) and 0 to 10 VDC input (The initial setting varies depending on the specification). Set the voltage/current input switch to the "I" position to select current input (0 to 20 mA).	Voltage input: Input resistance 10 kΩ ± 1 kΩ Permissible maximum voltage 20 VDC Current input: Input resistance 245 Ω ± 5 Ω Maximum permissible current 30 mA.	
		4	5	Frequency setting (current)	Inputting 4 to 20 mADC (or 0 to 5 VDC, 0 to 10 VDC) provides the maximum output frequency at 20 mA and makes input and output proportional. This input signal is valid only when the AU signal is ON (terminal 2 input is invalid). To use the terminal 4 (current input at initial setting), assign "4" to any parameter from Pr.178 to Pr.184 (Input terminal function selection) before turning ON the AU signal (The initial setting varies depending on the specification). Use Pr.267 to switch among input 4 to 20 mA (initial setting), 0 to 5 VDC, and 0 to 10 VDC. Set the voltage/current input switch in the "V" position to select voltage input (0 to 5 V / 0 to 10 V).		
	output signal	Relay	—	A, B, C	Relay output (fault output)		1 changeover contact output indicates that the inverter fault occurs. Fault: discontinuity across B-C (continuity across A-C), Normal: continuity across B-C (discontinuity across A-C)
		Pulse/Open collector	RUN	SE	Inverter running	The output is in LOW state when the inverter output frequency is equal to or higher than the starting frequency (initial value: 0.5 Hz). The output is in HIGH state during stop or DC injection brake operation.*4	Permissible load 24 VDC (Maximum 27 VDC) 0.1 A (a voltage drop is 3.4 V maximum when the signal is on)
FU			SE	Frequency detection	The output is in LOW state when the inverter output frequency is equal to or higher than the preset detection frequency, and is in HIGH state when it is less than the preset detection frequency.*4		
FM*5			SD	For meter	Select one e.g. output frequency from monitor items. (Not output during inverter reset.) The output signal is proportional to the magnitude of the corresponding monitoring item.		
AM*5			5	Analog voltage output	Output item: output frequency (initial setting)		
Safety stop signal	S1	PC	Safety stop input (Channel 1)	Terminals S1 and S2 are used for the safety stop input signal for the safety relay module. Terminals S1 and S2 are used at the same time (dual channel). Inverter output is shutdown by shortening/opening between terminals S1 and SIC, or between S2 and SIC. In the initial status, terminals S1 and S2 are shorted with terminal PC by shorting wires. Terminal SIC is shorted with terminal SD. Remove the shorting wires and connect the safety relay module when using the safety stop function.	Input resistance 4.7 kΩ Voltage when contacts are open 21 to 26 VDC Current when contacts are short-circuited 4 to 6 mADC		
	S2	PC	Safety stop input (with 24 VDC input) (Channel 2)	Indicates the safety stop input signal status. Switched to LOW when the status is other than the internal safety circuit failure. Refer to the FR-E800 Instruction Manual (Functional Safety) (BCN-A23488-000) when the signal is switched to HIGH while both terminals S1 and S2 are open. (Please contact your sales representative for the manual.)			
	SO	SOC	Safety monitor output (open collector output)	Permissible load 24 VDC (maximum 27 VDC) 0.1 A (The voltage drop is 3.4 V at maximum while the signal is ON.)			

Type	Terminal Symbol	Common	Terminal Name	Description	
Common terminal	SD	—	Contact input common (sink (negative common))	Common terminal for contact input terminal (sink logic) and terminal FM.	
			External transistor common (source (positive common))	Connect this terminal to the power supply common terminal of a transistor output (open collector output) device, such as a programmable controller, in the source logic to avoid malfunction by undesirable currents.	
			24VDC power supply common	Common output terminal for 24VDC 0.1A power supply (PC terminal). Isolated from terminals 5 and SE.	
	PC	—	External transistor common (sink (negative common))	Connect this terminal to the power supply common terminal of a transistor output (open collector output) device, such as a programmable controller, in the sink logic to avoid malfunction by undesirable currents.	Power supply voltage range: 22 to 26.5 VDC, permissible load current: 100 mA
			Safety stop input terminal common	Common terminal for safety stop input terminals.	
			Contact input common (source (positive common))	Common terminal for contact input terminal (source logic).	
	5	—	SD	24VDC power supply	Can be used as 24 VDC 0.1 A power supply.
	SE	—	Frequency setting common	Common terminal for frequency setting signal (terminal 2 or 4) and terminal AM. Do not earth (ground).	
	SOC	—	Open collector output common	Common terminal of terminal RUN and FU.	
		—	Safety monitor output terminal common	Common terminal for terminal SO.	
Communication	—	—	PU connector	With the PU connector, RS-485 communication can be made. · Conforming standard: EIA-485 (RS-485) · Transmission format: Multi-drop link · Communication speed: 300 to 115200bps · Overall extension: 500m	
	—	—	USB connector*6	USB connection with a personal computer can be established. Setting, monitoring and testing of the inverter can be performed using FR Configurator2. · Interface: conforms to USB 1.1 · Transmission Speed: 12 Mbps · Connector: USB mini B connector (receptacle mini B type)	

- *1 Terminal T/L3 is not available for the single-phase power input models.
- *2 Terminal P1 is not available for the single-phase 100 V power input models.
- *3 Terminal functions can be selected using **Pr.178 to Pr.184 (Input terminal function selection)**.
- *4 An open collector transistor is ON (conductive) in LOW state. The transistor is OFF (not conductive) in HIGH state.
- *5 Terminal FM is provided for the FM type inverter. Terminal AM is provided for the AM type inverter.
- *6 USB bus power connection is available. The maximum SCCR is 500 mA. A PU connector cannot be used during USB bus power connection.

Terminal Connection Diagram

E800-E

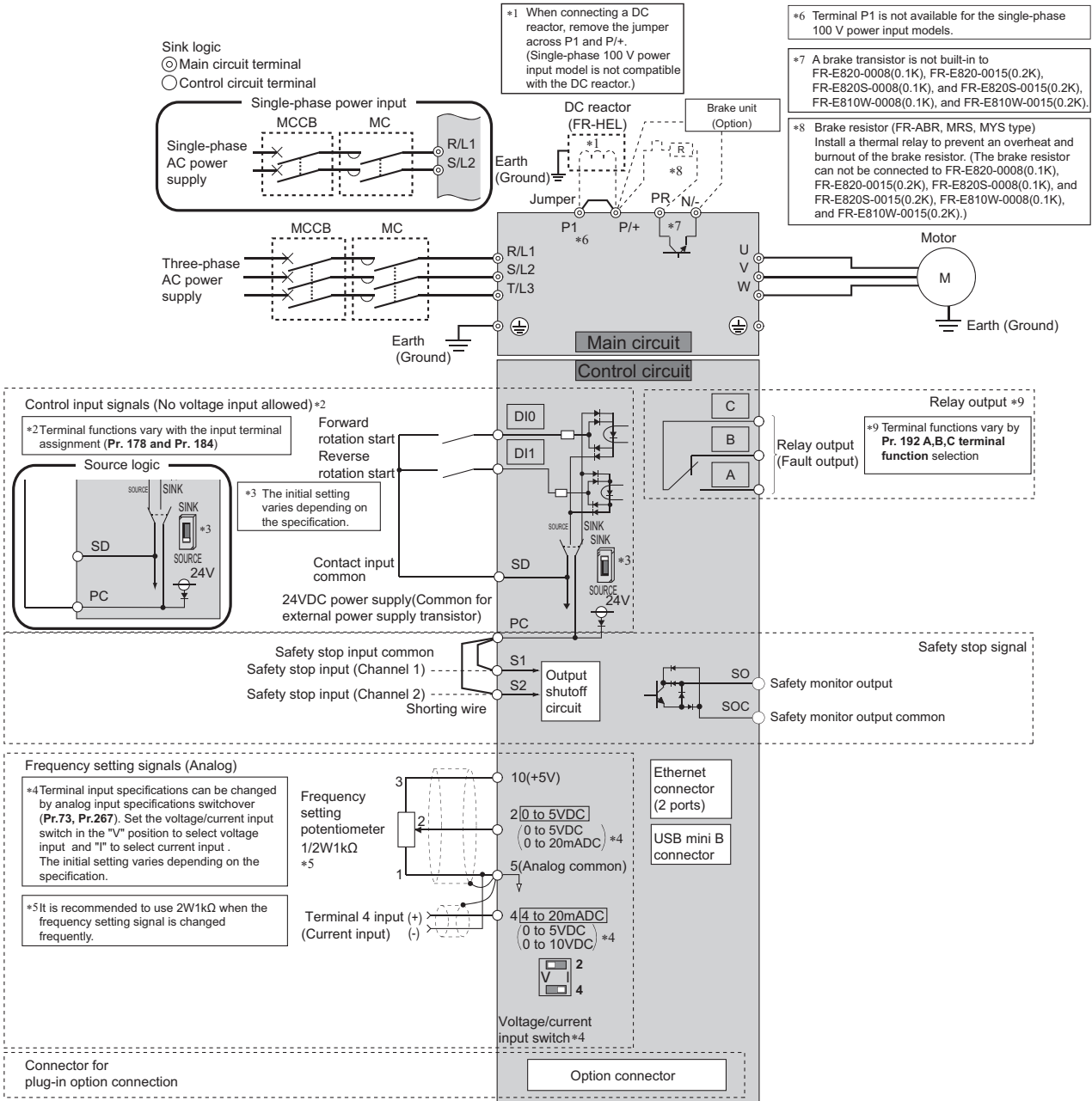

6

Terminal Connection Diagram, Terminal Specifications

Terminal Specifications E800-E

Type	Terminal Symbol	Common	Terminal Name	Description			
Main circuit	R/L1, S/L2, T/L3*1	—	AC power input	Connect to the commercial power supply. Do not connect anything to these terminals when using the high power factor converter (FR-HC2) or the multifunction regeneration converter (FR-XC) in common bus regeneration mode.			
	U, V, W	—	Inverter output	Connect a three-phase squirrel-cage motor or PM motor.			
	P/+, PR	—	Brake resistor connection	Connect a brake transistor (MRS type, MYS type, FR-ABR) across terminals P/+-PR. (Not available for FR-E820-0008(0.1K), FR-E820-0015(0.2K), FR-E820S-0008(0.1K), FR-E820S-0015(0.2K), FR-E810W-0008(0.1K), and FR-E810W-0015(0.2K).)			
	P/+, N/-	—	Brake unit connection	Connect the brake unit (FR-BU2), multifunction regeneration converter (FR-XC), or high power factor converter (FR-HC2).			
	P/+, P1*2	—	DC reactor connection	Remove the jumper across terminals P/+-P1 and connect a DC reactor. (Not applicable for the single-phase 100 V power input models.) When a DC reactor is not connected, the jumper across terminals P/+ and P1 should not be removed.			
		—	Earth (Ground)	For earthing (grounding) the inverter chassis. Must be earthed (grounded).			
input signal	Contact input	DI0*3	SD (sink (negative common))	Forward rotation start	Turn on the DI0 signal to start forward rotation and turn it off to stop.	When the DI0 and DI1 signals are turned on simultaneously, the stop command is given.	Input resistance: 4.7 kΩ, voltage when contacts are open: 21 to 26 VDC, current when contacts are short-circuited: 4 to 6 mADC
		DI1*3	PC (source (positive common))	Reverse rotation start	Turn on the DI1 signal to start reverse rotation and turn it off to stop.		
	Frequency setting	10	5	Frequency setting power supply	Used as power supply when connecting potentiometer for frequency setting (speed setting) from outside of the inverter.	5 VDC ± 0.5 V permissible load current 10 mA	
		2	5	Frequency setting (voltage)	Inputting 0 to 5 VDC (or 0 to 10 V) provides the maximum output frequency at 5 V (10 V) and makes input and output proportional. Use Pr. 73 to switch between input 0 to 5 VDC (initial setting) and 0 to 10 VDC input (The initial setting varies depending on the specification). Set the voltage/current input switch to the "I" position to select current input (0 to 20 mA).	Voltage input: Input resistance 10 kΩ ± 1 kΩ Permissible maximum voltage 20 VDC Current input: Input resistance 245 Ω ± 5 Ω Maximum permissible current 30 mA.	
4	5	Frequency setting (current)	Inputting 0 to 20 mADC (or 0 to 5 V / 0 to 10 V) provides the maximum output frequency at 20 mA makes input and output proportional. This input signal is valid only when the AU signal is on (terminal 2 input is invalid). To use terminal 4 (initial setting is current input), set "4" to any of Pr.178, Pr.179 (input terminal function selection), and turn AU signal ON (The initial setting varies depending on the specification). Use Pr. 267 to switch from among input 4 to 20 mA (initial setting), 0 to 5 VDC and 0 to 10 VDC. Set the voltage/current input switch in the "V" position to select voltage input (0 to 5 V / 0 to 10 V).				
output signal	Relay	A, B, C	—	Relay output (fault output)	1 changeover contact output indicates that the inverter fault occurs. Fault: discontinuity across B-C (continuity across A-C) Normal: continuity across B-C (discontinuity across A-C)	Contact capacity 240 VAC 2 A (power factor = 0.4) 30 VDC 1 A	
Safety stop signal	S1	PC	Safety stop input (Channel 1)	Terminals S1 and S2 are used for the safety stop input signal for the safety relay module. Terminals S1 and S2 are used at the same time (dual channel). Inverter output is shutdown by shortening/opening between terminals S1 and SIC, or between S2 and SIC. In the initial status, terminals S1 and S2 are shorted with terminal PC by shorting wires. Terminal SIC is shorted with terminal SD. Remove the shorting wires and connect the safety relay module when using the safety stop function.	Input resistance 4.7 kΩ Voltage when contacts are open 21 to 26 VDC Current when contacts are short-circuited 4 to 6 mADC		
	S2	PC	Safety stop input (with 24 VDC input) (Channel 2)				
	SO	SOC	Safety monitor output (open collector output)	Indicates the safety stop input signal status. Switched to LOW when the status is other than the internal safety circuit failure. Switched to HIGH during the internal safety circuit failure status. (LOW is when the open collector output transistor is ON (conducted). HIGH is when the transistor is OFF (not conducted).) Refer to the FR-E800 Instruction Manual (Functional Safety) (BCN-A23488-000) when the signal is switched to HIGH while both terminals S1 and S2 are open. (Please contact your sales representative for the manual.)	Permissible load 24 VDC (maximum 27 VDC) 0.1 A (The voltage drop is 3.4 V at maximum while the signal is ON.)		
Common terminal	SD	—	Contact input common (sink (negative common))	Common terminal for contact input terminal (sink logic).			
		—	External transistor common (source (positive common))	Connect this terminal to the power supply common terminal of a transistor output (open collector output) device, such as a programmable controller, in the source logic to avoid malfunction by undesirable current.			
		—	24 VDC power supply common	Common output terminal for 24 VDC 0.1 A power supply (PC terminal). Isolated from terminals 5 and SE.			
	PC	—	External transistor common (sink (negative common))	Connect this terminal to the power supply common terminal of a transistor output (open collector output) device, such as a programmable controller, in the sink logic to avoid malfunction by undesirable current.	Power supply voltage range: 22 to 26.5 VDC, permissible load current: 100 mA		
		—	Safety stop input terminal common	Common terminal for safety stop input terminals.			
		—	Contact input common (source (positive common))	Common terminal for the contact input terminal (source logic).			
5	—	24 VDC power supply	Can be used as 24 VDC 0.1 A power supply.				
5	—	Frequency setting common	Common terminal for the frequency setting signals (terminals 2 or 4). Do not earth (ground).				
SOC	—	Safety monitor output terminal common	Common terminal for terminal SO.				
Communication	—	—	Ethernet connector (2-port) *4	<ul style="list-style-type: none"> · Communication can be made via Ethernet. · Category: 100BASE-TX/10BASE-T · Data transmission speed: 100 Mbps (100BASE-TX) / 10 Mbps (10BASE-T) · Transmission method: Baseband · Maximum segment length: 100m between the hub and the inverter · Number of cascade connection stages: Up to 2 (100BASE-TX) / up to 4 (10BASE-T) · Interface: RJ-45 · Number of interfaces available: 2 · IP version: IPv4 			
	—	—	USB connector *5	<ul style="list-style-type: none"> · USB connection with a personal computer can be established. Setting, monitoring and testing of the inverter can be performed using FR Configurator2. · Interface: conforms to USB 1.1 · Transmission Speed: 12 Mbps · Connector: USB mini B connector (receptacle mini B type) 			

*1 Terminal T/L3 is not available for the single-phase power input models.
 *2 Terminal P1 is not available for the single-phase 100 V power input models.
 *3 Terminal functions can be selected using Pr.178, Pr.179 (Input terminal function selection).
 *4 Do not connect the parameter unit. The inverter may be damaged.
 *5 USB bus power connection is available. The maximum SCCR should be 500 mA.

Terminal Connection Diagram E800-SCE

Source logic
 ⊕ Main circuit terminal
 ○ Control circuit terminal

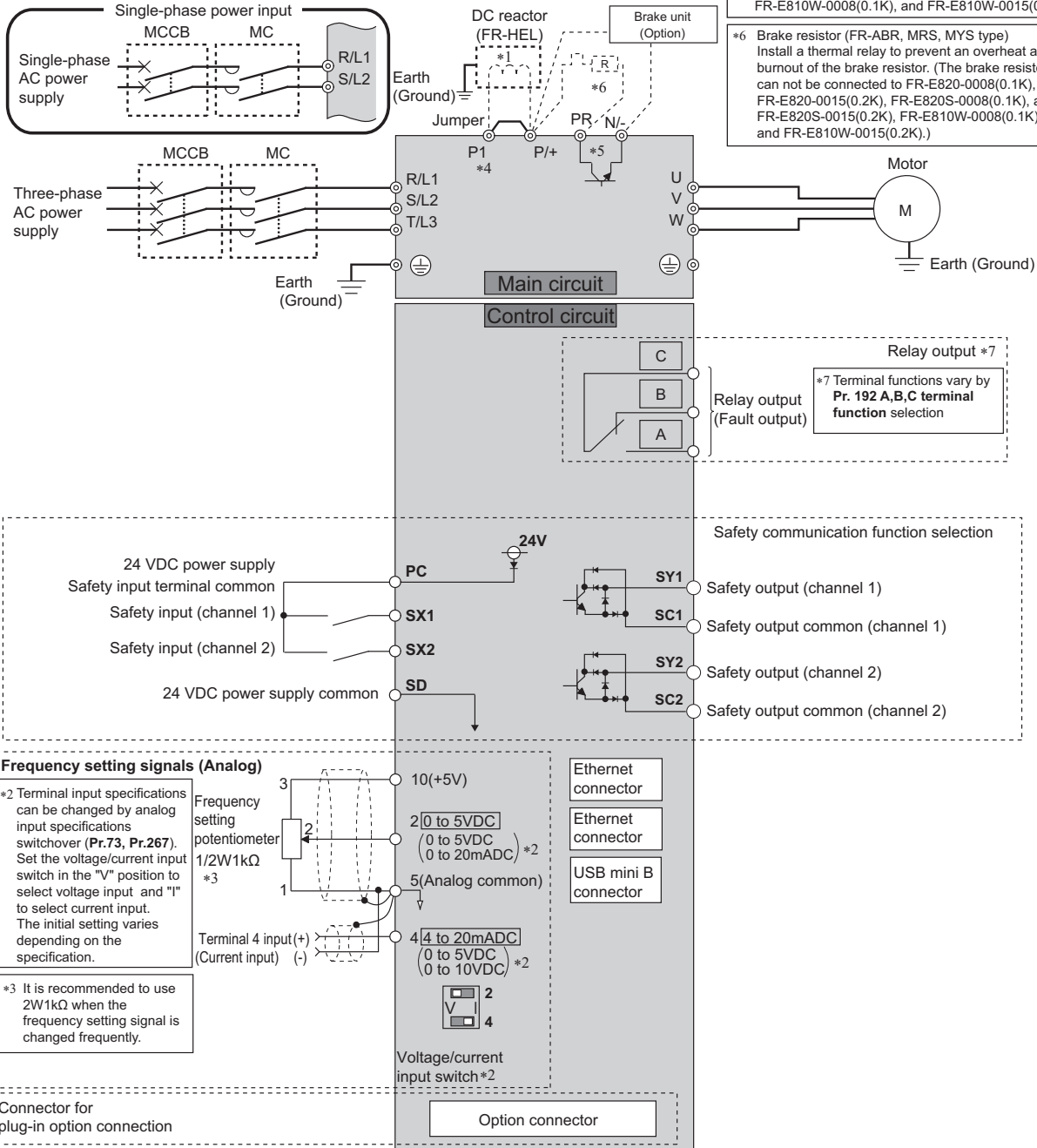

6

Terminal Connection Diagram, Terminal Specifications

Type	Terminal Symbol	Common	Terminal Name	Description	
Main circuit	R/L1, S/L2, T/L3*1	—	AC power input	Connected to the commercial power supply.	
	U, V, W	—	Inverter output	Connect a three-phase squirrel-cage motor or PM motor.	
	P/+, PR	—	Brake resistor connection	Connect an optional brake transistor (MRS, MYS, FR-ABR) between terminal P/+ and PR. (Not available for FR-E820-0008(0.1K), FR-E820-0015(0.2K), FR-E820S-0008(0.1K), FR-E820S-0015(0.2K), FR-E810W-0008(0.1K), and FR-E810W-0015(0.2K).)	
	P/+, N/-	—	Brake unit connection	Connect the brake unit (FR-BU2, FR-BU, or BU) or the multifunction regeneration converter (FR-XC in power regeneration mode) to these terminals.	
	P/+, P1*2	—	DC reactor connection	Remove the jumper across terminals P/+ and P1, and connect a DC reactor. (Not applicable for the single-phase 100 V power input models.) When a DC reactor is not connected, the jumper across terminals P/+ and P1 should not be removed.	
		—	Earth (Ground)	For earthing (grounding) the inverter chassis. Be sure to earth (ground) the inverter.	
input signal Frequency setting	10	5	Frequency setting power supply	Used as the power supply for an external frequency setting (speed setting) potentiometer. 5 ±0.5 VDC, Permissible load current: 10 mA	
	2	5	Frequency setting (voltage)	Inputting 0 to 5 VDC (or 0 to 10 VDC) provides the maximum output frequency at 5 V (or 10 V) and makes input and output proportional. Use Pr.73 to switch among input 0 to 5 VDC (initial setting), 0 to 10 VDC, and 0 to 20 mA. * The initial setting varies depending on the specification. Set the voltage/current input switch to the "I" position to select current input (0 to 20 mA). For voltage input, Input resistance: 10 ±1 kΩ	
	4	5	Frequency setting (current)	Inputting 4 to 20 mADC (or 0 to 5 VDC, 0 to 10 VDC) provides the maximum output frequency at 20 mA and makes input and output proportional. This input signal is valid only when the AU signal is ON (terminal 2 input is invalid). To use terminal 4 (current input at initial setting), assign "4" to Pr.178 or Pr.189 (Input terminal function selection) before turning ON the AU signal. * The initial setting varies depending on the specification. Use Pr.267 to switch among input 4 to 20 mA (initial setting), 0 to 5 VDC, and 0 to 10 VDC. Set the voltage/current input switch in the "V" position to select voltage input (0 to 5 V / 0 to 10 V). Maximum permissible voltage: 20 VDC For current input, Input resistance: 245 ±5 Ω Permissible maximum current: 30 mA	
output signal Relay	A, B, C	—	Relay output (fault output)	1 changeover contact output indicates that the inverter protective function has activated and the outputs are stopped. Fault: discontinuity across B and C (continuity across A and C), Normal: continuity across B and C (discontinuity across A and C) Contact capacity: 240 VAC 2A (power factor = 0.4) or 30 VDC 1 A	
Safety stop signal	SX1	PC	Safety input (channel 1)	Terminal functions can be selected using Pr.S051 SX1/SX2 terminal function selection . For details, refer to the FR-E800-SCE Instruction Manual (Functional Safety).	
	SX2	PC	Safety input (channel 2)		
	SY1	SC1	Safety output (channel 1)	Terminal functions can be selected using Pr.S055 SY1/SY2 terminal function selection . For details, refer to the FR-E800-SCE Instruction Manual (Functional Safety).	
	SY2	SC2	Safety output (channel 2)		
Common terminal	SD	—	24 VDC power supply common	Common output terminal for 24 VDC 0.1A power supply (terminal PC). Isolated from terminal 5.	
		—	External transistor common (source (positive common))		
	PC	—	Safety input terminal common	Common terminal for terminals SX1 and SX2.	Power supply voltage range: 22 to 26.5 VDC Permissible load current: 100 mA
		SD	24 VDC power supply	Can be used as a 24 VDC 0.1 A power supply.	
	5	—	Frequency setting common	Common terminal for the frequency setting signal (terminal 2 or 4). Do not earth (ground).	
	SC1	—	Safety output common (channel 1)	For details, refer to the FR-E800-SCE Instruction Manual (Functional Safety).	
	SC2	—	Safety output common (channel 2)		
Communication	—	—	Ethernet connector (2-port) *3	Communication can be made via Ethernet. · Category: 100BASE-TX/10BASE-T · Transmission method: Baseband · Data transmission speed: 100 Mbps (100BASE-TX) / 10 Mbps (10BASE-T) · Maximum segment length: 100 m between the hub and the inverter · Interface: RJ-45 · Number of cascade connection stages: Up to 2 (100BASE-TX) / up to 4 (10BASE-T) · Number of interfaces available: 2 · IP version: IPv4	
	—	—	USB connector *4	By connecting an inverter to the personal computer through USB, FR Configurator2 can be used for setting the inverter and monitoring the operation. · Interface: conforms to USB 1.1 · Transmission speed: 12 Mbps · Connector: USB mini B connector (receptacle mini B type)	

*1 Terminal T/L3 is not available for the single-phase power input models.
 *2 Terminal P1 is not available for the single-phase 100 V power input models.
 *3 Do not connect the parameter unit. The inverter may be damaged.
 *4 USB bus power connection is available. The maximum SCCR should be 500 mA.

Example Connections

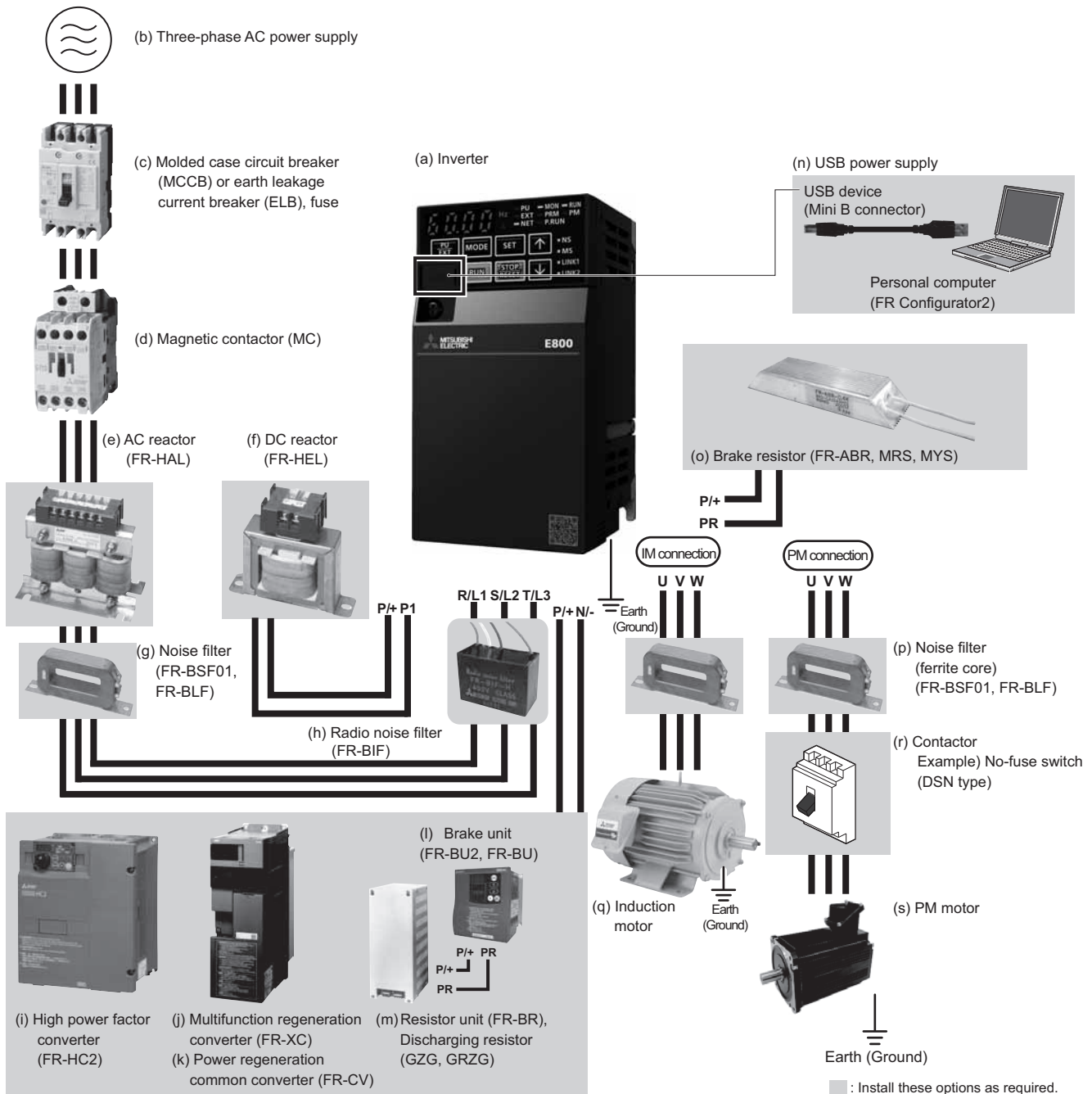

7

Example Connections

Symbol	Name	Overview
(a)	Inverter (FR-E800)	The life of the inverter is influenced by the surrounding air temperature. The surrounding air temperature should be as low as possible within the permissible range. This must be noted especially when the inverter is installed in an enclosure. Incorrect wiring may lead to damage of the inverter. The control signal lines must be kept fully away from the main circuit lines to protect them from noise.
(b)	Three-phase AC power supply	Must be within the permissible power supply specifications of the inverter.
(c)	Molded case circuit breaker (MCCB), earth leakage circuit breaker (ELB), or fuse	Must be selected carefully since an inrush current flows in the inverter at power ON.
(d)	Magnetic contactor (MC)	Install this to ensure safety. Do not use this to start and stop the inverter. Doing so will shorten the life of the inverter.
(e)	AC reactor (FR-HAL)	Install this to suppress harmonics and to improve the power factor. An AC reactor (FR-HAL) (option) is required when installing the inverter near a large power supply system (500 kVA or more). Under such condition, the inverter may be damaged if you do not use a reactor. Select a reactor according to the applied motor capacity. (When using a motor with capacity lower than 0.4 kW, select the reactor for a 0.4kW motor. For the single-phase 200 V power input models, select the reactor whose capacity is one rank higher than the motor capacity. For the single-phase 100 V power input models, select the reactor whose capacity is three ranks higher than the motor capacity.)
(f)	DC reactor (FR-HEL)	Install this to suppress harmonics and to improve the power factor. Select a reactor according to the applied motor capacity. When using a DC reactor, remove the jumper across terminals P/+ and P1 before connecting a DC reactor to the inverter. A DC reactor (FR-HEL) cannot be connected to the single-phase 100 V power input models.
(g)	Noise filter (ferrite core) (FR-BSF01, FRBLF)	Install this to reduce the electromagnetic noise generated from the inverter.
(h)	Radio noise filter (FR-BIF)	Install this to reduce the radio noise.
(i)	High power factor converter (FR-HC2)	Suppresses the power supply harmonics significantly. Install this as required.*1
(j)	Multifunction regeneration converter (FR-XC)	
(k)	Power regeneration common converter (FR-CV)	Provides a large braking capability. Install this as required.*2
(l)	Brake unit (FR-BU2)	
(m)	Resistor unit (FR-BR), discharge resistor (GZG, GRZG)	Allows the inverter to provide the optimal regenerative braking capability. Install this as required.
(n)	USB connection	Connect between the inverter and a personal computer with a USB (ver. 1.1) cable.
(o)	Brake resistor (FR-ABR, MRS, MYS)	Increases the braking capability. (0.4K or higher)
(p)	Noise filter (ferrite core) (FR-BSF01, FR-BLF)	Install this to reduce the electromagnetic noise generated from the inverter. The noise filter is effective in the range from about 0.5 to 5 MHz. A wire should be wound four turns at maximum.
(q)	Induction motor	Connect a squirrel-cage induction motor.
(r)	Example No-fuse switch (DSN type)	Connect this for an application where a PM motor is driven by the load even while the inverter power is OFF. Do not open or close the contactor while the inverter is running (outputting).
(s)	PM motor	An IPM motor cannot be driven by the commercial power supply.

*1 Not available for the FR-E800-SCE.

*2 Only the FR-XC in power regeneration mode is available for the FR-E800-SCE.

NOTE

- To prevent an electric shock, always earth (ground) the motor and inverter.
- Do not install a power factor correction capacitor, surge absorber, or radio noise filter on the output side of the inverter. Doing so will cause the inverter shut off or damage the capacitor or surge absorber. If any of the above devices is connected, immediately remove it. When installing a molded case circuit breaker on the output side of the inverter, contact the manufacturer of the molded case circuit breaker.
- Electromagnetic wave interference:
The input/output (main circuit) of the inverter includes high frequency components, which may interfere with the communication devices (such as AM radios) used near the inverter. Connect the optional radio noise filter FR-BIF (for use in the input side only), line noise filter FR-BSF01/FR-BLF, Filterpack, or EMC filter to minimize interference.
- For details of options and peripheral devices, refer to the respective Instruction Manual.
- A PM motor cannot be driven by the commercial power supply.
- A PM motor is a motor with permanent magnets embedded inside. High voltage is generated at the motor terminals while the motor is running. Before closing the contactor at the output side, make sure that the inverter power is ON and the motor is stopped.

Options

● Option List

By fitting the following options to the inverter, the inverter is provided with more functions.

	Name	Type	Applications	Applicable Inverter			Remarks
				E800	E800-E	E800-SCE	
Plug-in Type	Vector control (speed/torque/position control) Encoder feedback control	FR-A8AP E kit	Vector control can be performed for encoder-equipped motors (induction motors). The motor speed is sent back and the speed is maintained constant.	●	●	●	
	16-bit digital input	FR-A8AX E kit	This input interface sets the high frequency accuracy of the inverter using an external BCD or binary digital signal. · BCD code 3 digits (maximum 999) · BCD code 4 digits (maximum 9999) · Binary 12 bits (maximum FFFH) · Binary 16 bits (maximum FFFFH)	●	●	●	
	Digital output Extension analog output	FR-A8AY E kit	This option provides the inverter with open collector outputs selected from among the standard output signals. This option adds 2 different signals that can be monitored such as the output frequency and output voltage. 20mADC or 10VDC meter can be connected.	●	●	●	
	Relay output	FR-A8AR E kit	Output any three output signals available with the inverter as standard from the relay contact terminals.	●	●	●	
	24 VDC input	FR-E8DS E kit	This option allows maintaining the I/O terminal function and the operation panel function (indication and key operation) even at power-OFF of inverter's main circuit power supply.	●	●	●	
	CC-Link communication	FR-A8NC E kit	This option allows the inverter to be operated or monitored or the parameter setting to be changed from a computer or programmable controller.	●	●	●	
	DeviceNet communication	FR-A8ND E kit		●	●	●	
PROFIBUS-DP communication	FR-A8NP E kit	●		●	●		
Stand-alone type	LCD operation panel	FR-LU08 (-01)	Graphical operation panel with liquid crystal display	●	-	-	
	Parameter unit	FR-PU07	Interactive parameter unit with LCD display	●	-	-	
	Parameter unit with battery pack	FR-PU07BB (-L)	This parameter unit enables parameter setting without connecting the inverter to power supply.	●	-	-	
	Enclosure surface operation panel	FR-PA07	This operation panel enables inverter operation and monitoring of frequency, etc. from the enclosure surface	●	-	-	
	Parameter unit connection cable	FR-CB20[]	Cable for connection of operation panel or parameter unit [] indicates a cable length. (1m, 3m, 5m)	●	-	-	
	Encoder cable Mitsubishi Electric vector control dedicated motor (SFV5RU)	FR-V7CBL[]	Connection cable for the inverter and encoder for Mitsubishi Electric vector control dedicated motor (SFV5RU). [] indicates a cable length. (5m, 15m, 30m)	●	●	●	
	USB cable	MR-J3USBCBL3M Cable length: 3 m	Amplifier connector Mini B connector (5-pin)  Personal computer connector A connector	●	●	●	
	Intercompatibility attachment	FR-E7AT 01/02/03	For installation of a FR-E800 series inverter to the installation holes of FR-A024/A044 series inverter.	●	●	●	3.7K or lower.
		FR-E8AT03	For installation of a FR-E700/E800 inverter to the installation holes of FR-A024/A044 series inverter.	●	●	●	FR-E820-3.7K
		FR-E8AT04	For installation of a FR-E700/E800 inverter to the installation holes of FR-A024/A044/E700 inverter.	●	●	●	FR-E820S-2.2K
	DIN rail attachment	FR-UDA 01 to 03	Attachment for installation on DIN rail	●	●	●	3.7K or lower.
	Panel through attachment	FR-E8CN 01 to 06	Using this attachment dissipates the inverter's heat by having the inverter heat sink protrude from the back side of the enclosure.	●	●	●	
	Totally enclosed structure specification attachment (IP40)	FR-E8CV 01 to 04	Installing the attachment to the inverter changes the protective structure of the inverter to the totally enclosed structure (IP40 equivalent as specified by JEM 1030).	○	○	○	
	AC reactor	FR-HAL	For harmonic current reduction and inverter input power factor improvement	●	●	●	
	DC reactor	FR-HEL	For harmonic current reduction and inverter input power factor improvement	●	●	●	
	EMC Directive compliant noise filter	SF, FR-E5NF, FR-S5NFSA	EMC Directive (EN 61800-3 C3) compliant noise filter	●	●	●	
	EMC compliant EMC filter installation attachment	FR-A5AT03, FR-AAT02, FR-E5T(-02)	For installation of the inverter to the EMC Directive compliant EMC filter (SF).	●	●	●	
Radio noise filter	FR-BIF(H)	For radio noise reduction (connect to the input side)	●	●	●		
Line noise filter	FR-BSF01, FR-BLF	For line noise reduction	●	●	●		
Filterpack	FR-BFP2	Combination of power factor improving DC reactor, common mode choke, and capacitive filter	●	●	●	0.4K to 15K of the three-phase power input model.	

●: Supported ○: To be supported soon -: Not supported

	Name	Type	Applications	Applicable Inverter			
				E800	E800-E	E800-SCE	Remarks
Stand-alone type	Brake resistor	MRS type, MYS type	For increasing the regenerative braking capability (permissible duty 3%ED)	•	•	•	0.4K or higher.
	High-duty brake resistor	FR-ABR	For increasing the regenerative braking capability (permissible duty 10%/6%ED)	•	•	•	
	Brake unit, Resistor unit, Discharging resistor	FR-BU2, FR-BR, GZG, GRZG type	For increasing the braking capability of the inverter (for high-inertia load or negative load) Brake unit, electrical-discharge resistor and resistor unit are used in combination	•	•	•	
	Multifunction regeneration converter Dedicated stand-alone reactor Dedicated box-type reactor	FR-XC, FR-XCL/FR-XCG, FR-XCB	One inverter can handle harmonic suppression and power regeneration. Functions that match the application can be selected by combining the inverter/converter with the dedicated reactor FR-XCB (box-type) or FR-XCL/FR-XCG.	•	•	•	
	High power factor converter	FR-HC2	The high power factor converter switches the converter section on/off to reshape an input current waveform into a sine wave, greatly suppressing harmonics. (Used in combination with the standard accessory.)	•	•	-	
	Surge voltage suppression filter	FR-ASF	Filter for suppressing surge voltage on motor	•	•	•	400V
		FR-BMF					400V: 5.5K or higher
Others	Pilot generator	QVAH-10	For tracking operation. 70 V / 35 VAC 500 Hz (at 2500 r/min)	•	•	•	
	Deviation sensor	YVGC-500WNS	For continuous speed control operation (mechanical deviation detection) Output 90VAC /90°	•	•	•	
	Analog frequency meter (64mm × 60mm)	YM-206NRI 1mA	Dedicated frequency meter (graduated to 130 Hz). Moving-coil type DC ammeter	•	-	-	
	Calibration resistor	RV24YN 10kΩ	For frequency meter calibration. Carbon film type B characteristic	•	•	•	
	FR Configurator2 (Inverter setup software)	SW1DND-FRC2	Supports an inverter startup to maintenance.	•	•	•	
	FR Configurator Mobile (Mobile App for Inverters)	-	The app enables operation of inverters using smart phones or tablets.	-	•	•	

•: Supported ◦: To be supported soon -: Not supported

● Stand-alone option

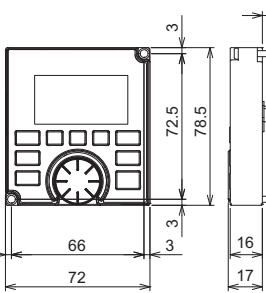
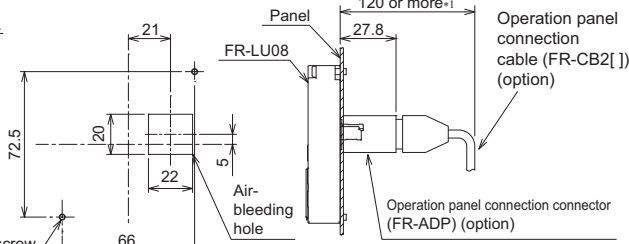
Name (model)	Specification and structure
<p data-bbox="134 416 320 456">LCD operation panel FR-LU08(-01)</p>  <p data-bbox="129 707 328 763">Operation panel connection connector FR-ADP</p>	<p data-bbox="347 264 890 286">The LCD operation panel is capable of displaying text and menus.</p> <ul data-bbox="347 286 1437 533" style="list-style-type: none"> • Features <ul style="list-style-type: none"> Replacement with the operation panel (FR-DU08) and installation on the enclosure surface using a connection cable (FR-CB2) are possible. (To connect the FR-LU08, an optional operation panel connection connector (FR-ADP) is required.) Parameter settings of one inverter can be stored. When the FR-LU08 is connected to the inverter, the internal clock of the inverter can be synchronized with the clock of FR-LU08. (Real time clock function) With a battery (CR1216), the FR-LU08 time count continues even if the main power of the inverter is turned OFF. (The time count of the inverter internal clock does not continue when the inverter power is turned OFF.) The FR-LU08-01 meets the IP55 rating (except for the PU connector). • Outline dimension (Unit: mm) <div data-bbox="389 544 1362 913"> <p data-bbox="389 544 555 566"><Outline drawing></p>  <p data-bbox="730 544 1050 566"><Panel cutting dimension drawing></p>  <p data-bbox="762 824 1241 913">*1 Denotes the combined length of the two connectors when the operation panel connection cable (FR-CB2[]) is connected to the operation panel connection connector (FR-ADP). The combined length of the two connectors will be different if other (3rd party) operation panel connection cables are used.</p> </div>

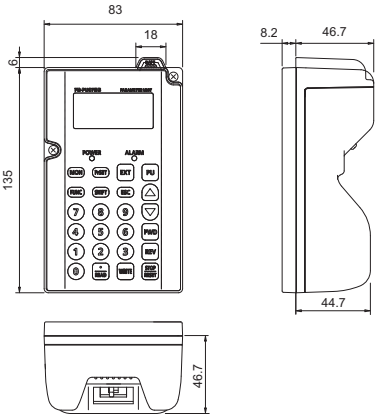
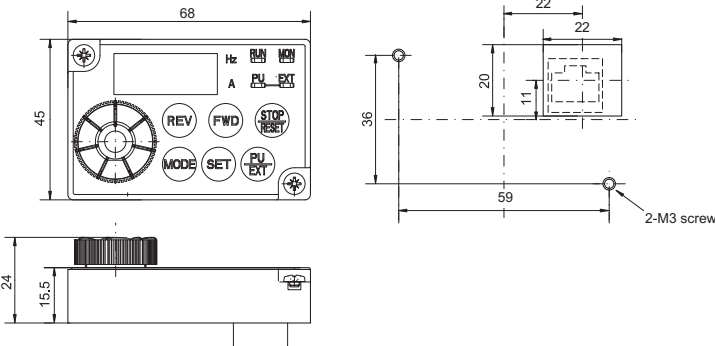
Name (model)	Specification and structure																																				
<p>Parameter unit with battery pack FR-PU07BB(-L)</p> 	<p>This parameter unit enables parameter setting without connecting the inverter to power supply. Uses 4 × AA batteries. Can also be powered by an external 100 VAC power supply.</p> <p>• Specifications</p> <table border="1" data-bbox="400 300 1465 770"> <thead> <tr> <th>Item</th> <th colspan="3">Description</th> </tr> </thead> <tbody> <tr> <td>Power supply</td> <td colspan="3"> <ul style="list-style-type: none"> When driven by batteries AA batteries four (nickel hydride(NiMH)/alkali) When driven by external power supply (100 VAC) AC adaptor *1 When power is applied to the inverter Power is supplied from the PU connector of the inverter. </td> </tr> <tr> <td rowspan="2">Battery life *2</td> <td>Battery life</td> <td>Alkaline battery</td> <td>Nickel metal hydride battery</td> </tr> <tr> <td>Battery exhaustion warning lamp color changing start time From green to orange (at lowering of battery power)</td> <td>Approx. 260 min</td> <td>Approx. 340 min</td> </tr> <tr> <td>Switch · connector</td> <td colspan="3">Battery ON/OFF switch Modular connector for inverter connection and connector for AC adaptor connection</td> </tr> <tr> <td>Display functions</td> <td colspan="3">Alarm LED for battery exhaustion, Other display is the same as the FR-PU07.</td> </tr> <tr> <td>Provided appliances</td> <td colspan="3">AA alkali battery (for operation check) four *3 Connection cable (FR-CB203) one</td> </tr> </tbody> </table> <p>*1 Use an AC adaptor with the following specifications.</p> <table border="1" data-bbox="434 804 1056 920"> <thead> <tr> <th rowspan="4">Output specifications</th> <th>Rated voltage</th> <td>5.0 VDC±5% or less</td> </tr> </thead> <tbody> <tr> <th>Rated current</th> <td>2 A or more</td> </tr> <tr> <th>Polarity</th> <td>Plus polarity in the center.</td> </tr> <tr> <th>Plug</th> <td>JEITA RC-5320A compliant</td> </tr> </tbody> </table> <p>*2 The battery life is a reference value. It differs depending on the battery and the usage. *3 Batteries are not included in FR-PU07BB-L.</p> <p>• Outline dimension (Unit: mm)</p> <p><Outline drawing></p> 	Item	Description			Power supply	<ul style="list-style-type: none"> When driven by batteries AA batteries four (nickel hydride(NiMH)/alkali) When driven by external power supply (100 VAC) AC adaptor *1 When power is applied to the inverter Power is supplied from the PU connector of the inverter. 			Battery life *2	Battery life	Alkaline battery	Nickel metal hydride battery	Battery exhaustion warning lamp color changing start time From green to orange (at lowering of battery power)	Approx. 260 min	Approx. 340 min	Switch · connector	Battery ON/OFF switch Modular connector for inverter connection and connector for AC adaptor connection			Display functions	Alarm LED for battery exhaustion, Other display is the same as the FR-PU07.			Provided appliances	AA alkali battery (for operation check) four *3 Connection cable (FR-CB203) one			Output specifications	Rated voltage	5.0 VDC±5% or less	Rated current	2 A or more	Polarity	Plus polarity in the center.	Plug	JEITA RC-5320A compliant
Item	Description																																				
Power supply	<ul style="list-style-type: none"> When driven by batteries AA batteries four (nickel hydride(NiMH)/alkali) When driven by external power supply (100 VAC) AC adaptor *1 When power is applied to the inverter Power is supplied from the PU connector of the inverter. 																																				
Battery life *2	Battery life	Alkaline battery	Nickel metal hydride battery																																		
	Battery exhaustion warning lamp color changing start time From green to orange (at lowering of battery power)	Approx. 260 min	Approx. 340 min																																		
Switch · connector	Battery ON/OFF switch Modular connector for inverter connection and connector for AC adaptor connection																																				
Display functions	Alarm LED for battery exhaustion, Other display is the same as the FR-PU07.																																				
Provided appliances	AA alkali battery (for operation check) four *3 Connection cable (FR-CB203) one																																				
Output specifications	Rated voltage	5.0 VDC±5% or less																																			
	Rated current	2 A or more																																			
	Polarity	Plus polarity in the center.																																			
	Plug	JEITA RC-5320A compliant																																			
<p>Enclosure surface operation panel FR-PA07</p>	<p>This operation panel can be mounted to an enclosure surface to enable inverter operation and monitoring of frequency, etc. (This product does not have the parameter copy function.)</p> <p>• Outline dimension (Unit: mm)</p> 																																				
<p>Parameter unit connection cable FR-CB20[]</p>	<p>This cable is for connection of operation panel or parameter unit</p> <p>• Specifications</p> <table border="1" data-bbox="437 1957 740 2065"> <thead> <tr> <th>Model</th> <th>Length</th> </tr> </thead> <tbody> <tr> <td>FR-CB201</td> <td>1m</td> </tr> <tr> <td>FR-CB203</td> <td>3m</td> </tr> <tr> <td>FR-CB205</td> <td>5m</td> </tr> </tbody> </table>	Model	Length	FR-CB201	1m	FR-CB203	3m	FR-CB205	5m																												
Model	Length																																				
FR-CB201	1m																																				
FR-CB203	3m																																				
FR-CB205	5m																																				

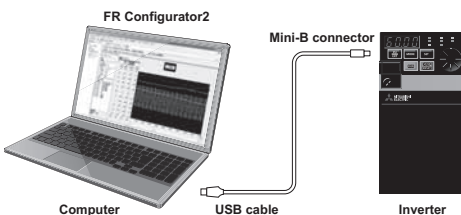
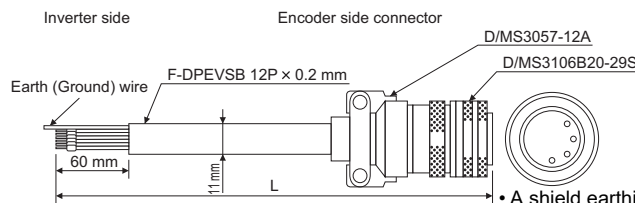
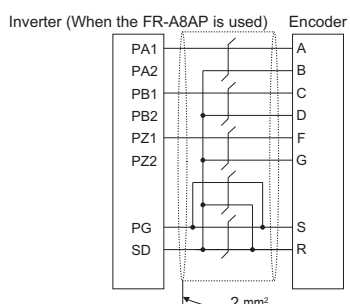
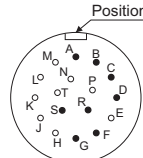
Name (model)	Specification and structure																																			
<p>USB cable MR-J3USBCBL3M</p>	<p>USB cable for communication with the inverter using the USB port of the PC.</p>  <p>Computer USB cable Inverter</p>																																			
<p>Encoder cable FR-V7CBL[]</p>	<p>• For dedicated motors</p>  <p>Inverter side Encoder side connector</p> <p>Earth (Ground) wire F-DPEVSB 12P x 0.2 mm D/MS3057-12A D/MS3106B20-29S</p> <p>60 mm 11 mm L</p> <p>• A shield earthing (grounding) P-clip is included.</p>  <p>Inverter (When the FR-A8AP is used) Encoder</p>  <p>Positioning guide (key groove)</p> <p>D/MS3106B20-29S (As viewed from wiring side)</p> <table border="1" data-bbox="750 952 1053 1064"> <thead> <tr> <th>Model</th> <th>Length L (m)</th> </tr> </thead> <tbody> <tr> <td>FR-V7CBL5</td> <td>5</td> </tr> <tr> <td>FR-V7CBL15</td> <td>15</td> </tr> <tr> <td>FR-V7CBL30</td> <td>30</td> </tr> </tbody> </table> <p>• For cables of 30 m or longer, contact your sales representative.</p> <p>• Cable fabrication specifications</p> <ul style="list-style-type: none"> When option connection cables are not available, fabricate cables according to the following table. Use parallel connection or a large-gauge cable for wiring between terminals PG and SD and the motor end encoder. (For cables for other terminals, use cables 0.2 mm².) <table border="1" data-bbox="367 1232 1372 1500"> <thead> <tr> <th rowspan="2">Wiring distance</th> <th rowspan="2">Options dedicated encoder cable</th> <th colspan="2">Cable gauge for terminals PG and SD</th> </tr> <tr> <th>For wiring using cables 0.2 mm²</th> <th>For wiring using a cable with larger gauge</th> </tr> </thead> <tbody> <tr> <td>5 m or lower</td> <td>FR-V7CBL5</td> <td>2 or more cables in parallel</td> <td rowspan="2">0.4 mm² or more</td> </tr> <tr> <td>10 m or lower</td> <td rowspan="2">FR-V7CBL15</td> <td>2 or more cables in parallel</td> </tr> <tr> <td>15 m or lower</td> <td>4 or more cables in parallel</td> <td rowspan="2">0.75 mm² or more</td> </tr> <tr> <td>20 m or lower</td> <td rowspan="2">FR-V7CBL30</td> <td>4 or more cables in parallel</td> </tr> <tr> <td>30 m or lower</td> <td>6 or more cables in parallel</td> </tr> <tr> <td>50 m or lower</td> <td>Cables on order</td> <td rowspan="2">6 or more cables in parallel</td> <td rowspan="2">1.25 mm² or more</td> </tr> <tr> <td>100 m or lower</td> <td>Consult us separately.</td> </tr> </tbody> </table>	Model	Length L (m)	FR-V7CBL5	5	FR-V7CBL15	15	FR-V7CBL30	30	Wiring distance	Options dedicated encoder cable	Cable gauge for terminals PG and SD		For wiring using cables 0.2 mm ²	For wiring using a cable with larger gauge	5 m or lower	FR-V7CBL5	2 or more cables in parallel	0.4 mm ² or more	10 m or lower	FR-V7CBL15	2 or more cables in parallel	15 m or lower	4 or more cables in parallel	0.75 mm ² or more	20 m or lower	FR-V7CBL30	4 or more cables in parallel	30 m or lower	6 or more cables in parallel	50 m or lower	Cables on order	6 or more cables in parallel	1.25 mm ² or more	100 m or lower	Consult us separately.
Model	Length L (m)																																			
FR-V7CBL5	5																																			
FR-V7CBL15	15																																			
FR-V7CBL30	30																																			
Wiring distance	Options dedicated encoder cable	Cable gauge for terminals PG and SD																																		
		For wiring using cables 0.2 mm ²	For wiring using a cable with larger gauge																																	
5 m or lower	FR-V7CBL5	2 or more cables in parallel	0.4 mm ² or more																																	
10 m or lower	FR-V7CBL15	2 or more cables in parallel																																		
15 m or lower		4 or more cables in parallel	0.75 mm ² or more																																	
20 m or lower	FR-V7CBL30	4 or more cables in parallel																																		
30 m or lower		6 or more cables in parallel																																		
50 m or lower	Cables on order	6 or more cables in parallel	1.25 mm ² or more																																	
100 m or lower	Consult us separately.																																			

Name (model)	Specification and structure																								
<p style="text-align: center;">Intercompatibility attachment FR-E7AT01/02/03</p>	<p>Intercompatibility attachment This attachment is used to install the FR-E800 series inverter using the installation holes of the FR-A024/FR-A044/FR-E700 series inverter. (The depth increases after installation of the inverter when the attachment is used.)</p> <ul style="list-style-type: none"> • Replacing the FR-A024/FR-A044 inverter with the FR-E820/FR-E840 inverter 																								
	<table border="1"> <thead> <tr> <th colspan="2">Compatible Former Model</th> <th colspan="2">Mountable Model</th> <th>Intercompatibility Attachment</th> </tr> </thead> <tbody> <tr> <td rowspan="3">FR-A024</td> <td>0.1K to 0.75K</td> <td rowspan="3">FR-E820</td> <td>0008 (0.1K) to 0050 (0.75K)</td> <td>FR-E7AT01</td> </tr> <tr> <td>1.5K</td> <td>0080 (1.5K)</td> <td>FR-E7AT02</td> </tr> <tr> <td>2.2K, 3.7K</td> <td>0110 (2.2K), 0175 (3.7K)</td> <td>FR-E7AT03</td> </tr> <tr> <td rowspan="2">FR-A044</td> <td>0.4K, 0.75K</td> <td rowspan="2">FR-E840</td> <td>0016 (0.4K), 0026 (0.75K)</td> <td>FR-E7AT02</td> </tr> <tr> <td>1.5K to 3.7K</td> <td>0040 (1.5K) to 0095 (3.7K)</td> <td>FR-E7AT03</td> </tr> </tbody> </table>	Compatible Former Model		Mountable Model		Intercompatibility Attachment	FR-A024	0.1K to 0.75K	FR-E820	0008 (0.1K) to 0050 (0.75K)	FR-E7AT01	1.5K	0080 (1.5K)	FR-E7AT02	2.2K, 3.7K	0110 (2.2K), 0175 (3.7K)	FR-E7AT03	FR-A044	0.4K, 0.75K	FR-E840	0016 (0.4K), 0026 (0.75K)	FR-E7AT02	1.5K to 3.7K	0040 (1.5K) to 0095 (3.7K)	FR-E7AT03
	Compatible Former Model		Mountable Model		Intercompatibility Attachment																				
	FR-A024	0.1K to 0.75K	FR-E820	0008 (0.1K) to 0050 (0.75K)	FR-E7AT01																				
		1.5K		0080 (1.5K)	FR-E7AT02																				
		2.2K, 3.7K		0110 (2.2K), 0175 (3.7K)	FR-E7AT03																				
	FR-A044	0.4K, 0.75K	FR-E840	0016 (0.4K), 0026 (0.75K)	FR-E7AT02																				
		1.5K to 3.7K		0040 (1.5K) to 0095 (3.7K)	FR-E7AT03																				
	<ul style="list-style-type: none"> • Replacing the FR-E740 inverter with the FR-E840 inverter 																								
	<table border="1"> <thead> <tr> <th colspan="2">Compatible Former Model</th> <th colspan="2">Mountable Model</th> <th>Intercompatibility Attachment</th> </tr> </thead> <tbody> <tr> <td rowspan="2">FR-E740</td> <td>0.4K to 1.5K</td> <td rowspan="2">FR-E840</td> <td>0016 (0.4K) to 0040 (1.5K)</td> <td>FR-E7AT02</td> </tr> <tr> <td>2.2K, 3.7K</td> <td>0060 (2.2K), 0095 (3.7K)</td> <td>—</td> </tr> </tbody> </table>	Compatible Former Model		Mountable Model		Intercompatibility Attachment	FR-E740	0.4K to 1.5K	FR-E840	0016 (0.4K) to 0040 (1.5K)	FR-E7AT02	2.2K, 3.7K	0060 (2.2K), 0095 (3.7K)	—											
Compatible Former Model		Mountable Model		Intercompatibility Attachment																					
FR-E740	0.4K to 1.5K	FR-E840	0016 (0.4K) to 0040 (1.5K)	FR-E7AT02																					
	2.2K, 3.7K		0060 (2.2K), 0095 (3.7K)	—																					
<p>—: The attachment is not required. To replace the FR-E720 inverter with the FR-E820 inverter, use the FR-E8AT03</p>																									
<ul style="list-style-type: none"> • Outline dimension (Unit: mm) 																									
<ul style="list-style-type: none"> • FR-E7AT01 																									
<ul style="list-style-type: none"> • FR-E7AT02 																									
<ul style="list-style-type: none"> • FR-E7AT03 																									

Name (model)	Specification and structure																																							
<p>Intercompatibility attachment FR-E8AT03, 04</p>	<p>Intercompatibility attachment This attachment is used to install the FR-E800 series inverter using the installation holes of the FR-E700 series inverter. (The depth increases after installation of the inverter when the attachment is used.)</p> <ul style="list-style-type: none"> Replacing the FR-E720 inverter with the FR-E820 inverter <table border="1" data-bbox="357 320 1369 454"> <thead> <tr> <th colspan="2">Compatible former model</th> <th colspan="2">Mountable model</th> <th>Intercompatibility attachment</th> </tr> </thead> <tbody> <tr> <td rowspan="2">FR-E720</td> <td>0.1K to 2.2K</td> <td rowspan="2">FR-E820</td> <td>0.1K (0008) to 2.2K (0110)</td> <td>—</td> </tr> <tr> <td>3.7K</td> <td>3.7K (0175)</td> <td>FR-E8AT03</td> </tr> <tr> <td rowspan="2">FR-E720S</td> <td>0.1K to 1.5K</td> <td rowspan="2">FR-E820S</td> <td>0.1K (0008) to 1.5K (0080)</td> <td>—</td> </tr> <tr> <td>2.2K</td> <td>2.2K (0110)</td> <td>FR-E8AT04</td> </tr> </tbody> </table> <p>—: The attachment is not required. To replace the FR-E740 inverter with the FR-E840 inverter, use the FR-E7AT02.</p> <ul style="list-style-type: none"> Outline dimension (Unit: mm) <div style="display: flex; justify-content: space-around;"> <div data-bbox="357 533 813 952"> <p>FR-E8AT03</p> </div> <div data-bbox="877 533 1420 929"> <p>FR-E8AT04</p> </div> </div>	Compatible former model		Mountable model		Intercompatibility attachment	FR-E720	0.1K to 2.2K	FR-E820	0.1K (0008) to 2.2K (0110)	—	3.7K	3.7K (0175)	FR-E8AT03	FR-E720S	0.1K to 1.5K	FR-E820S	0.1K (0008) to 1.5K (0080)	—	2.2K	2.2K (0110)	FR-E8AT04																		
Compatible former model		Mountable model		Intercompatibility attachment																																				
FR-E720	0.1K to 2.2K	FR-E820	0.1K (0008) to 2.2K (0110)	—																																				
	3.7K		3.7K (0175)	FR-E8AT03																																				
FR-E720S	0.1K to 1.5K	FR-E820S	0.1K (0008) to 1.5K (0080)	—																																				
	2.2K		2.2K (0110)	FR-E8AT04																																				
<p>DIN rail installation attachment FR-UDA01 to 03</p>	<p>Use of attachment enables the inverter to be installed on DIN rail.</p> <ul style="list-style-type: none"> Selection table <table border="1" data-bbox="357 1014 1425 1144"> <thead> <tr> <th rowspan="2">Attachment Model</th> <th colspan="4">Inverter Capacity</th> </tr> <tr> <th>E820</th> <th>E840</th> <th>E820S</th> <th>E810W</th> </tr> </thead> <tbody> <tr> <td>FR-UDA01</td> <td>0.1K, 0.2K, 0.4K, 0.75K</td> <td>—</td> <td>0.1K, 0.2K, 0.4K</td> <td>0.1K, 0.2K, 0.4K</td> </tr> <tr> <td>FR-UDA02</td> <td>1.5K, 2.2K</td> <td>0.4K, 0.75K, 1.5K</td> <td>0.75K, 1.5K</td> <td>0.75K</td> </tr> <tr> <td>FR-UDA03</td> <td>3.7K</td> <td>—</td> <td>2.2K</td> <td>—</td> </tr> </tbody> </table> <ul style="list-style-type: none"> Outline dimension (Unit: mm) <div style="display: flex; justify-content: space-around;"> <div data-bbox="357 1189 622 1547"> <p>FR-UDA01</p> </div> <div data-bbox="670 1189 981 1547"> <p>FR-UDA02</p> </div> <div data-bbox="1021 1189 1380 1525"> <p>FR-UDA03</p> </div> </div>	Attachment Model	Inverter Capacity				E820	E840	E820S	E810W	FR-UDA01	0.1K, 0.2K, 0.4K, 0.75K	—	0.1K, 0.2K, 0.4K	0.1K, 0.2K, 0.4K	FR-UDA02	1.5K, 2.2K	0.4K, 0.75K, 1.5K	0.75K, 1.5K	0.75K	FR-UDA03	3.7K	—	2.2K	—															
Attachment Model	Inverter Capacity																																							
	E820	E840	E820S	E810W																																				
FR-UDA01	0.1K, 0.2K, 0.4K, 0.75K	—	0.1K, 0.2K, 0.4K	0.1K, 0.2K, 0.4K																																				
FR-UDA02	1.5K, 2.2K	0.4K, 0.75K, 1.5K	0.75K, 1.5K	0.75K																																				
FR-UDA03	3.7K	—	2.2K	—																																				
<p>Panel Through Attachment FR-E8CN01 to 06</p>	<p>Using this attachment dissipates about 70% of the inverter's heat by having the inverter heat sink protrude from the back side of the enclosure.</p> <ul style="list-style-type: none"> Selection table <table border="1" data-bbox="357 1630 979 1843"> <thead> <tr> <th rowspan="2">Attachment Model</th> <th colspan="4">Inverter Capacity</th> </tr> <tr> <th>E820</th> <th>E840</th> <th>E860</th> <th>E820S</th> </tr> </thead> <tbody> <tr> <td>FR-E8CN01</td> <td>1.5K, 2.2K</td> <td>—</td> <td>—</td> <td>1.5K</td> </tr> <tr> <td>FR-E8CN02</td> <td>3.7K</td> <td>—</td> <td>—</td> <td>2.2K</td> </tr> <tr> <td>FR-E8CN03</td> <td>5.5K, 7.5K</td> <td>—</td> <td>—</td> <td>—</td> </tr> <tr> <td>FR-E8CN04</td> <td>—</td> <td>1.5K</td> <td>—</td> <td>—</td> </tr> <tr> <td>FR-E8CN05</td> <td>—</td> <td>2.2K, 3.7K</td> <td>1.5K, 2.2K</td> <td>—</td> </tr> <tr> <td>FR-E8CN06</td> <td>—</td> <td>5.5K, 7.5K</td> <td>3.7K to 7.5K</td> <td>—</td> </tr> </tbody> </table> <div style="text-align: right; margin-top: 20px;"> </div>	Attachment Model	Inverter Capacity				E820	E840	E860	E820S	FR-E8CN01	1.5K, 2.2K	—	—	1.5K	FR-E8CN02	3.7K	—	—	2.2K	FR-E8CN03	5.5K, 7.5K	—	—	—	FR-E8CN04	—	1.5K	—	—	FR-E8CN05	—	2.2K, 3.7K	1.5K, 2.2K	—	FR-E8CN06	—	5.5K, 7.5K	3.7K to 7.5K	—
Attachment Model	Inverter Capacity																																							
	E820	E840	E860	E820S																																				
FR-E8CN01	1.5K, 2.2K	—	—	1.5K																																				
FR-E8CN02	3.7K	—	—	2.2K																																				
FR-E8CN03	5.5K, 7.5K	—	—	—																																				
FR-E8CN04	—	1.5K	—	—																																				
FR-E8CN05	—	2.2K, 3.7K	1.5K, 2.2K	—																																				
FR-E8CN06	—	5.5K, 7.5K	3.7K to 7.5K	—																																				

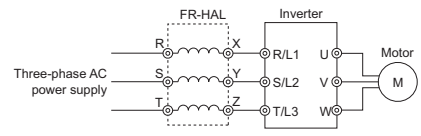
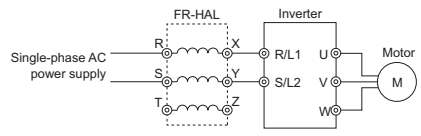
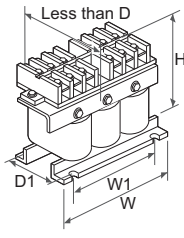
Name (model)	Specification and structure																																																																																																																																																																																																																		
<p style="text-align: center;">AC reactor (for power supply coordination) FR-HAL</p> 	<p>Improves the power factor and reduces the harmonic current at the input side. Connect an AC reactor at the input side of the inverter.</p> <ul style="list-style-type: none"> • Selection method Select an AC reactor according to the applied motor capacity. (Select the AC reactor according to the motor capacity even if the capacity is smaller than the inverter capacity.) • Connection diagram <div style="display: flex; justify-content: space-around;"> <div data-bbox="391 347 813 504"> <p><Three-phase power supply></p>  </div> <div data-bbox="829 347 1252 504"> <p><Single-phase power supply></p>  </div> </div> <ul style="list-style-type: none"> • Outline dimension (Unit: mm) <table border="1" data-bbox="391 548 909 918"> <thead> <tr> <th>Model</th> <th>W</th> <th>W1</th> <th>H</th> <th>D</th> <th>D1</th> <th>d</th> <th>Mass (kg)</th> </tr> </thead> <tbody> <tr><td rowspan="10" style="writing-mode: vertical-rl; transform: rotate(180deg);">200V</td> <td>0.4K</td><td>104</td><td>84</td><td>99</td><td>72</td><td>40</td><td>M5</td><td>0.6</td></tr> <tr><td>0.75K</td><td>104</td><td>84</td><td>99</td><td>74</td><td>44</td><td>M5</td><td>0.8</td></tr> <tr><td>1.5K</td><td>104</td><td>84</td><td>99</td><td>77</td><td>50</td><td>M5</td><td>1.1</td></tr> <tr><td>2.2K</td><td>115</td><td>40</td><td>115</td><td>77</td><td>57</td><td>M6</td><td>1.5</td></tr> <tr><td>3.7K</td><td>115</td><td>40</td><td>115</td><td>83</td><td>67</td><td>M6</td><td>2.2</td></tr> <tr><td>5.5K</td><td>115</td><td>40</td><td>115</td><td>83</td><td>67</td><td>M6</td><td>2.3</td></tr> <tr><td>7.5K</td><td>130</td><td>50</td><td>135</td><td>100</td><td>86</td><td>M6</td><td>4.2</td></tr> <tr><td>11K</td><td>160</td><td>75</td><td>164</td><td>111</td><td>92</td><td>M6</td><td>5.2</td></tr> <tr><td>15K</td><td>160</td><td>75</td><td>167</td><td>126</td><td>107</td><td>M6</td><td>7.0</td></tr> <tr><td>18.5K</td><td>160</td><td>75</td><td>128</td><td>175</td><td>107</td><td>M6</td><td>7.1</td></tr> <tr><td>22K</td><td>185</td><td>75</td><td>150</td><td>158</td><td>87</td><td>M6</td><td>9.0</td></tr> <tr><td>30K</td><td>185</td><td>75</td><td>150</td><td>168</td><td>87</td><td>M6</td><td>9.7</td></tr> </tbody> </table> <table border="1" data-bbox="933 537 1452 907"> <thead> <tr> <th>Model</th> <th>W</th> <th>W1</th> <th>H</th> <th>D</th> <th>D1</th> <th>d</th> <th>Mass (kg)</th> </tr> </thead> <tbody> <tr><td rowspan="13" style="writing-mode: vertical-rl; transform: rotate(180deg);">400V</td> <td>H0.4K</td><td>135</td><td>120</td><td>115</td><td>64</td><td>45</td><td>M4</td><td>1.5</td></tr> <tr><td>H0.75K</td><td>135</td><td>120</td><td>115</td><td>64</td><td>45</td><td>M4</td><td>1.5</td></tr> <tr><td>H1.5K</td><td>135</td><td>120</td><td>115</td><td>64</td><td>45</td><td>M4</td><td>1.5</td></tr> <tr><td>H2.2K</td><td>135</td><td>120</td><td>115</td><td>64</td><td>45</td><td>M4</td><td>1.5</td></tr> <tr><td>H3.7K</td><td>135</td><td>120</td><td>115</td><td>74</td><td>57</td><td>M4</td><td>2.5</td></tr> <tr><td>H5.5K</td><td>160</td><td>145</td><td>150</td><td>76</td><td>55</td><td>M4</td><td>3.5</td></tr> <tr><td>H7.5K</td><td>160</td><td>145</td><td>150</td><td>96</td><td>75</td><td>M4</td><td>5.0</td></tr> <tr><td>H11K</td><td>160</td><td>145</td><td>146</td><td>96</td><td>75</td><td>M4</td><td>6.0</td></tr> <tr><td>H15K</td><td>220</td><td>200</td><td>195</td><td>105</td><td>70</td><td>M5</td><td>9.0</td></tr> <tr><td>H18.5K</td><td>220</td><td>200</td><td>212</td><td>155</td><td>70</td><td>M5</td><td>9.0</td></tr> <tr><td>H22K</td><td>220</td><td>200</td><td>212</td><td>155</td><td>70</td><td>M5</td><td>9.5</td></tr> <tr><td>H30K</td><td>220</td><td>200</td><td>212</td><td>153</td><td>75</td><td>M5</td><td>11</td></tr> </tbody> </table> <ul style="list-style-type: none"> (a) Approximately 88% of the power factor improving effect can be obtained (92.3% when calculated with 1 power factor for the fundamental wave according to the Architectural Standard Specifications (Electrical Installation) supervised by the Ministry of Land, Infrastructure, Transport and Tourism of Japan). (b) This is a sample outline dimension drawing. The shape differs by the model. W1 and D1 indicate distances between installation holes. The installation hole size is indicated by d. (c) When installing an AC reactor (FR-HAL), install in the orientation shown below. (H)55K or lower: Horizontal installation or vertical installation (H)75K or higher: Horizontal installation (d) Keep enough clearance around the reactor because it heats up. (Keep a clearance of minimum 10cm each on top and bottom and minimum 5cm each on right and left regardless of the installation orientation.) 	Model	W	W1	H	D	D1	d	Mass (kg)	200V	0.4K	104	84	99	72	40	M5	0.6	0.75K	104	84	99	74	44	M5	0.8	1.5K	104	84	99	77	50	M5	1.1	2.2K	115	40	115	77	57	M6	1.5	3.7K	115	40	115	83	67	M6	2.2	5.5K	115	40	115	83	67	M6	2.3	7.5K	130	50	135	100	86	M6	4.2	11K	160	75	164	111	92	M6	5.2	15K	160	75	167	126	107	M6	7.0	18.5K	160	75	128	175	107	M6	7.1	22K	185	75	150	158	87	M6	9.0	30K	185	75	150	168	87	M6	9.7	Model	W	W1	H	D	D1	d	Mass (kg)	400V	H0.4K	135	120	115	64	45	M4	1.5	H0.75K	135	120	115	64	45	M4	1.5	H1.5K	135	120	115	64	45	M4	1.5	H2.2K	135	120	115	64	45	M4	1.5	H3.7K	135	120	115	74	57	M4	2.5	H5.5K	160	145	150	76	55	M4	3.5	H7.5K	160	145	150	96	75	M4	5.0	H11K	160	145	146	96	75	M4	6.0	H15K	220	200	195	105	70	M5	9.0	H18.5K	220	200	212	155	70	M5	9.0	H22K	220	200	212	155	70	M5	9.5	H30K	220	200	212	153	75	M5	11
	Model	W	W1	H	D	D1	d	Mass (kg)																																																																																																																																																																																																											
200V	0.4K	104	84	99	72	40	M5	0.6																																																																																																																																																																																																											
	0.75K	104	84	99	74	44	M5	0.8																																																																																																																																																																																																											
	1.5K	104	84	99	77	50	M5	1.1																																																																																																																																																																																																											
	2.2K	115	40	115	77	57	M6	1.5																																																																																																																																																																																																											
	3.7K	115	40	115	83	67	M6	2.2																																																																																																																																																																																																											
	5.5K	115	40	115	83	67	M6	2.3																																																																																																																																																																																																											
	7.5K	130	50	135	100	86	M6	4.2																																																																																																																																																																																																											
	11K	160	75	164	111	92	M6	5.2																																																																																																																																																																																																											
	15K	160	75	167	126	107	M6	7.0																																																																																																																																																																																																											
	18.5K	160	75	128	175	107	M6	7.1																																																																																																																																																																																																											
22K	185	75	150	158	87	M6	9.0																																																																																																																																																																																																												
30K	185	75	150	168	87	M6	9.7																																																																																																																																																																																																												
Model	W	W1	H	D	D1	d	Mass (kg)																																																																																																																																																																																																												
400V	H0.4K	135	120	115	64	45	M4	1.5																																																																																																																																																																																																											
	H0.75K	135	120	115	64	45	M4	1.5																																																																																																																																																																																																											
	H1.5K	135	120	115	64	45	M4	1.5																																																																																																																																																																																																											
	H2.2K	135	120	115	64	45	M4	1.5																																																																																																																																																																																																											
	H3.7K	135	120	115	74	57	M4	2.5																																																																																																																																																																																																											
	H5.5K	160	145	150	76	55	M4	3.5																																																																																																																																																																																																											
	H7.5K	160	145	150	96	75	M4	5.0																																																																																																																																																																																																											
	H11K	160	145	146	96	75	M4	6.0																																																																																																																																																																																																											
	H15K	220	200	195	105	70	M5	9.0																																																																																																																																																																																																											
	H18.5K	220	200	212	155	70	M5	9.0																																																																																																																																																																																																											
	H22K	220	200	212	155	70	M5	9.5																																																																																																																																																																																																											
	H30K	220	200	212	153	75	M5	11																																																																																																																																																																																																											

Name (model)

Specification and structure

Improves the power factor and reduces the harmonic current at the input side.

- Selection method
 - Select a DC reactor according to the applied motor capacity. (Select it according to the motor capacity even if the capacity is smaller than the inverter capacity.) (Refer to **page 131**)
- Connection diagram
 - Connect a DC reactor to the inverter terminals P1 and P. Remove the jumper across terminals P1 and P. If the jumper is left attached, no power factor improvement can be obtained.
 - The connection cable between the reactor and the inverter should be as short as possible (5m or less).

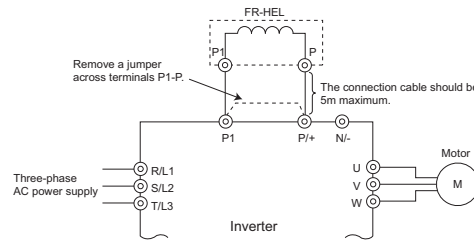

- Outline dimension (Unit: mm)

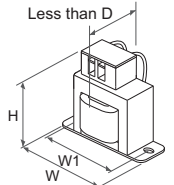

FR-HEL-0.4K to 2.2K
FR-HEL-H0.4K

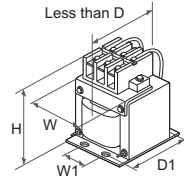

FR-HEL-3.7K to 30K
FR-HEL-H0.75K to H30K

DC reactor
(for power supply
coordination)
FR-HEL-(H)□K





Model	W	W1	H	D	D1	d	Mass (kg)
200V	0.4K	70	60	71	61	—	M4 0.34
	0.75K	85	74	81	61	—	M4 0.5
	1.5K	85	74	81	70	—	M4 0.7
	2.2K	85	74	81	70	—	M4 0.8
	3.7K	77	55	92	82	56	M4 1.4
	5.5K	77	55	92	92	66	M4 1.7
	7.5K	86	60	122	98	73	M4 2.3
	11K	105	64	138	112	78	M6 3.1
	15K	105	64	142	115	83	M6 3.8
	18.5K	105	64	93	165	93	M6 4.1
	22K	105	64	93	175	103	M6 4.8
	30K	114	72	100	200	100	M6 6.7

Model	W	W1	H	D	D1	d	Mass (kg)
400V	H0.4K	90	75	77	60	—	M5 0.6
	H0.75K	66	50	100	70	48	M4 0.85
	H1.5K	66	50	100	80	54	M4 1
	H2.2K	76	50	110	80	54	M4 1.3
	H3.7K	86	55	128	95	69	M4 2.3
	H5.5K	96	60	136	100	75	M5 3
	H7.5K	96	60	136	105	80	M5 3.5
	H11K	105	75	137	110	85	M5 4.5
	H15K	105	75	152	125	95	M5 5
	H18.5K	114	75	162	120	80	M5 5
	H22K	133	90	180	120	75	M5 6
	H30K	133	90	180	120	80	M5 6.5

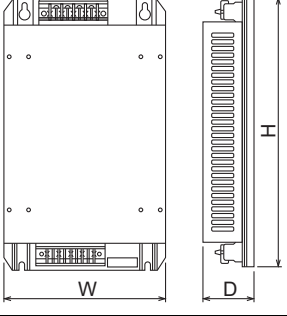
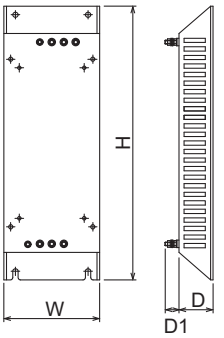
- The size of the cables used should be equal to or larger than that of the power supply cables (R/L1, S/L2, T/L3). (Refer to **page 122**)
- Approximately 93% of the power factor improving effect can be obtained (94.4% when calculated with 1 power factor for the fundamental wave according to the Architectural Standard Specifications (Electrical Installation) supervised by the Ministry of Land, Infrastructure, Transport and Tourism of Japan).
- This is a sample outline dimension drawing. The shape differs by the model. W1 and D1 indicate distances between installation holes. The installation hole size is indicated by d.
- When installing a DC reactor (FR-HEL), install in the orientation shown below.
(H)55K or lower: Horizontal installation or vertical installation
(H)75K or higher: Horizontal installation
- Keep enough clearance around the reactor because it heats up.
(Keep a clearance of minimum 10cm each on top and bottom and minimum 5cm each on right and left regardless of the installation orientation.)
A DC reactor cannot be connected to the single-phase 100 V power input models.

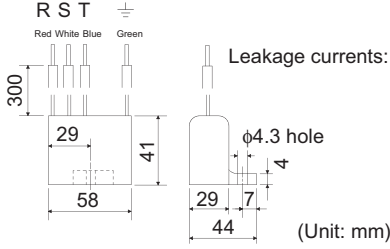
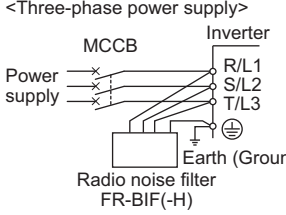
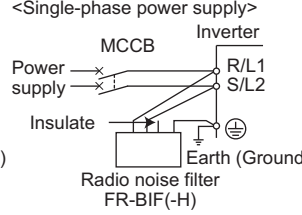
Name (model)	Specification and structure								
<p>EMC Directive compliant EMC filter SF, FR-E5NF, FR-S5NFSA</p> <p>EMC compliant EMC filter installation attachment FR-A5AT03, FR-AAT02, FR-E5T(-02)</p>	<p>• The EMC compliant EMC filter (EN 61800-3 2nd Environment Category C3) is a filter compliant with the EU EMC Directive (EN61800-3 2nd Environment Category C3).</p> <div style="text-align: center;">  </div>								
	EMC filter Model	Applicable inverter model	Intercompatibility attachment *1	Outline dimension (Unit: mm)			Mass (kg)	Leakage current (mA) *2 (reference value)	Loss (W)
				W	H	D			
	SF1306	FR-E820-0.1K to 1.5K	-	110	200	36.5	0.7	10	7.3
	SF1309	FR-E820-2.2K	FR-E5T or FR-E7AT03	200	282	57	2.1	15	15
		FR-E820-3.7K	FR-E8AT03+FR-E5T						
		FR-E820S-2.2K	FR-E7AT03						
	SF1320	FR-E820S-0.1K to 0.4K	-	70	168	30.5	0.4	10	2.7
	SF1321	FR-E820S-0.75K	-	110	168	36.5	0.6	10	3.8
	FR-E5NF-H0.75K	FR-E840-0.4K, 0.75K	-	140	210	46	1.1	22.6	5.5
	FR-E5NF-H3.7K	FR-E840-1.5K to 3.7K	-	140	210	46	1.2	44.5	8
	FR-E5NF-H7.5K	FR-E840-5.5K, 7.5K	-	220	210	47	2	68.4	15
	FR-S5NFSA-0.75K	FR-E810W-0.1K to 0.4K	-	70	168	35	0.5	4.5	1.74
	FR-S5NFSA-1.5K	FR-E820S-1.5K	-	110	168	35	0.7	9.5	8.55
		FR-E810W-0.75K	-						
<div style="text-align: center;">  </div>									
EMC filter Model	Applicable inverter model	Intercompatibility attachment *1	Outline dimension (Unit: mm)				Mass (kg)	Leakage current (mA) *2 (reference value)	Loss (W)
			W	H	D	D1			
SF1260	FR-E820-5.5K, 7.5K	FR-E5T-02	222	468	80	39	5	440	118
	FR-E820-11K	FR-A5AT03							
SF1261	FR-E820-15K	FR-AAT02	253	600	86	38	9.3	71	37
SF1262	FR-E820-18.5K, 22K	*3	303	650	86	47	11	71	78
SF1175	FR-E840-11K, 15K	FR-AAT02	253	530	60	35	4.7	76	56
SF1176	FR-E840-18.5K, 22K	*3	303	600	60	38	5.9	108	71
<p>*1 Depth is 12mm deeper when an intercompatibility attachment is installed.</p> <p>*2 Leakage current for one phase of three-phase three-wire star-connection power supply. Leakage current for all phases of three-phase three-wire delta-connection power supply is three times greater than the indicated value.</p> <p>*3 The noise filter cannot be installed to the back of the inverter. Install it to the side of the inverter.</p> <p>This is a sample outline dimension drawing. The shape differs by the model.</p>									
<p>• Countermeasures for leakage current</p> <p>Take the following actions to prevent malfunction of peripheral devices or an electric shock caused by leakage current.</p> <p>(a) Earth (ground) the EMC filter before connecting the power supply. When doing so, confirm that earthing (grounding) is securely performed through the earthing (grounding) part of the enclosure.</p> <p>(b) Select an appropriate earth leakage circuit breaker or an earth leakage relay by considering leakage current of the EMC filter. Note that earth leakage circuit breaker may not be used in some cases such as when leakage current of the EMC filter is too large. In that case, use an earth leakage relay with high sensitivity. When both of earth leakage circuit breaker and earth leakage relay cannot be used, securely earth (ground) as explained in (a).</p>									

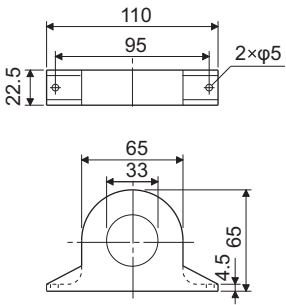
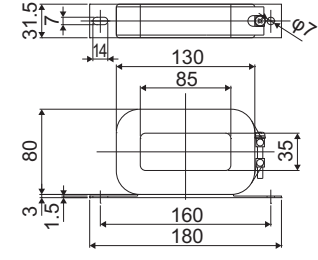
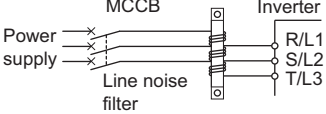
Name (model)	Specification and structure
<p>Radio noise filter FR-BIF(H)</p> 	<p>• Outline dimension</p>  <p>Leakage currents: 4mA</p> <p>(Unit: mm)</p> <p><Three-phase power supply></p>  <p><Single-phase power supply></p>  <p>(a) Cannot be connected to the inverter output side. (b) The wire should be cut as short as possible, and connected to the inverter terminal block. (c) To use the radio noise filter (FR-BIF) for the single-phase input model, ensure the insulation of the T-phase before connecting the filter to the input side of the inverter.</p>
<p>Line noise filter FR-BSF01, FR-BLF</p> 	<p>Install an EMC filter (ferrite core) to reduce the electromagnetic noise generated from the inverter. Effective in the range from about 0.5 MHz to 5 MHz.</p> <p>• Outline dimension (Unit: mm)</p> <p>FR-BSF01</p>  <p>FR-BLF</p>  <p>(a) Wind each phase for three times (4T) in the same direction. (The greater the number of turns, the more effective result is obtained.) When using several line noise filters to make 4T or more, wind the phases (cables) together. Do not use a different line noise filter for different phases. (b) When the cables are too thick to be wound, run each cable (phase) through four or more filters installed in series in one direction. (c) The filter can be used in the same way as the output side. When using filters at the output side, do not wind the cable more than 3 times (4T) for each filter because the filter may overheat. (d) A thick cable of 38 mm² or more is not applicable to the FR-BSF01. Use FR-BLF for a larger diameter cable. (e) Do not wind the earthing (grounding) cable.</p> 

Name (model)

Specification and structure

- Using the option, the inverter may conform to the Japanese guideline for reduction of harmonic emission.
- The option is available for three-phase 200V/400V class inverters with 0.4K to 15K capacity.

• Specification

• Three-phase 200V pow input model

Model FR-BFP2-□□K	0.4	0.75	1.5	2.2	3.7	5.5	7.5	11	15
Permissible inverter output current (A) *1	2.5	4.2	7	10	16.5	23.8	31.8	45	58
Approximate mass (kg)	1.3	1.4	2.0	2.2	2.8	3.8	4.5	6.7	7.0
Power factor improving reactor	Install a DC reactor on the DC side. 93% to 95% of power supply power factor under 100% load (94.4% *3)								
Noise filter	Common mode choke	Install a ferrite core on the input side.							
	Capacitive filter	About 4mA of capacitor leakage current *2							
Protective structure (JEM 1030)	Open type (IP00)								

• Three-phase 400V power input mode

Model FR-BFP2-H□□K	0.4	0.75	1.5	2.2	3.7	5.5	7.5	11	15
Permissible inverter output current (A) *1	1.2	2.2	3.7	5	8.1	12	16.3	23	29.5
Approximate mass (kg)	1.6	1.7	1.9	2.3	2.6	4.5	5.0	7.0	8.2
Power factor improving reactor	Install a DC reactor on the DC side. 93% to 95% of power supply power factor under 100% load (94.4% *3)								
Noise filter	Common mode choke	Install a ferrite core on the input side.							
	Capacitive filter	About 8mA of capacitor leakage current *2							
Protective structure (JEM 1030)	Open type (IP00)								

- *1 Select a capacity for the load (inverter output) current to be equal to or less than the permissible inverter output current.
- *2 The indicated leakage current is for one phase of the three-phase three-wire star-connection power supply.
- *3 The values in parentheses are calculated by applying 1 power factor to the reference waveform in accordance with the Architectural Standard Specifications (Electrical Installation) supervised by the Ministry of Land, Infrastructure, Transport and Tourism of Japan.)

• Outline dimension (Unit: mm)

<FR-BFP2-0.4K, 0.75K, 1.5K, 2.2K, 3.7K>
<FR-BFP2-H0.4K, H0.75K, H1.5K, H2.2K, H3.7K>

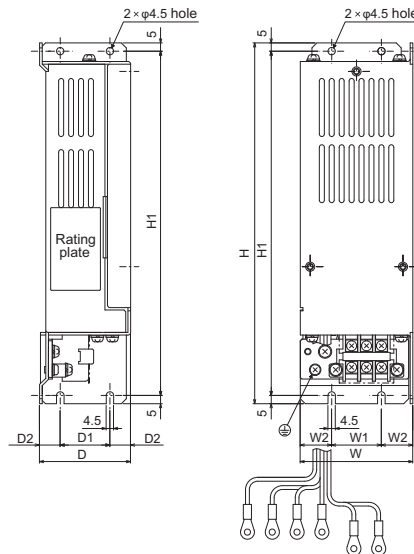

<FR-BFP2-5.5K, 7.5K, 11K, 15K>
<FR-BFP2-H5.5K, H7.5K, H11K, H15K>

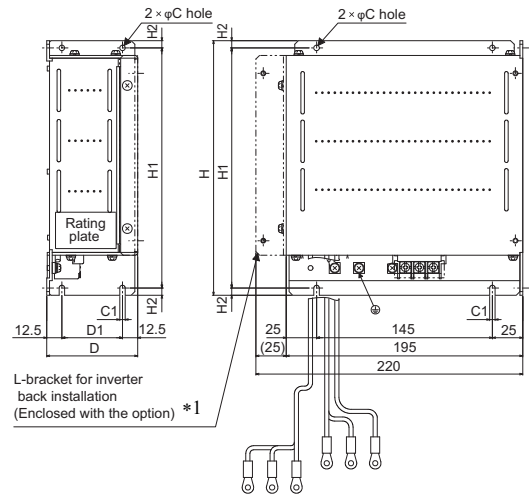

	Capacity	W	W1	W2	H	H1	D	D1	D2
200V	0.4K, 0.75K	68	30	19	218	208	60	30	15
	1.5K, 2.2K	108	55	26.5	188	178	80	55	12.5
	3.7K	170	120	25	188	178	65	40	12.5
400V	H0.4K, H0.75K*1	108	55	26.5	188	178	55	30	12.5
	H1.5K, H2.2K, H3.7K	108	55	26.5	188	178	80	55	12.5

	Capacity	H	H1	H2	D	D1	C	C1	C2
200V	5.5K, 7.5K	210	198	6	75	50	4.5	4.5	5.3
	11K	320	305	7.5	85	60	6	6	5.3
	15K	320	305	7.5	85	60	6	6	6.4
400V	H5.5K, H7.5K	210	198	6	75	50	4.5	4.5	4.3
	H11K	320	305	7.5	85	60	6	6	4.3
	H15K	320	305	7.5	85	60	6	6	6.4

*1 L-bracket is not attached when shipped from the factory but is enclosed with the option. L-bracket is required to install the option to the back of inverter.

- (a) A Filterpack can be installed on the side or rear panel of the inverter. (Rear panel installation is not available for FR-E820-5.5K and 7.5K, and FR-E840-2.2K and 3.7K.)
- (b) Above outline dimension drawings are examples. Dimensions differ by model.

Filterpack
FR-BFP2

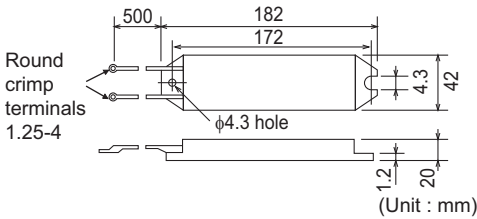
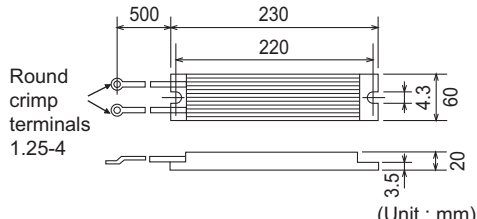

Name (model)	Specification and structure																																				
Brake resistor MRS type, MYS type	<p>• Outline dimension</p> <p>• MRS type</p>  <p>Round crimp terminals 1.25-4</p> <p>φ4.3 hole</p> <p>(Unit : mm)</p> <p>• MYS type</p>  <p>Round crimp terminals 1.25-4</p> <p>(Unit : mm)</p>																																				
	<table border="1"> <thead> <tr> <th colspan="2">Resistor Model</th> <th>Control torque / permissible duty</th> <th>Resistance Value (Ω)</th> <th>Permissible Power (W)</th> <th>Applicable Motor Capacity (kW)</th> </tr> </thead> <tbody> <tr> <td rowspan="6">200V*1</td> <td rowspan="4">MRS type</td> <td>MRS120W200</td> <td rowspan="2">150% torque 3%ED</td> <td>200</td> <td>15</td> <td>0.4</td> </tr> <tr> <td>MRS120W100</td> <td>100</td> <td>30</td> <td>0.75</td> </tr> <tr> <td rowspan="2">MRS120W60</td> <td>100% torque 3%ED</td> <td rowspan="2">60</td> <td rowspan="2">55</td> <td>1.5</td> </tr> <tr> <td>150% torque 3%ED</td> <td>2.2</td> </tr> <tr> <td rowspan="2">MRS120W40</td> <td>100% torque 3%ED</td> <td rowspan="2">40</td> <td rowspan="2">80</td> <td>2.2</td> </tr> <tr> <td>150% torque 3%ED</td> <td>3.7</td> </tr> <tr> <td>MYS type</td> <td>MYS220W50 *2</td> <td>150% torque 3%ED 100% torque 6%ED</td> <td>50/2</td> <td>2×80</td> <td>3.7</td> </tr> </tbody> </table> <p>*1 The option can be connected to the single-phase 100 V class inverters. *2 Two unit in parallel</p> <p>(a) The temperature of the brake resistor becomes 200°C or more depending on the operation frequency, care must be taken for installation and heat dissipation. (b) The brake resistor cannot be used with the 0.1K and 0.2K. (c) Do not remove a jumper across terminal P/+ and P1 except when connecting a DC reactor.</p>	Resistor Model		Control torque / permissible duty	Resistance Value (Ω)	Permissible Power (W)	Applicable Motor Capacity (kW)	200V*1	MRS type	MRS120W200	150% torque 3%ED	200	15	0.4	MRS120W100	100	30	0.75	MRS120W60	100% torque 3%ED	60	55	1.5	150% torque 3%ED	2.2	MRS120W40	100% torque 3%ED	40	80	2.2	150% torque 3%ED	3.7	MYS type	MYS220W50 *2	150% torque 3%ED 100% torque 6%ED	50/2	2×80
Resistor Model		Control torque / permissible duty	Resistance Value (Ω)	Permissible Power (W)	Applicable Motor Capacity (kW)																																
200V*1	MRS type	MRS120W200	150% torque 3%ED	200	15	0.4																															
		MRS120W100		100	30	0.75																															
		MRS120W60	100% torque 3%ED	60	55	1.5																															
			150% torque 3%ED			2.2																															
	MRS120W40	100% torque 3%ED	40	80	2.2																																
		150% torque 3%ED			3.7																																
MYS type	MYS220W50 *2	150% torque 3%ED 100% torque 6%ED	50/2	2×80	3.7																																

Name (model)	Specification and structure																																																																																												
<p data-bbox="199 694 327 750">High-duty brake resistor FR-ABR</p> 	Connecting the option improves the regenerative braking capability of the inverter. • Outline dimension (Unit: mm)																																																																																												
	<table border="1"> <thead> <tr> <th rowspan="2">Brake Resistor Model</th> <th rowspan="2">Permissible Brake Duty</th> <th colspan="4">Outline Dimension</th> <th rowspan="2">Resistance Value (Ω)</th> <th rowspan="2">Approx. Mass (kg)</th> </tr> <tr> <th>W</th> <th>W1</th> <th>D</th> <th>H</th> </tr> </thead> <tbody> <tr> <td rowspan="9">200V*1</td> <td>FR-ABR-0.4K</td> <td>10%</td> <td>140</td> <td>500</td> <td>40</td> <td>21</td> <td>200</td> <td>0.2</td> </tr> <tr> <td>FR-ABR-0.75K</td> <td>10%</td> <td>215</td> <td>500</td> <td>40</td> <td>21</td> <td>100</td> <td>0.4</td> </tr> <tr> <td rowspan="2">FR-ABR-2.2K *2</td> <td>10%</td> <td rowspan="2">240</td> <td rowspan="2">500</td> <td rowspan="2">50</td> <td rowspan="2">26</td> <td rowspan="2">60</td> <td rowspan="2">0.5</td> </tr> <tr> <td>10%</td> </tr> <tr> <td>FR-ABR-3.7K</td> <td>10%</td> <td>215</td> <td>500</td> <td>61</td> <td>33</td> <td>40</td> <td>0.8</td> </tr> <tr> <td>FR-ABR-5.5K</td> <td>10%</td> <td>335</td> <td>500</td> <td>61</td> <td>33</td> <td>25</td> <td>1.3</td> </tr> <tr> <td>FR-ABR-7.5K</td> <td>10%</td> <td>400</td> <td>500</td> <td>80</td> <td>40</td> <td>20</td> <td>2.2</td> </tr> <tr> <td>FR-ABR-11K</td> <td>6%</td> <td>400</td> <td>700</td> <td>100</td> <td>50</td> <td>13</td> <td>3.5</td> </tr> <tr> <td>FR-ABR-15K *3</td> <td>6%</td> <td>300</td> <td>700</td> <td>100</td> <td>50</td> <td>18(×1/2)</td> <td>2.4(×2)</td> </tr> <tr> <td>FR-ABR-22K *4</td> <td>6%</td> <td>400</td> <td>700</td> <td>100</td> <td>50</td> <td>13(×1/2)</td> <td>3.3(×2)</td> </tr> </tbody> </table>	Brake Resistor Model	Permissible Brake Duty	Outline Dimension				Resistance Value (Ω)	Approx. Mass (kg)	W	W1	D	H	200V*1	FR-ABR-0.4K	10%	140	500	40	21	200	0.2	FR-ABR-0.75K	10%	215	500	40	21	100	0.4	FR-ABR-2.2K *2	10%	240	500	50	26	60	0.5	10%	FR-ABR-3.7K	10%	215	500	61	33	40	0.8	FR-ABR-5.5K	10%	335	500	61	33	25	1.3	FR-ABR-7.5K	10%	400	500	80	40	20	2.2	FR-ABR-11K	6%	400	700	100	50	13	3.5	FR-ABR-15K *3	6%	300	700	100	50	18(×1/2)	2.4(×2)	FR-ABR-22K *4	6%	400	700	100	50	13(×1/2)	3.3(×2)						
Brake Resistor Model	Permissible Brake Duty			Outline Dimension						Resistance Value (Ω)	Approx. Mass (kg)																																																																																		
		W	W1	D	H																																																																																								
200V*1	FR-ABR-0.4K	10%	140	500	40	21	200	0.2																																																																																					
	FR-ABR-0.75K	10%	215	500	40	21	100	0.4																																																																																					
	FR-ABR-2.2K *2	10%	240	500	50	26	60	0.5																																																																																					
		10%																																																																																											
	FR-ABR-3.7K	10%	215	500	61	33	40	0.8																																																																																					
	FR-ABR-5.5K	10%	335	500	61	33	25	1.3																																																																																					
	FR-ABR-7.5K	10%	400	500	80	40	20	2.2																																																																																					
	FR-ABR-11K	6%	400	700	100	50	13	3.5																																																																																					
	FR-ABR-15K *3	6%	300	700	100	50	18(×1/2)	2.4(×2)																																																																																					
FR-ABR-22K *4	6%	400	700	100	50	13(×1/2)	3.3(×2)																																																																																						
<table border="1"> <thead> <tr> <th rowspan="2">Brake Resistor Model</th> <th rowspan="2">Permissible Brake Duty</th> <th colspan="4">Outline Dimension</th> <th rowspan="2">Resistance Value (Ω)</th> <th rowspan="2">Approx. Mass (kg)</th> </tr> <tr> <th>W</th> <th>W1</th> <th>D</th> <th>H</th> </tr> </thead> <tbody> <tr> <td rowspan="11">400V</td> <td>FR-ABR-H0.4K</td> <td>10%</td> <td>115</td> <td>500</td> <td>40</td> <td>21</td> <td>1200</td> <td>0.2</td> </tr> <tr> <td>FR-ABR-H0.75K</td> <td>10%</td> <td>140</td> <td>500</td> <td>40</td> <td>21</td> <td>700</td> <td>0.2</td> </tr> <tr> <td>FR-ABR-H1.5K</td> <td>10%</td> <td>215</td> <td>500</td> <td>40</td> <td>21</td> <td>350</td> <td>0.4</td> </tr> <tr> <td>FR-ABR-H2.2K</td> <td>10%</td> <td>240</td> <td>500</td> <td>50</td> <td>26</td> <td>250</td> <td>0.5</td> </tr> <tr> <td>FR-ABR-H3.7K</td> <td>10%</td> <td>215</td> <td>500</td> <td>61</td> <td>33</td> <td>150</td> <td>0.8</td> </tr> <tr> <td>FR-ABR-H5.5K</td> <td>10%</td> <td>335</td> <td>500</td> <td>61</td> <td>33</td> <td>110</td> <td>1.3</td> </tr> <tr> <td>FR-ABR-H7.5K</td> <td>10%</td> <td>400</td> <td>500</td> <td>80</td> <td>40</td> <td>75</td> <td>2.2</td> </tr> <tr> <td>FR-ABR-H11K</td> <td>6%</td> <td>400</td> <td>700</td> <td>100</td> <td>50</td> <td>52</td> <td>3.2</td> </tr> <tr> <td>FR-ABR-H15K *5</td> <td>6%</td> <td>300</td> <td>700</td> <td>100</td> <td>50</td> <td>18(×2)</td> <td>2.4(×2)</td> </tr> <tr> <td rowspan="2">FR-ABR-H22K *6</td> <td rowspan="2">6%</td> <td rowspan="2">450</td> <td rowspan="2">700</td> <td rowspan="2">100</td> <td rowspan="2">50</td> <td rowspan="2">52(×1/2)</td> <td rowspan="2">3.3(×2)</td> </tr> <tr> </tr> </tbody> </table>	Brake Resistor Model	Permissible Brake Duty	Outline Dimension				Resistance Value (Ω)	Approx. Mass (kg)	W	W1	D	H	400V	FR-ABR-H0.4K	10%	115	500	40	21	1200	0.2	FR-ABR-H0.75K	10%	140	500	40	21	700	0.2	FR-ABR-H1.5K	10%	215	500	40	21	350	0.4	FR-ABR-H2.2K	10%	240	500	50	26	250	0.5	FR-ABR-H3.7K	10%	215	500	61	33	150	0.8	FR-ABR-H5.5K	10%	335	500	61	33	110	1.3	FR-ABR-H7.5K	10%	400	500	80	40	75	2.2	FR-ABR-H11K	6%	400	700	100	50	52	3.2	FR-ABR-H15K *5	6%	300	700	100	50	18(×2)	2.4(×2)	FR-ABR-H22K *6	6%	450	700	100	50	52(×1/2)	3.3(×2)
Brake Resistor Model			Permissible Brake Duty	Outline Dimension					Resistance Value (Ω)	Approx. Mass (kg)																																																																																			
	W	W1		D	H																																																																																								
400V	FR-ABR-H0.4K	10%	115	500	40	21	1200	0.2																																																																																					
	FR-ABR-H0.75K	10%	140	500	40	21	700	0.2																																																																																					
	FR-ABR-H1.5K	10%	215	500	40	21	350	0.4																																																																																					
	FR-ABR-H2.2K	10%	240	500	50	26	250	0.5																																																																																					
	FR-ABR-H3.7K	10%	215	500	61	33	150	0.8																																																																																					
	FR-ABR-H5.5K	10%	335	500	61	33	110	1.3																																																																																					
	FR-ABR-H7.5K	10%	400	500	80	40	75	2.2																																																																																					
	FR-ABR-H11K	6%	400	700	100	50	52	3.2																																																																																					
	FR-ABR-H15K *5	6%	300	700	100	50	18(×2)	2.4(×2)																																																																																					
	FR-ABR-H22K *6	6%	450	700	100	50	52(×1/2)	3.3(×2)																																																																																					
<p>*1 The option can be connected to the single-phase 100 V class inverters.</p> <p>*2 For the 1.5K and 2.2K inverter.</p> <p>*3 For the 15K brake resistor, configure so that two 18 Ω resistors are connected in parallel.</p> <p>*4 For the 18.5K and 22K inverter. For the 22K brake resistor, configure so that two 13 Ω resistors are connected in parallel.</p> <p>*5 For the H15K brake resistor, configure so that two 18 Ω resistors are connected in series. FR-ABR-15K is indicated on the resistor. (same resistor as the 200V class 15K)</p> <p>*6 For the H18.5K and H22K inverter. For the H22K brake resistor, configure so that two 52 Ω resistors are connected in parallel.</p> <p>(a) The regenerative brake duty setting should be less than permissible brake duty in the table above.</p> <p>(b) The temperature of the brake resistor becomes 300°C or more depending on the operation frequency, care must be taken for installation and heat dissipation.</p> <p>(c) MYS type resistor can be also used. Note that the permissible brake duty.</p> <p>(d) The brake resistor cannot be used with the 0.1K and 0.2K.</p> <p>(e) Do not remove a jumper across terminal P/+ and P1 except when connecting a DC reactor.</p>																																																																																													

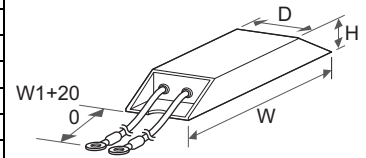

Brake unit
FR-BU2
Resistor unit
FR-BR
Discharging resistor
GZG type, GRZG type

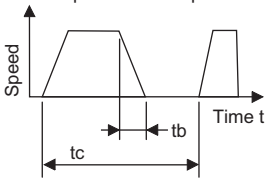
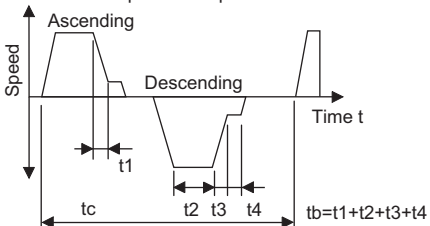
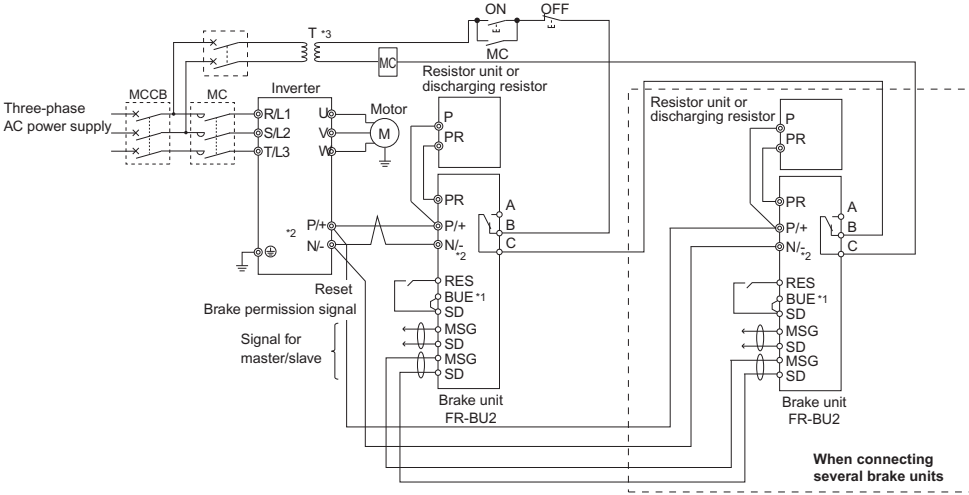
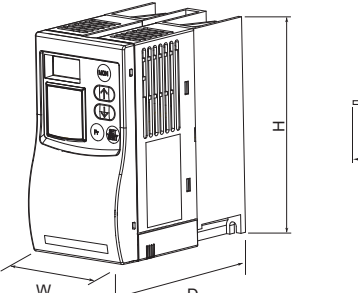
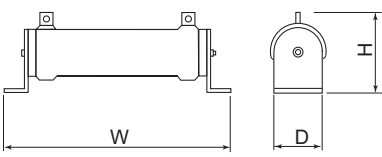
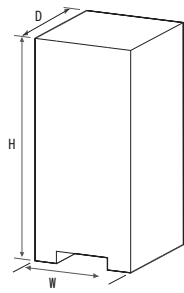

Name (model)	Specification and structure																																																																																																																																																																																																																																																						
	<p>Provides a braking capability greater than that is provided by an external brake resistor. This option can also be connected to the inverters without built-in brake transistors. Three types of discharging resistors are available. Make a selection according to the required braking torque.</p> <p>• Specification [Brake unit]</p> <table border="1"> <thead> <tr> <th rowspan="2">Model: FR-BU2-[]</th> <th colspan="5">200V*1</th> <th colspan="3">400V</th> </tr> <tr> <th>1.5K</th> <th>3.7K</th> <th>7.5K</th> <th>15K</th> <th>30K</th> <th>H7.5K</th> <th>H15K</th> <th>H30K</th> </tr> </thead> <tbody> <tr> <td>Applicable motor capacity</td> <td colspan="8">The applicable capacity differs by the braking torque and the operation rate (%ED).</td> </tr> <tr> <td>Connected brake resistor</td> <td colspan="8">GRZG type, FR-BR, MT-BR5 (For the combination, refer to the table below.)</td> </tr> <tr> <td>Multiple (parallel) driving</td> <td colspan="8">Max. 10 units (However, the torque is limited by the permissible current of the connected inverter.)</td> </tr> <tr> <td>Approximate mass (kg)</td> <td>0.9</td> <td>0.9</td> <td>0.9</td> <td>0.9</td> <td>1.4</td> <td>0.9</td> <td>0.9</td> <td>1.4</td> </tr> </tbody> </table> <p>[Discharging resistor]</p> <table border="1"> <thead> <tr> <th rowspan="2">Model: GRZG type *2</th> <th colspan="4">200V</th> <th colspan="3">400V</th> </tr> <tr> <th>GZG300W-50Ω (1 unit)</th> <th>GRZG200-10Ω (3 units)</th> <th>GRZG300-5Ω (4 units)</th> <th>GRZG400-2Ω (6 units)</th> <th>GRZG200-10Ω (3 units)</th> <th>GRZG300-5Ω (4 units)</th> <th>GRZG400-2Ω (6 units)</th> </tr> </thead> <tbody> <tr> <td>Number of connectable units</td> <td>1 unit</td> <td>3 in series (1 set)</td> <td>4 in series (1 set)</td> <td>6 in series (1 set)</td> <td>6 in series (2 sets)</td> <td>8 in series (2 sets)</td> <td>12 in series (2 sets)</td> </tr> <tr> <td>Discharging resistor combined resistance (Ω)</td> <td>50</td> <td>30</td> <td>20</td> <td>12</td> <td>60</td> <td>40</td> <td>24</td> </tr> <tr> <td>Continuous operation permissible power (W)</td> <td>100</td> <td>300</td> <td>600</td> <td>1200</td> <td>600</td> <td>1200</td> <td>2400</td> </tr> </tbody> </table> <p>[Resistor unit]</p> <table border="1"> <thead> <tr> <th rowspan="2">Model: FR-BR-[]</th> <th colspan="2">200 V</th> <th colspan="2">400 V</th> </tr> <tr> <th>15K</th> <th>30K</th> <th>H15K</th> <th>H30K</th> </tr> </thead> <tbody> <tr> <td>Discharging resistor combined resistance (Ω)</td> <td>8</td> <td>4</td> <td>32</td> <td>16</td> </tr> <tr> <td>Continuous operation permissible power (W)</td> <td>990</td> <td>1990</td> <td>990</td> <td>1990</td> </tr> <tr> <td>Approximate mass (kg)</td> <td>15</td> <td>30</td> <td>15</td> <td>30</td> </tr> </tbody> </table> <p>*1 The option can be connected to the single-phase 100 V class inverters. *2 The 1 set contains the number of units in the parentheses. For the 400 V class, 2 sets are required.</p> <p>• Combination between the brake unit and the resistor unit</p> <table border="1"> <thead> <tr> <th rowspan="3">Brake unit model</th> <th colspan="3">Discharging resistor model or resistor unit model</th> </tr> <tr> <th colspan="2">GRZG type</th> <th rowspan="2">FR-BR</th> </tr> <tr> <th>Model *1</th> <th>Number of connectable units</th> </tr> </thead> <tbody> <tr> <td rowspan="5">200V</td> <td>FR-BU2-1.5K</td> <td>GZG 300W-50Ω (1 unit)</td> <td>1 unit</td> <td>-</td> </tr> <tr> <td>FR-BU2-3.7K</td> <td>GRZG 200-10Ω (3 units)</td> <td>3 in series (1 set)</td> <td>-</td> </tr> <tr> <td>FR-BU2-7.5K</td> <td>GRZG 300-5Ω (4 units)</td> <td>4 in series (1 set)</td> <td>-</td> </tr> <tr> <td>FR-BU2-15K</td> <td>GRZG 400-2Ω (6 units)</td> <td>6 in series (1 set)</td> <td>FR-BR-15K</td> </tr> <tr> <td>FR-BU2-30K</td> <td>-</td> <td>-</td> <td>FR-BR-30K</td> </tr> <tr> <td rowspan="3">400V</td> <td>FR-BU2-H7.5K</td> <td>GRZG 200-10Ω (3 units)</td> <td>6 in series (2 sets)</td> <td>-</td> </tr> <tr> <td>FR-BU2-H15K</td> <td>GRZG 300-5Ω (4 units)</td> <td>8 in series (2 sets)</td> <td>FR-BR-H15K</td> </tr> <tr> <td>FR-BU2-H30K</td> <td>GRZG 400-2Ω (6 units)</td> <td>12 in series (2 sets)</td> <td>FR-BR-H30K</td> </tr> </tbody> </table> <p>*1 The 1 set contains the number of units in the parentheses. For the 400 V class, 2 sets are required.</p> <p>• Selection method [GRZG type] The maximum temperature rise of the discharging resistors is about 200°C. Use heat-resistant wires to perform wiring, and make sure that they will not come in contact with resistors. Do not touch the discharging resistor while the power is ON or for about 10 minutes after the power supply turns OFF. Doing so may cause an electric shock</p> <table border="1"> <thead> <tr> <th rowspan="2">Power supply voltage</th> <th rowspan="2">Braking torque</th> <th colspan="8">Motor capacity (kW)</th> </tr> <tr> <th>0.4</th> <th>0.75</th> <th>1.5</th> <th>2.2</th> <th>3.7</th> <th>5.5</th> <th>7.5</th> <th>11</th> <th>15</th> </tr> </thead> <tbody> <tr> <td rowspan="2">200V</td> <td>50% 30s</td> <td colspan="3">FR-BU2-1.5K</td> <td colspan="2">FR-BU2-3.7K</td> <td colspan="2">FR-BU2-7.5K</td> <td colspan="2">FR-BU2-15K</td> </tr> <tr> <td>100% 30s</td> <td colspan="2">FR-BU2-1.5K</td> <td colspan="2">FR-BU2-3.7K</td> <td colspan="2">FR-BU2-7.5K</td> <td colspan="2">FR-BU2-15K</td> <td>2×FR-BU2-15K *1</td> </tr> <tr> <td rowspan="2">400V</td> <td>50% 30s</td> <td colspan="4">-*2</td> <td colspan="3">FR-BU2-H7.5K</td> <td colspan="2">FR-BU2-H15K</td> </tr> <tr> <td>100% 30s</td> <td colspan="4">-*2</td> <td colspan="2">FR-BU2-H7.5K</td> <td colspan="2">FR-BU2-H15K</td> <td colspan="1">FR-BU2-H30K</td> </tr> </tbody> </table> <table border="1"> <thead> <tr> <th rowspan="2">Power supply voltage</th> <th rowspan="2">Braking torque</th> <th colspan="3">Motor capacity (kW)</th> </tr> <tr> <th>18.5</th> <th>22</th> <th>30</th> </tr> </thead> <tbody> <tr> <td rowspan="2">200V</td> <td>50% 30s</td> <td colspan="3">2×FR-BU2-15K *1</td> </tr> <tr> <td>100% 30s</td> <td colspan="2">3×FR-BU2-15K *1</td> <td>4×FR-BU2-15K *1</td> </tr> <tr> <td rowspan="2">400V</td> <td>50% 30s</td> <td colspan="3">FR-BU2-H30K</td> </tr> <tr> <td>100% 30s</td> <td colspan="3">2×FR-BU2-H30K *1</td> </tr> </tbody> </table> <p>*1 The number next to the model name indicates the number of connectable units in parallel. *2 The inverter for 400V class 1.5K or lower cannot be used in combination with a brake unit. To use in combination with a brake unit, use the inverter of 2.2K or higher.</p>	Model: FR-BU2-[]	200V*1					400V			1.5K	3.7K	7.5K	15K	30K	H7.5K	H15K	H30K	Applicable motor capacity	The applicable capacity differs by the braking torque and the operation rate (%ED).								Connected brake resistor	GRZG type, FR-BR, MT-BR5 (For the combination, refer to the table below.)								Multiple (parallel) driving	Max. 10 units (However, the torque is limited by the permissible current of the connected inverter.)								Approximate mass (kg)	0.9	0.9	0.9	0.9	1.4	0.9	0.9	1.4	Model: GRZG type *2	200V				400V			GZG300W-50Ω (1 unit)	GRZG200-10Ω (3 units)	GRZG300-5Ω (4 units)	GRZG400-2Ω (6 units)	GRZG200-10Ω (3 units)	GRZG300-5Ω (4 units)	GRZG400-2Ω (6 units)	Number of connectable units	1 unit	3 in series (1 set)	4 in series (1 set)	6 in series (1 set)	6 in series (2 sets)	8 in series (2 sets)	12 in series (2 sets)	Discharging resistor combined resistance (Ω)	50	30	20	12	60	40	24	Continuous operation permissible power (W)	100	300	600	1200	600	1200	2400	Model: FR-BR-[]	200 V		400 V		15K	30K	H15K	H30K	Discharging resistor combined resistance (Ω)	8	4	32	16	Continuous operation permissible power (W)	990	1990	990	1990	Approximate mass (kg)	15	30	15	30	Brake unit model	Discharging resistor model or resistor unit model			GRZG type		FR-BR	Model *1	Number of connectable units	200V	FR-BU2-1.5K	GZG 300W-50Ω (1 unit)	1 unit	-	FR-BU2-3.7K	GRZG 200-10Ω (3 units)	3 in series (1 set)	-	FR-BU2-7.5K	GRZG 300-5Ω (4 units)	4 in series (1 set)	-	FR-BU2-15K	GRZG 400-2Ω (6 units)	6 in series (1 set)	FR-BR-15K	FR-BU2-30K	-	-	FR-BR-30K	400V	FR-BU2-H7.5K	GRZG 200-10Ω (3 units)	6 in series (2 sets)	-	FR-BU2-H15K	GRZG 300-5Ω (4 units)	8 in series (2 sets)	FR-BR-H15K	FR-BU2-H30K	GRZG 400-2Ω (6 units)	12 in series (2 sets)	FR-BR-H30K	Power supply voltage	Braking torque	Motor capacity (kW)								0.4	0.75	1.5	2.2	3.7	5.5	7.5	11	15	200V	50% 30s	FR-BU2-1.5K			FR-BU2-3.7K		FR-BU2-7.5K		FR-BU2-15K		100% 30s	FR-BU2-1.5K		FR-BU2-3.7K		FR-BU2-7.5K		FR-BU2-15K		2×FR-BU2-15K *1	400V	50% 30s	-*2				FR-BU2-H7.5K			FR-BU2-H15K		100% 30s	-*2				FR-BU2-H7.5K		FR-BU2-H15K		FR-BU2-H30K	Power supply voltage	Braking torque	Motor capacity (kW)			18.5	22	30	200V	50% 30s	2×FR-BU2-15K *1			100% 30s	3×FR-BU2-15K *1		4×FR-BU2-15K *1	400V	50% 30s	FR-BU2-H30K			100% 30s	2×FR-BU2-H30K *1		
Model: FR-BU2-[]	200V*1					400V																																																																																																																																																																																																																																																	
	1.5K	3.7K	7.5K	15K	30K	H7.5K	H15K	H30K																																																																																																																																																																																																																																															
Applicable motor capacity	The applicable capacity differs by the braking torque and the operation rate (%ED).																																																																																																																																																																																																																																																						
Connected brake resistor	GRZG type, FR-BR, MT-BR5 (For the combination, refer to the table below.)																																																																																																																																																																																																																																																						
Multiple (parallel) driving	Max. 10 units (However, the torque is limited by the permissible current of the connected inverter.)																																																																																																																																																																																																																																																						
Approximate mass (kg)	0.9	0.9	0.9	0.9	1.4	0.9	0.9	1.4																																																																																																																																																																																																																																															
Model: GRZG type *2	200V				400V																																																																																																																																																																																																																																																		
	GZG300W-50Ω (1 unit)	GRZG200-10Ω (3 units)	GRZG300-5Ω (4 units)	GRZG400-2Ω (6 units)	GRZG200-10Ω (3 units)	GRZG300-5Ω (4 units)	GRZG400-2Ω (6 units)																																																																																																																																																																																																																																																
Number of connectable units	1 unit	3 in series (1 set)	4 in series (1 set)	6 in series (1 set)	6 in series (2 sets)	8 in series (2 sets)	12 in series (2 sets)																																																																																																																																																																																																																																																
Discharging resistor combined resistance (Ω)	50	30	20	12	60	40	24																																																																																																																																																																																																																																																
Continuous operation permissible power (W)	100	300	600	1200	600	1200	2400																																																																																																																																																																																																																																																
Model: FR-BR-[]	200 V		400 V																																																																																																																																																																																																																																																				
	15K	30K	H15K	H30K																																																																																																																																																																																																																																																			
Discharging resistor combined resistance (Ω)	8	4	32	16																																																																																																																																																																																																																																																			
Continuous operation permissible power (W)	990	1990	990	1990																																																																																																																																																																																																																																																			
Approximate mass (kg)	15	30	15	30																																																																																																																																																																																																																																																			
Brake unit model	Discharging resistor model or resistor unit model																																																																																																																																																																																																																																																						
	GRZG type		FR-BR																																																																																																																																																																																																																																																				
	Model *1	Number of connectable units																																																																																																																																																																																																																																																					
200V	FR-BU2-1.5K	GZG 300W-50Ω (1 unit)	1 unit	-																																																																																																																																																																																																																																																			
	FR-BU2-3.7K	GRZG 200-10Ω (3 units)	3 in series (1 set)	-																																																																																																																																																																																																																																																			
	FR-BU2-7.5K	GRZG 300-5Ω (4 units)	4 in series (1 set)	-																																																																																																																																																																																																																																																			
	FR-BU2-15K	GRZG 400-2Ω (6 units)	6 in series (1 set)	FR-BR-15K																																																																																																																																																																																																																																																			
	FR-BU2-30K	-	-	FR-BR-30K																																																																																																																																																																																																																																																			
400V	FR-BU2-H7.5K	GRZG 200-10Ω (3 units)	6 in series (2 sets)	-																																																																																																																																																																																																																																																			
	FR-BU2-H15K	GRZG 300-5Ω (4 units)	8 in series (2 sets)	FR-BR-H15K																																																																																																																																																																																																																																																			
	FR-BU2-H30K	GRZG 400-2Ω (6 units)	12 in series (2 sets)	FR-BR-H30K																																																																																																																																																																																																																																																			
Power supply voltage	Braking torque	Motor capacity (kW)																																																																																																																																																																																																																																																					
		0.4	0.75	1.5	2.2	3.7	5.5	7.5	11	15																																																																																																																																																																																																																																													
200V	50% 30s	FR-BU2-1.5K			FR-BU2-3.7K		FR-BU2-7.5K		FR-BU2-15K																																																																																																																																																																																																																																														
	100% 30s	FR-BU2-1.5K		FR-BU2-3.7K		FR-BU2-7.5K		FR-BU2-15K		2×FR-BU2-15K *1																																																																																																																																																																																																																																													
400V	50% 30s	-*2				FR-BU2-H7.5K			FR-BU2-H15K																																																																																																																																																																																																																																														
	100% 30s	-*2				FR-BU2-H7.5K		FR-BU2-H15K		FR-BU2-H30K																																																																																																																																																																																																																																													
Power supply voltage	Braking torque	Motor capacity (kW)																																																																																																																																																																																																																																																					
		18.5	22	30																																																																																																																																																																																																																																																			
200V	50% 30s	2×FR-BU2-15K *1																																																																																																																																																																																																																																																					
	100% 30s	3×FR-BU2-15K *1		4×FR-BU2-15K *1																																																																																																																																																																																																																																																			
400V	50% 30s	FR-BU2-H30K																																																																																																																																																																																																																																																					
	100% 30s	2×FR-BU2-H30K *1																																																																																																																																																																																																																																																					

Name (model)	Specification and structure																																																																					
<p>Brake unit FR-BU2</p> <p>Resistor unit FR-BR</p> <p>Discharging resistor GZG type, GRZG type</p> 	<p>[FR-BR] The maximum temperature rise of the resistor unit is about 100°C. Therefore, use heat-resistant wires (such as glass wires).</p>																																																																					
	<p>%ED at short-time rating when braking torque is 100%</p>		<p>Braking torque (%) at 10%ED in short-time rating of 15 s</p>																																																																			
	<table border="1"> <thead> <tr> <th rowspan="2">Model</th> <th colspan="4">Motor capacity(kW)</th> </tr> <tr> <th>5.5kW</th> <th>7.5kW</th> <th>11kW</th> <th>15kW</th> </tr> </thead> <tbody> <tr> <td rowspan="2">200V</td> <td>FR-BU2-15K</td> <td>80</td> <td>40</td> <td>15</td> <td>10</td> </tr> <tr> <td>FR-BU2-30K</td> <td>-</td> <td>-</td> <td>65</td> <td>30</td> </tr> <tr> <td rowspan="2">400V</td> <td>FR-BU2-H15K</td> <td>80</td> <td>40</td> <td>15</td> <td>10</td> </tr> <tr> <td>FR-BU2-H30K</td> <td>-</td> <td>-</td> <td>65</td> <td>30</td> </tr> </tbody> </table>		Model	Motor capacity(kW)				5.5kW	7.5kW	11kW	15kW	200V	FR-BU2-15K	80	40	15	10	FR-BU2-30K	-	-	65	30	400V	FR-BU2-H15K	80	40	15	10	FR-BU2-H30K	-	-	65	30	<table border="1"> <thead> <tr> <th rowspan="2">Model</th> <th colspan="4">Motor capacity(kW)</th> </tr> <tr> <th>5.5kW</th> <th>7.5kW</th> <th>11kW</th> <th>15kW</th> </tr> </thead> <tbody> <tr> <td rowspan="2">200V</td> <td>FR-BU2-15K</td> <td>Braking torque (%)</td> <td>280</td> <td>200</td> <td>120</td> <td>100</td> </tr> <tr> <td>FR-BU2-30K</td> <td>Braking torque (%)</td> <td>-</td> <td>-</td> <td>260</td> <td>180</td> </tr> <tr> <td rowspan="2">400V</td> <td>FR-BU2-H15K</td> <td>Braking torque (%)</td> <td>280</td> <td>200</td> <td>120</td> <td>100</td> </tr> <tr> <td>FR-BU2-H30K</td> <td>Braking torque (%)</td> <td>-</td> <td>-</td> <td>260</td> <td>180</td> </tr> </tbody> </table>		Model	Motor capacity(kW)				5.5kW	7.5kW	11kW	15kW	200V	FR-BU2-15K	Braking torque (%)	280	200	120	100	FR-BU2-30K	Braking torque (%)	-	-	260	180	400V	FR-BU2-H15K	Braking torque (%)	280	200	120	100	FR-BU2-H30K	Braking torque (%)	-	-	260	180
	Model	Motor capacity(kW)																																																																				
		5.5kW	7.5kW	11kW	15kW																																																																	
	200V	FR-BU2-15K	80	40	15	10																																																																
		FR-BU2-30K	-	-	65	30																																																																
	400V	FR-BU2-H15K	80	40	15	10																																																																
		FR-BU2-H30K	-	-	65	30																																																																
	Model	Motor capacity(kW)																																																																				
5.5kW		7.5kW	11kW	15kW																																																																		
200V	FR-BU2-15K	Braking torque (%)	280	200	120	100																																																																
	FR-BU2-30K	Braking torque (%)	-	-	260	180																																																																
400V	FR-BU2-H15K	Braking torque (%)	280	200	120	100																																																																
	FR-BU2-H30K	Braking torque (%)	-	-	260	180																																																																
<p>Regeneration duty factor (operation frequency)%ED = $\frac{tb}{tc} \times 100$ $tb < 15s$ (continuous operation time)</p>																																																																						
<p>Example 1 Travel operation</p> 		<p>Example 2 Lift operation</p> 																																																																				
<p>• Connection diagram</p>																																																																						
 <p style="text-align: right;">When connecting several brake units</p>																																																																						
<p>*1 A jumper is connected across BUE and SD in the initial status. *2 Connect the inverter terminals (P/+, N/-) and brake unit (FR-BU2) terminals so that their terminal symbols match with each other. Incorrect connection will damage the inverter. Do not remove a jumper across terminal P/+ and P1 except when connecting a DC reactor. *3 When the power supply is 400V class, install a step-down transformer.</p>																																																																						
<p>• Outline dimension (Unit: mm)</p>																																																																						
<p><FR-BU2L></p> 		<p><GZG,GRZG></p> 		<p><FR-BR></p> 																																																																		
<table border="1"> <thead> <tr> <th>Model</th> <th>W</th> <th>H</th> <th>D</th> </tr> </thead> <tbody> <tr> <td>FR-BU2-1.5K to 15K</td> <td>68</td> <td>128</td> <td>132.5</td> </tr> <tr> <td>FR-BU2-30K</td> <td>108</td> <td>128</td> <td>129.5</td> </tr> <tr> <td>FR-BU2-H7.5K, H15K</td> <td>68</td> <td>128</td> <td>132.5</td> </tr> <tr> <td>FR-BU2-H30K</td> <td>108</td> <td>128</td> <td>129.5</td> </tr> </tbody> </table>		Model	W	H	D	FR-BU2-1.5K to 15K	68	128	132.5	FR-BU2-30K	108	128	129.5	FR-BU2-H7.5K, H15K	68	128	132.5	FR-BU2-H30K	108	128	129.5	<table border="1"> <thead> <tr> <th>Model</th> <th>W</th> <th>H</th> <th>D</th> </tr> </thead> <tbody> <tr> <td>GZG300W</td> <td>335</td> <td>78</td> <td>40</td> </tr> <tr> <td>GRZG200</td> <td>306</td> <td>55</td> <td>26</td> </tr> <tr> <td>GRZG300</td> <td>334</td> <td>79</td> <td>40</td> </tr> <tr> <td>GRZG400</td> <td>411</td> <td>79</td> <td>40</td> </tr> </tbody> </table>		Model	W	H	D	GZG300W	335	78	40	GRZG200	306	55	26	GRZG300	334	79	40	GRZG400	411	79	40	<table border="1"> <thead> <tr> <th>Model</th> <th>W</th> <th>H</th> <th>D</th> </tr> </thead> <tbody> <tr> <td>FR-BR-15K</td> <td>170</td> <td>450</td> <td>220</td> </tr> <tr> <td>FR-BR-30K</td> <td>340</td> <td>600</td> <td>220</td> </tr> <tr> <td>FR-BR-H15K</td> <td>170</td> <td>450</td> <td>220</td> </tr> <tr> <td>FR-BR-H30K</td> <td>340</td> <td>600</td> <td>220</td> </tr> </tbody> </table>		Model	W	H	D	FR-BR-15K	170	450	220	FR-BR-30K	340	600	220	FR-BR-H15K	170	450	220	FR-BR-H30K	340	600	220					
Model	W	H	D																																																																			
FR-BU2-1.5K to 15K	68	128	132.5																																																																			
FR-BU2-30K	108	128	129.5																																																																			
FR-BU2-H7.5K, H15K	68	128	132.5																																																																			
FR-BU2-H30K	108	128	129.5																																																																			
Model	W	H	D																																																																			
GZG300W	335	78	40																																																																			
GRZG200	306	55	26																																																																			
GRZG300	334	79	40																																																																			
GRZG400	411	79	40																																																																			
Model	W	H	D																																																																			
FR-BR-15K	170	450	220																																																																			
FR-BR-30K	340	600	220																																																																			
FR-BR-H15K	170	450	220																																																																			
FR-BR-H30K	340	600	220																																																																			

Name (model)	Specification and structure																																																																																																																																																																																																																																																																																																																														
	<p>One inverter can handle harmonic suppression and power regeneration. Functions that match the application can be selected by combining the inverter/converter with the dedicated reactor FR-XCB (box-type) or FR-XCL/FR-XCG.</p> <p>• Combination</p> <p><<Combination matrix of FR-XCL and FR-XC(-PWM)>></p> <table border="1"> <thead> <tr> <th>Dedicated standalone reactor</th> <th colspan="2">Multifunction regeneration converter</th> </tr> <tr> <th>FR-XCL-[] FR-XCG-[]</th> <th>FR-XC-[]</th> <th>FR-XC-[]-PWM *1</th> </tr> </thead> <tbody> <tr><td>7.5K</td><td>7.5K</td><td>-</td></tr> <tr><td>11K</td><td>11K</td><td>-</td></tr> <tr><td>15K</td><td>15K</td><td>-</td></tr> <tr><td>22K</td><td>22K</td><td>18.5K</td></tr> <tr><td>30K</td><td>30K</td><td>22K</td></tr> <tr><td>37K</td><td>37K</td><td>37K</td></tr> <tr><td>55K</td><td>55K</td><td>55K</td></tr> <tr><td>H7.5K</td><td>H7.5K</td><td>-</td></tr> <tr><td>H11K</td><td>H11K</td><td>-</td></tr> <tr><td>H15K</td><td>H15K</td><td>-</td></tr> <tr><td>H22K</td><td>H22K</td><td>H18.5K</td></tr> <tr><td>H30K</td><td>H30K</td><td>H22K</td></tr> <tr><td>H37K</td><td>H37K</td><td>H37K</td></tr> <tr><td>H55K</td><td>H55K</td><td>H55K</td></tr> <tr><td>H75K</td><td>50°C rating H75K</td><td>50°C rating H75K</td></tr> <tr><td>H90K</td><td>40°C rating H75K</td><td>40°C rating H75K</td></tr> </tbody> </table> <p><<Combination matrix of FR-MCB and FR-XC>></p> <table border="1"> <thead> <tr> <th>Dedicated contactor box</th> <th>Multifunction regeneration converter</th> </tr> <tr> <th>FR-MCB-H[]</th> <th>FR-XC-[] (-PWM)</th> </tr> </thead> <tbody> <tr> <td>150</td> <td>H75K</td> </tr> </tbody> </table> <p><<Combination matrix of FR-XCCP and FR-XC(-PWM)>></p> <table border="1"> <thead> <tr> <th>Converter installation attachment for enclosure</th> <th>Multifunction regeneration converter</th> </tr> <tr> <th>FR-XCCP[]</th> <th>FR-XC-[]</th> </tr> </thead> <tbody> <tr> <td rowspan="2">01</td> <td>(H) 7.5K</td> </tr> <tr> <td>(H) 11K</td> </tr> <tr> <td rowspan="2">02</td> <td>(H) 15K</td> </tr> <tr> <td>(H) 22K</td> </tr> <tr> <td rowspan="3">03</td> <td>(H) 30K</td> </tr> <tr> <td>(H) 18.5K-PWM</td> </tr> <tr> <td>(H) 22K-PWM</td> </tr> </tbody> </table> <p><<Combination matrix of FR-XCCU and FR-XC(-PWM)>></p> <table border="1"> <thead> <tr> <th>IP20 compatible attachment</th> <th>Multifunction regeneration converter</th> </tr> <tr> <th>FR-XCCU[]</th> <th>FR-XC-[] (-PWM)</th> </tr> </thead> <tbody> <tr> <td rowspan="2">01</td> <td>37K</td> </tr> <tr> <td>H55K</td> </tr> <tr> <td>02</td> <td>55K</td> </tr> <tr> <td>03</td> <td>H37K</td> </tr> </tbody> </table> <p><<Combination matrix of FR-XCB and FR-XC(-PWM)>></p> <table border="1"> <thead> <tr> <th>Dedicated box-type reactor</th> <th colspan="2">Multifunction regeneration converter</th> </tr> <tr> <th>FR-XCB-[]</th> <th>FR-XC-[] *2</th> <th>FR-XC-[]-PWM</th> </tr> </thead> <tbody> <tr><td>18.5K</td><td>22K</td><td>18.5K</td></tr> <tr><td>22K</td><td>30K</td><td>22K</td></tr> <tr><td>37K</td><td>37K</td><td>37K</td></tr> <tr><td>55K</td><td>55K</td><td>55K</td></tr> <tr><td>H18.5K</td><td>H22K</td><td>H18.5K</td></tr> <tr><td>H22K</td><td>H30K</td><td>H22K</td></tr> <tr><td>H37K</td><td>H37K</td><td>H37K</td></tr> <tr><td>H55K</td><td>H55K</td><td>H55K</td></tr> <tr><td>H75K</td><td>H75K</td><td>H75K</td></tr> </tbody> </table> <p>• Specifications</p> <p><<200V class>></p> <table border="1"> <thead> <tr> <th colspan="2">Model *1</th> <th colspan="7">FR-XC-[]K</th> <th colspan="4">FR-XC-[]K-PWM</th> </tr> <tr> <th rowspan="2">Common bus regeneration mode</th> <th rowspan="2">Applicable inverter capacity (kW)</th> <th>Harmonic suppression</th> <th>7.5</th> <th>11</th> <th>15</th> <th>22</th> <th>30</th> <th>37</th> <th>55</th> <th>18.5</th> <th>22</th> <th>37</th> <th>55</th> </tr> </thead> <tbody> <tr> <td></td> <td></td> <td>Disabled</td> <td>7.5</td> <td>11</td> <td>15</td> <td>22</td> <td>30</td> <td>37</td> <td>55</td> <td>22</td> <td>30</td> <td>37</td> <td>55</td> </tr> <tr> <td></td> <td></td> <td>Enabled</td> <td>-</td> <td>-</td> <td>-</td> <td>18.5</td> <td>22</td> <td>37</td> <td>55</td> <td>18.5</td> <td>22</td> <td>37</td> <td>55</td> </tr> <tr> <td></td> <td>Overload current rating</td> <td></td> <td colspan="7">100% continuous /150% 60 s</td> <td colspan="4">100% continuous /150% 60 s</td> </tr> <tr> <td rowspan="2">Power regeneration mode *2</td> <td>Potential regenerative capacity (kW)</td> <td></td> <td>5.5</td> <td>7.5</td> <td>11</td> <td>18.5</td> <td>22</td> <td>30</td> <td>45</td> <td>18.5</td> <td>22</td> <td>30</td> <td>45</td> </tr> <tr> <td>Overload current rating</td> <td></td> <td colspan="7">100% continuous /150% 60 s</td> <td colspan="4">100% continuous /150% 60 s</td> </tr> <tr> <td rowspan="6">Power source</td> <td rowspan="2">Rated input AC voltage/frequency</td> <td>Disabled</td> <td colspan="7">Three-phase 200 to 240 V 50 Hz/60 Hz</td> <td colspan="4">Three-phase 200 to 240 V 50 Hz/60 Hz</td> </tr> <tr> <td>Enabled</td> <td colspan="7">Three-phase 200 to 230 V 50 Hz/60 Hz *3</td> <td colspan="4">Three-phase 200 to 230 V 50 Hz/60 Hz *4</td> </tr> <tr> <td rowspan="2">Permissible AC voltage fluctuation</td> <td>Disabled</td> <td colspan="7">Three-phase 70 to 264 V 50 Hz/60 Hz</td> <td colspan="4">Three-phase 170 to 264 V 50 Hz/60 Hz</td> </tr> <tr> <td>Enabled</td> <td colspan="7">Three-phase 170 to 253 V 50 Hz/60 Hz</td> <td colspan="4">Three-phase 170 to 253 V 50 Hz/60 Hz</td> </tr> <tr> <td rowspan="2">Permissible frequency fluctuation</td> <td>Disabled</td> <td colspan="7">±5%</td> <td colspan="4">±5%</td> </tr> <tr> <td>Enabled</td> <td colspan="7">±5%</td> <td colspan="4">±5%</td> </tr> <tr> <td colspan="2">Input power factor</td> <td>Enabled</td> <td colspan="7">0.99 or more (when load ratio is 100%)</td> <td colspan="4">0.99 or more (when load ratio is 100%)</td> </tr> <tr> <td colspan="3">Approx. mass (kg) *5</td> <td>5</td> <td>5</td> <td>6</td> <td>10.5</td> <td>10.5</td> <td>28</td> <td>38</td> <td>10.5</td> <td>10.5</td> <td>28</td> <td>38</td> </tr> </tbody> </table>	Dedicated standalone reactor	Multifunction regeneration converter		FR-XCL-[] FR-XCG-[]	FR-XC-[]	FR-XC-[]-PWM *1	7.5K	7.5K	-	11K	11K	-	15K	15K	-	22K	22K	18.5K	30K	30K	22K	37K	37K	37K	55K	55K	55K	H7.5K	H7.5K	-	H11K	H11K	-	H15K	H15K	-	H22K	H22K	H18.5K	H30K	H30K	H22K	H37K	H37K	H37K	H55K	H55K	H55K	H75K	50°C rating H75K	50°C rating H75K	H90K	40°C rating H75K	40°C rating H75K	Dedicated contactor box	Multifunction regeneration converter	FR-MCB-H[]	FR-XC-[] (-PWM)	150	H75K	Converter installation attachment for enclosure	Multifunction regeneration converter	FR-XCCP[]	FR-XC-[]	01	(H) 7.5K	(H) 11K	02	(H) 15K	(H) 22K	03	(H) 30K	(H) 18.5K-PWM	(H) 22K-PWM	IP20 compatible attachment	Multifunction regeneration converter	FR-XCCU[]	FR-XC-[] (-PWM)	01	37K	H55K	02	55K	03	H37K	Dedicated box-type reactor	Multifunction regeneration converter		FR-XCB-[]	FR-XC-[] *2	FR-XC-[]-PWM	18.5K	22K	18.5K	22K	30K	22K	37K	37K	37K	55K	55K	55K	H18.5K	H22K	H18.5K	H22K	H30K	H22K	H37K	H37K	H37K	H55K	H55K	H55K	H75K	H75K	H75K	Model *1		FR-XC-[]K							FR-XC-[]K-PWM				Common bus regeneration mode	Applicable inverter capacity (kW)	Harmonic suppression	7.5	11	15	22	30	37	55	18.5	22	37	55			Disabled	7.5	11	15	22	30	37	55	22	30	37	55			Enabled	-	-	-	18.5	22	37	55	18.5	22	37	55		Overload current rating		100% continuous /150% 60 s							100% continuous /150% 60 s				Power regeneration mode *2	Potential regenerative capacity (kW)		5.5	7.5	11	18.5	22	30	45	18.5	22	30	45	Overload current rating		100% continuous /150% 60 s							100% continuous /150% 60 s				Power source	Rated input AC voltage/frequency	Disabled	Three-phase 200 to 240 V 50 Hz/60 Hz							Three-phase 200 to 240 V 50 Hz/60 Hz				Enabled	Three-phase 200 to 230 V 50 Hz/60 Hz *3							Three-phase 200 to 230 V 50 Hz/60 Hz *4				Permissible AC voltage fluctuation	Disabled	Three-phase 70 to 264 V 50 Hz/60 Hz							Three-phase 170 to 264 V 50 Hz/60 Hz				Enabled	Three-phase 170 to 253 V 50 Hz/60 Hz							Three-phase 170 to 253 V 50 Hz/60 Hz				Permissible frequency fluctuation	Disabled	±5%							±5%				Enabled	±5%							±5%				Input power factor		Enabled	0.99 or more (when load ratio is 100%)							0.99 or more (when load ratio is 100%)				Approx. mass (kg) *5			5	5	6	10.5	10.5	28	38	10.5	10.5	28	38
Dedicated standalone reactor	Multifunction regeneration converter																																																																																																																																																																																																																																																																																																																														
FR-XCL-[] FR-XCG-[]	FR-XC-[]	FR-XC-[]-PWM *1																																																																																																																																																																																																																																																																																																																													
7.5K	7.5K	-																																																																																																																																																																																																																																																																																																																													
11K	11K	-																																																																																																																																																																																																																																																																																																																													
15K	15K	-																																																																																																																																																																																																																																																																																																																													
22K	22K	18.5K																																																																																																																																																																																																																																																																																																																													
30K	30K	22K																																																																																																																																																																																																																																																																																																																													
37K	37K	37K																																																																																																																																																																																																																																																																																																																													
55K	55K	55K																																																																																																																																																																																																																																																																																																																													
H7.5K	H7.5K	-																																																																																																																																																																																																																																																																																																																													
H11K	H11K	-																																																																																																																																																																																																																																																																																																																													
H15K	H15K	-																																																																																																																																																																																																																																																																																																																													
H22K	H22K	H18.5K																																																																																																																																																																																																																																																																																																																													
H30K	H30K	H22K																																																																																																																																																																																																																																																																																																																													
H37K	H37K	H37K																																																																																																																																																																																																																																																																																																																													
H55K	H55K	H55K																																																																																																																																																																																																																																																																																																																													
H75K	50°C rating H75K	50°C rating H75K																																																																																																																																																																																																																																																																																																																													
H90K	40°C rating H75K	40°C rating H75K																																																																																																																																																																																																																																																																																																																													
Dedicated contactor box	Multifunction regeneration converter																																																																																																																																																																																																																																																																																																																														
FR-MCB-H[]	FR-XC-[] (-PWM)																																																																																																																																																																																																																																																																																																																														
150	H75K																																																																																																																																																																																																																																																																																																																														
Converter installation attachment for enclosure	Multifunction regeneration converter																																																																																																																																																																																																																																																																																																																														
FR-XCCP[]	FR-XC-[]																																																																																																																																																																																																																																																																																																																														
01	(H) 7.5K																																																																																																																																																																																																																																																																																																																														
	(H) 11K																																																																																																																																																																																																																																																																																																																														
02	(H) 15K																																																																																																																																																																																																																																																																																																																														
	(H) 22K																																																																																																																																																																																																																																																																																																																														
03	(H) 30K																																																																																																																																																																																																																																																																																																																														
	(H) 18.5K-PWM																																																																																																																																																																																																																																																																																																																														
	(H) 22K-PWM																																																																																																																																																																																																																																																																																																																														
IP20 compatible attachment	Multifunction regeneration converter																																																																																																																																																																																																																																																																																																																														
FR-XCCU[]	FR-XC-[] (-PWM)																																																																																																																																																																																																																																																																																																																														
01	37K																																																																																																																																																																																																																																																																																																																														
	H55K																																																																																																																																																																																																																																																																																																																														
02	55K																																																																																																																																																																																																																																																																																																																														
03	H37K																																																																																																																																																																																																																																																																																																																														
Dedicated box-type reactor	Multifunction regeneration converter																																																																																																																																																																																																																																																																																																																														
FR-XCB-[]	FR-XC-[] *2	FR-XC-[]-PWM																																																																																																																																																																																																																																																																																																																													
18.5K	22K	18.5K																																																																																																																																																																																																																																																																																																																													
22K	30K	22K																																																																																																																																																																																																																																																																																																																													
37K	37K	37K																																																																																																																																																																																																																																																																																																																													
55K	55K	55K																																																																																																																																																																																																																																																																																																																													
H18.5K	H22K	H18.5K																																																																																																																																																																																																																																																																																																																													
H22K	H30K	H22K																																																																																																																																																																																																																																																																																																																													
H37K	H37K	H37K																																																																																																																																																																																																																																																																																																																													
H55K	H55K	H55K																																																																																																																																																																																																																																																																																																																													
H75K	H75K	H75K																																																																																																																																																																																																																																																																																																																													
Model *1		FR-XC-[]K							FR-XC-[]K-PWM																																																																																																																																																																																																																																																																																																																						
Common bus regeneration mode	Applicable inverter capacity (kW)	Harmonic suppression	7.5	11	15	22	30	37	55	18.5	22	37	55																																																																																																																																																																																																																																																																																																																		
				Disabled	7.5	11	15	22	30	37	55	22	30	37	55																																																																																																																																																																																																																																																																																																																
		Enabled	-	-	-	18.5	22	37	55	18.5	22	37	55																																																																																																																																																																																																																																																																																																																		
	Overload current rating		100% continuous /150% 60 s							100% continuous /150% 60 s																																																																																																																																																																																																																																																																																																																					
Power regeneration mode *2	Potential regenerative capacity (kW)		5.5	7.5	11	18.5	22	30	45	18.5	22	30	45																																																																																																																																																																																																																																																																																																																		
	Overload current rating		100% continuous /150% 60 s							100% continuous /150% 60 s																																																																																																																																																																																																																																																																																																																					
Power source	Rated input AC voltage/frequency	Disabled	Three-phase 200 to 240 V 50 Hz/60 Hz							Three-phase 200 to 240 V 50 Hz/60 Hz																																																																																																																																																																																																																																																																																																																					
		Enabled	Three-phase 200 to 230 V 50 Hz/60 Hz *3							Three-phase 200 to 230 V 50 Hz/60 Hz *4																																																																																																																																																																																																																																																																																																																					
	Permissible AC voltage fluctuation	Disabled	Three-phase 70 to 264 V 50 Hz/60 Hz							Three-phase 170 to 264 V 50 Hz/60 Hz																																																																																																																																																																																																																																																																																																																					
		Enabled	Three-phase 170 to 253 V 50 Hz/60 Hz							Three-phase 170 to 253 V 50 Hz/60 Hz																																																																																																																																																																																																																																																																																																																					
	Permissible frequency fluctuation	Disabled	±5%							±5%																																																																																																																																																																																																																																																																																																																					
		Enabled	±5%							±5%																																																																																																																																																																																																																																																																																																																					
Input power factor		Enabled	0.99 or more (when load ratio is 100%)							0.99 or more (when load ratio is 100%)																																																																																																																																																																																																																																																																																																																					
Approx. mass (kg) *5			5	5	6	10.5	10.5	28	38	10.5	10.5	28	38																																																																																																																																																																																																																																																																																																																		
<p>Multifunction regeneration converter FR-XC</p> <p>Dedicated stand-alone reactor FR-XCL/FR-XCG</p> <p>Dedicated box-type reactor FR-XCB</p> 																																																																																																																																																																																																																																																																																																																															

- *1 The harmonic suppression function is pre-enabled in this model. To use the converter with the FR-XCL, change the "9999" setting of **Pr.416 Control method selection** to "0" (harmonic suppression disabled).
- *2 The harmonic suppression function is not pre-enabled in this model. To use the converter with the FR-XCB, change the "9999" setting of **Pr.416 Control method selection** to "1" (harmonic suppression enabled).

Name (model)		Specification and structure															
Multifunction regeneration converter FR-XC Dedicated stand-alone reactor FR-XCL/FR-XCG Dedicated box-type reactor FR-XCB		<<400V class>>															
		Model*1		FR-XC-H[]K								FR-XC-H[]K-PWM					
				Harmonic suppression	7.5	11	15	22	30	37	55	75	18.5	22	37	55	75
		Common bus regeneration mode	Applicable inverter capacity (kW)	Disabled	7.5	11	15	22	30	37	55	75*6	22	30	37	55	75*6
				Enabled	-	-	-	18.5	22	37	55	75*6	18.5	22	37	55	75*6
				Overload current rating	100% continuous /150% 60 s								100% continuous /150% 60 s				
		Power regeneration mode *2	Potential regenerative capacity (kW)	Disabled	5.5	7.5	11	18.5	22	30	45	75*6	18.5	22	30	45	75*6
				Enabled	-	-	-	-	-	-	-	-	-	-	-	-	-
				Overload current rating	100% continuous /150% 60 s								100% continuous /150% 60s				
		Power source	Rated input AC voltage/frequency	Disabled	Three-phase 380 to 500 V 50 Hz/60 Hz								Three-phase 380 to 500 V 50 Hz/60 Hz				
				Enabled	-	-	-	Three-phase 380 to 480 V 50 Hz/60 Hz *3			-		Three-phase 380 to 480 V 50 Hz/60 Hz *4				
			Permissible AC voltage fluctuation	Disabled	Three-phase 323 to 550 V 50 Hz/60 Hz								Three-phase 323 to 550 V 50 Hz/60 Hz				
				Enabled	-	-	-	Three-phase 323 to 506 V 50 Hz/60 Hz			-		Three-phase 323 to 506 V 50 Hz/60 Hz				
			Permissible frequency fluctuation	Disabled	±5%								±5%				
				Enabled	-	-	-	±5%			-		±5%				
Input power factor		Enabled	-	-	-	0.99 or more (when load ratio is 100%)					0.99 or more (when load ratio is 100%)						
Approx. mass (kg) *5			5	5	6	10.5	10.5	28	28	45	10.5	10.5	28	28	45		
		*1	The harmonic suppression function is not pre-enabled in this model.														
		*2	The power regeneration mode is selectable when the harmonic suppression function is disabled.														
		*3	The DC bus voltage is approx. 297 VDC at an input voltage of 200 VAC, approx. 327 VDC at 220 VAC, and approx. 342 VDC at 230 VAC.														
		*4	The DC bus voltage is approx. 594 VDC at an input voltage of 400 VAC, approx. 653 VDC at 440 VAC, and approx. 713 VDC at 480 VAC.														
		*5	Mass of the FR-XC alone.														
		*6	90 kW for the 40°C rating														
		• Connection diagram															
		<<Common bus regeneration mode with harmonic suppression disabled>>															
		*1	Never connect the power supply to terminals R/L1, S/L2, and T/L3 on the inverter. Doing so will damage the inverter and the converter.														
		*2	When the FR-XC is connected, the jumper across terminals P/+ and P1 does not affect the function. (The FR-XC can be connected with the jumper connected.)														
		*3	Connect between the inverter terminal P/+ and the converter terminal P/+ and between the inverter terminal N/- and the converter terminal N/- for polarity consistency. Failure to do so will damage the converter and the inverter.														
		*4	Confirm the correct phase sequence of three-phase current to connect between the reactor and the converter, and between the power supply and terminals R/L1, S/L2, and T/L3. Failure to do so will damage the converter.														
		*5	Be sure to connect the power supply and terminals R/L1, S/L2, and T/L3 of the converter. Operating the inverter without connecting them will damage the converter.														
		*6	Do not connect anything to terminal P4.														
		*7	Assign the X10 signal to any of the input terminals.														
		*8	To use separate power supply for the control circuit, remove each jumper at terminal R1/L11 and terminal S1/L21.														
		*9	Install UL listed fuses on the input side of the reactor to meet the UL/cUL standards (refer to the FR-XC Instruction Manual for information about the fuse).														
		*10	Do not install an MCCB or MC between the reactor and the converter. Doing so disrupts proper operation.														



Name (model)

Specification and structure

Multifunction
regeneration converter
FR-XC
Dedicated stand-alone
reactor
FR-XCL/FR-XCG
Dedicated box-type
reactor
FR-XCB



• Outline dimension (Unit: mm)
This is an example of the outer appearance, which differs depending on the model.
<<Multifunction regeneration converter FR-XC (-PWM)>>

•FR-XC-(H)7.5K, (H)11K, (H)15K

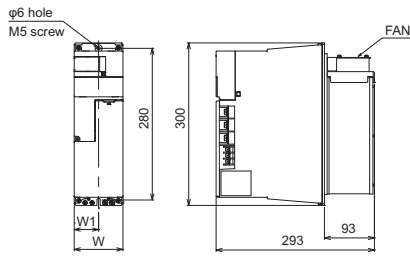

•FR-XC-(H)22K, (H)30K
•FR-XC-(H)18.5K-PWM, (H)22K-PWM

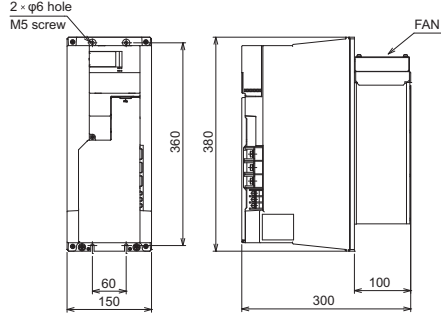

Model	W	W1
FR-XC-(H)7.5K, (H)11K	90	45
FR-XC-(H)15K	120	60

•FR-XC-(H)37K, (H)55K
•FR-XC-(H)37K-PWM, (H)55K-PWM

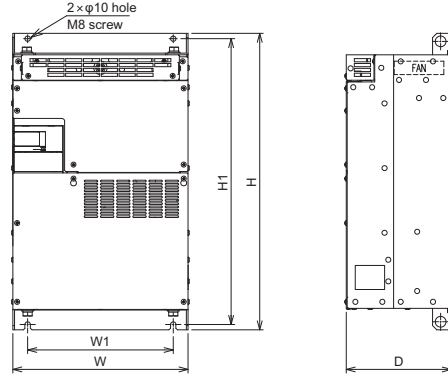

•FR-XC-H75K
•FR-XC-H75K-PWM

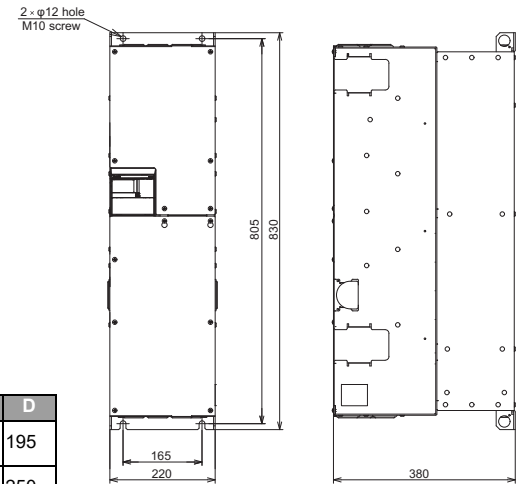

Model	W	W1	H	H1	D
FR-XC-(H)37K, H55K FR-XC-(H)37K-PWM, H55K-PWM	325	270	550	530	195
FR-XC-55K FR-XC-55K-PWM	370	300	620	600	250

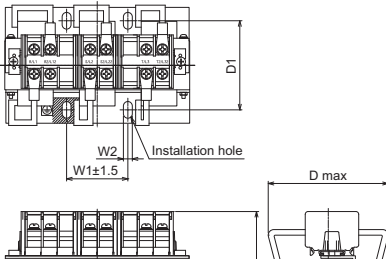
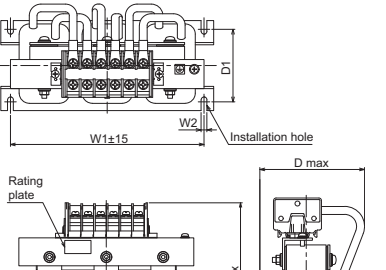
Name (model)	Specification and structure																																																																																											
<p>Multifunction regeneration converter FR-XC</p> <p>Dedicated stand-alone reactor FR-XCL/FR-XCG</p> <p>Dedicated box-type reactor FR-XCB</p> 	<<Dedicated stand-alone reactor FR-XCL>>																																																																																											
	200 V class																																																																																											
	 <table border="1" data-bbox="790 275 1476 510"> <thead> <tr> <th>Model</th> <th>W</th> <th>W1</th> <th>W2</th> <th>H</th> <th>D</th> <th>D1</th> <th>Mounting screw size</th> <th>Terminal screw size</th> <th>Mass (kg)</th> </tr> </thead> <tbody> <tr> <td>FR-XCL-7.5K</td> <td rowspan="2">165</td> <td rowspan="2">55</td> <td rowspan="2">8</td> <td rowspan="2">125</td> <td>120</td> <td>80±2</td> <td rowspan="2">M6</td> <td rowspan="2">M5</td> <td>3.9</td> </tr> <tr> <td>FR-XCL-11K</td> <td>130</td> <td>73±2</td> <td>3.6</td> </tr> <tr> <td>FR-XCL-15K</td> <td rowspan="2">192</td> <td rowspan="2">70</td> <td rowspan="2">10</td> <td rowspan="2">130</td> <td>140</td> <td>100±2</td> <td rowspan="2">M8</td> <td rowspan="2">M6</td> <td>5.5</td> </tr> <tr> <td>FR-XCL-22K</td> <td>150</td> <td>110±2</td> <td>6.3</td> </tr> <tr> <td>FR-XCL-30K</td> <td>240</td> <td>200</td> <td>10</td> <td>150</td> <td>160</td> <td>119±2</td> <td rowspan="2">M8</td> <td rowspan="2">M10</td> <td>10.0</td> </tr> <tr> <td>FR-XCL-37K</td> <td>248</td> <td>225</td> <td>10</td> <td>190</td> <td>240</td> <td>120±5</td> <td>12.0</td> </tr> <tr> <td>FR-XCL-55K</td> <td>250</td> <td>225</td> <td>10</td> <td>190</td> <td>260</td> <td>135±5</td> <td>M8</td> <td>M10</td> <td>15.5</td> </tr> </tbody> </table>											Model	W	W1	W2	H	D	D1	Mounting screw size	Terminal screw size	Mass (kg)	FR-XCL-7.5K	165	55	8	125	120	80±2	M6	M5	3.9	FR-XCL-11K	130	73±2	3.6	FR-XCL-15K	192	70	10	130	140	100±2	M8	M6	5.5	FR-XCL-22K	150	110±2	6.3	FR-XCL-30K	240	200	10	150	160	119±2	M8	M10	10.0	FR-XCL-37K	248	225	10	190	240	120±5	12.0	FR-XCL-55K	250	225	10	190	260	135±5	M8	M10	15.5															
	Model	W	W1	W2	H	D	D1	Mounting screw size	Terminal screw size	Mass (kg)																																																																																		
	FR-XCL-7.5K	165	55	8	125	120	80±2	M6	M5	3.9																																																																																		
	FR-XCL-11K					130	73±2			3.6																																																																																		
	FR-XCL-15K	192	70	10	130	140	100±2	M8	M6	5.5																																																																																		
	FR-XCL-22K					150	110±2			6.3																																																																																		
	FR-XCL-30K	240	200	10	150	160	119±2	M8	M10	10.0																																																																																		
	FR-XCL-37K	248	225	10	190	240	120±5			12.0																																																																																		
FR-XCL-55K	250	225	10	190	260	135±5	M8	M10	15.5																																																																																			
400 V class																																																																																												
<table border="1" data-bbox="790 533 1476 824"> <thead> <tr> <th>Model</th> <th>W</th> <th>W1</th> <th>W2</th> <th>H</th> <th>D</th> <th>D1</th> <th>Mounting screw size</th> <th>Terminal screw size</th> <th>Mass (kg)</th> </tr> </thead> <tbody> <tr> <td>FR-XCL-H7.5K</td> <td rowspan="2">165</td> <td rowspan="2">55</td> <td rowspan="2">8</td> <td rowspan="2">125</td> <td>120</td> <td>73±2</td> <td rowspan="2">M6</td> <td rowspan="2">M5</td> <td>3.7</td> </tr> <tr> <td>FR-XCL-H11K</td> <td>135</td> <td>80±2</td> <td>4.2</td> </tr> <tr> <td>FR-XCL-H15K</td> <td rowspan="2">240</td> <td rowspan="2">70</td> <td rowspan="2">10</td> <td rowspan="2">150</td> <td>150</td> <td>109±2</td> <td rowspan="2">M6</td> <td rowspan="2">M6</td> <td>9.0</td> </tr> <tr> <td>FR-XCL-H22K</td> <td>170</td> <td>129±2</td> <td>12.0</td> </tr> <tr> <td>FR-XCL-H30K</td> <td>220</td> <td>200</td> <td>10</td> <td>190</td> <td>230</td> <td>120±5</td> <td rowspan="2">M8</td> <td rowspan="2">M8</td> <td>12.0</td> </tr> <tr> <td>FR-XCL-H37K</td> <td>250</td> <td>225</td> <td>10</td> <td>190</td> <td>230</td> <td>135±5</td> <td>16.0</td> </tr> <tr> <td>FR-XCL-H75K</td> <td>300</td> <td>270</td> <td>10</td> <td>335</td> <td>200</td> <td>140±2</td> <td>M8</td> <td>M8</td> <td>50.0</td> </tr> <tr> <td>FR-XCL-H90K</td> <td>300</td> <td>270</td> <td>10</td> <td>360</td> <td>210</td> <td>150±2</td> <td>M8</td> <td>M8</td> <td>60.0</td> </tr> </tbody> </table>											Model	W	W1	W2	H	D	D1	Mounting screw size	Terminal screw size	Mass (kg)	FR-XCL-H7.5K	165	55	8	125	120	73±2	M6	M5	3.7	FR-XCL-H11K	135	80±2	4.2	FR-XCL-H15K	240	70	10	150	150	109±2	M6	M6	9.0	FR-XCL-H22K	170	129±2	12.0	FR-XCL-H30K	220	200	10	190	230	120±5	M8	M8	12.0	FR-XCL-H37K	250	225	10	190	230	135±5	16.0	FR-XCL-H75K	300	270	10	335	200	140±2	M8	M8	50.0	FR-XCL-H90K	300	270	10	360	210	150±2	M8	M8	60.0						
Model	W	W1	W2	H	D	D1	Mounting screw size	Terminal screw size	Mass (kg)																																																																																			
FR-XCL-H7.5K	165	55	8	125	120	73±2	M6	M5	3.7																																																																																			
FR-XCL-H11K					135	80±2			4.2																																																																																			
FR-XCL-H15K	240	70	10	150	150	109±2	M6	M6	9.0																																																																																			
FR-XCL-H22K					170	129±2			12.0																																																																																			
FR-XCL-H30K	220	200	10	190	230	120±5	M8	M8	12.0																																																																																			
FR-XCL-H37K	250	225	10	190	230	135±5			16.0																																																																																			
FR-XCL-H75K	300	270	10	335	200	140±2	M8	M8	50.0																																																																																			
FR-XCL-H90K	300	270	10	360	210	150±2	M8	M8	60.0																																																																																			
<<Dedicated stand-alone reactor FR-XCG>>																																																																																												
200 V class																																																																																												
 <table border="1" data-bbox="790 880 1476 1126"> <thead> <tr> <th>Model</th> <th>W</th> <th>W1</th> <th>W2</th> <th>H</th> <th>D</th> <th>D1</th> <th>Mounting screw size</th> <th>Terminal screw size</th> <th>Mass (kg)</th> </tr> </thead> <tbody> <tr> <td>FR-XCG-7.5K</td> <td rowspan="2">220</td> <td rowspan="2">200</td> <td rowspan="2">6</td> <td rowspan="2">185</td> <td>115</td> <td>60±1.5</td> <td rowspan="2">M5</td> <td rowspan="2">M5</td> <td>5</td> </tr> <tr> <td>FR-XCG-11K</td> <td>120</td> <td>75±1.5</td> <td>8</td> </tr> <tr> <td>FR-XCG-15K</td> <td rowspan="2">255</td> <td rowspan="2">225</td> <td rowspan="2">8</td> <td rowspan="2">240</td> <td>130</td> <td>90±1.5</td> <td rowspan="2">M6</td> <td rowspan="2">M6</td> <td>11</td> </tr> <tr> <td>FR-XCG-22K</td> <td>140</td> <td>85±1.5</td> <td>16</td> </tr> <tr> <td>FR-XCG-30K</td> <td rowspan="2">300</td> <td rowspan="2">270</td> <td rowspan="2">10</td> <td rowspan="2">285</td> <td>155</td> <td>100±1.5</td> <td rowspan="2">M8</td> <td rowspan="2">M10</td> <td>20</td> </tr> <tr> <td>FR-XCG-37K</td> <td>180</td> <td>100±1.5</td> <td>25</td> </tr> <tr> <td>FR-XCG-55K</td> <td>300</td> <td>270</td> <td>10</td> <td>285</td> <td>190</td> <td>130±1.5</td> <td>M8</td> <td>M10</td> <td>40</td> </tr> </tbody> </table>											Model	W	W1	W2	H	D	D1	Mounting screw size	Terminal screw size	Mass (kg)	FR-XCG-7.5K	220	200	6	185	115	60±1.5	M5	M5	5	FR-XCG-11K	120	75±1.5	8	FR-XCG-15K	255	225	8	240	130	90±1.5	M6	M6	11	FR-XCG-22K	140	85±1.5	16	FR-XCG-30K	300	270	10	285	155	100±1.5	M8	M10	20	FR-XCG-37K	180	100±1.5	25	FR-XCG-55K	300	270	10	285	190	130±1.5	M8	M10	40																				
Model	W	W1	W2	H	D	D1	Mounting screw size	Terminal screw size	Mass (kg)																																																																																			
FR-XCG-7.5K	220	200	6	185	115	60±1.5	M5	M5	5																																																																																			
FR-XCG-11K					120	75±1.5			8																																																																																			
FR-XCG-15K	255	225	8	240	130	90±1.5	M6	M6	11																																																																																			
FR-XCG-22K					140	85±1.5			16																																																																																			
FR-XCG-30K	300	270	10	285	155	100±1.5	M8	M10	20																																																																																			
FR-XCG-37K					180	100±1.5			25																																																																																			
FR-XCG-55K	300	270	10	285	190	130±1.5	M8	M10	40																																																																																			
400 V class																																																																																												
<table border="1" data-bbox="790 1149 1476 1442"> <thead> <tr> <th>Model</th> <th>W</th> <th>W1</th> <th>W2</th> <th>H</th> <th>D</th> <th>D1</th> <th>Mounting screw size</th> <th>Terminal screw size</th> <th>Mass (kg)</th> </tr> </thead> <tbody> <tr> <td>FR-XCG-H7.5K</td> <td rowspan="2">220</td> <td rowspan="2">200</td> <td rowspan="2">6</td> <td rowspan="2">185</td> <td>115</td> <td>60±1.5</td> <td rowspan="2">M5</td> <td rowspan="2">M5</td> <td>5</td> </tr> <tr> <td>FR-XCG-H11K</td> <td>120</td> <td>75±1.5</td> <td>8</td> </tr> <tr> <td>FR-XCG-H15K</td> <td rowspan="2">255</td> <td rowspan="2">225</td> <td rowspan="2">8</td> <td rowspan="2">240</td> <td>130</td> <td>90±1.5</td> <td rowspan="2">M6</td> <td rowspan="2">M6</td> <td>11</td> </tr> <tr> <td>FR-XCG-H22K</td> <td>140</td> <td>85±1.5</td> <td>16</td> </tr> <tr> <td>FR-XCG-H30K</td> <td rowspan="2">300</td> <td rowspan="2">270</td> <td rowspan="2">10</td> <td rowspan="2">285</td> <td>140</td> <td>100±1.5</td> <td rowspan="2">M8</td> <td rowspan="2">M8</td> <td>20</td> </tr> <tr> <td>FR-XCG-H37K</td> <td>180</td> <td>100±1.5</td> <td>25</td> </tr> <tr> <td>FR-XCG-H55K</td> <td>300</td> <td>270</td> <td>10</td> <td>285</td> <td>190</td> <td>130±1.5</td> <td>M8</td> <td>M8</td> <td>40</td> </tr> <tr> <td>FR-XCG-H75K</td> <td>300</td> <td>270</td> <td>10</td> <td>335</td> <td>200</td> <td>140±2</td> <td>M8</td> <td>M8</td> <td>50</td> </tr> <tr> <td>FR-XCG-H90K</td> <td>300</td> <td>270</td> <td>10</td> <td>360</td> <td>210</td> <td>150±2</td> <td>M8</td> <td>M8</td> <td>60</td> </tr> </tbody> </table>											Model	W	W1	W2	H	D	D1	Mounting screw size	Terminal screw size	Mass (kg)	FR-XCG-H7.5K	220	200	6	185	115	60±1.5	M5	M5	5	FR-XCG-H11K	120	75±1.5	8	FR-XCG-H15K	255	225	8	240	130	90±1.5	M6	M6	11	FR-XCG-H22K	140	85±1.5	16	FR-XCG-H30K	300	270	10	285	140	100±1.5	M8	M8	20	FR-XCG-H37K	180	100±1.5	25	FR-XCG-H55K	300	270	10	285	190	130±1.5	M8	M8	40	FR-XCG-H75K	300	270	10	335	200	140±2	M8	M8	50	FR-XCG-H90K	300	270	10	360	210	150±2	M8	M8	60
Model	W	W1	W2	H	D	D1	Mounting screw size	Terminal screw size	Mass (kg)																																																																																			
FR-XCG-H7.5K	220	200	6	185	115	60±1.5	M5	M5	5																																																																																			
FR-XCG-H11K					120	75±1.5			8																																																																																			
FR-XCG-H15K	255	225	8	240	130	90±1.5	M6	M6	11																																																																																			
FR-XCG-H22K					140	85±1.5			16																																																																																			
FR-XCG-H30K	300	270	10	285	140	100±1.5	M8	M8	20																																																																																			
FR-XCG-H37K					180	100±1.5			25																																																																																			
FR-XCG-H55K	300	270	10	285	190	130±1.5	M8	M8	40																																																																																			
FR-XCG-H75K	300	270	10	335	200	140±2	M8	M8	50																																																																																			
FR-XCG-H90K	300	270	10	360	210	150±2	M8	M8	60																																																																																			

Name (model)

Specification and structure

<<Dedicated box-type reactor FR-XCB>>
FR-XCB-(H)55K or less

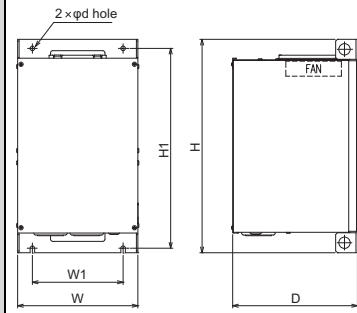

200 V class

Model	W	W1	H	H1	D	d	Screw size	Mass (kg)
FR-XCB-18.5K	265	200	470	440	275	10	M8	26.0
FR-XCB-22K								56.9
FR-XCB-37K	350	270	600	575	330	12	M10	68.5
FR-XCB-55K								

400 V class

Model	W	W1	H	H1	D	d	Screw size	Mass (kg)
FR-XCB-H18.5K	265	200	470	440	275	10	M8	26.9
FR-XCB-H22K								63.0
FR-XCB-H37K	350	270	600	575	330	12	M10	73.0
FR-XCB-H55K								
FR-XCB-H75K	240	80	915	885	410	12	M10	120.0

FR-XCB-H75K

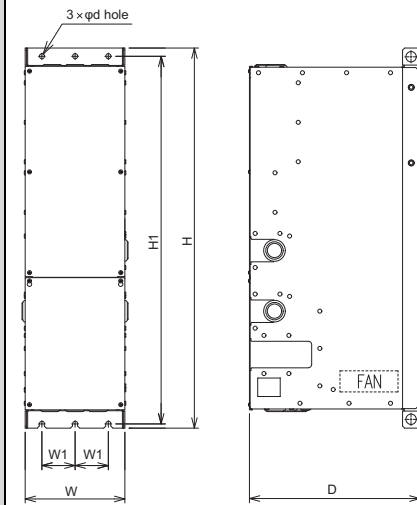

Multifunction regeneration converter
FR-XC
Dedicated stand-alone reactor
FR-XCL/FR-XCG
Dedicated box-type reactor
FR-XCB



<<Dedicated contactor box FR-MCB>>

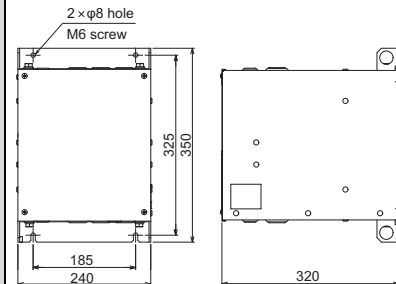

Model	Mass(kg)
FR-MCB-H150	17.0

<<Converter installation enclosure attachment FR-XCCP>>

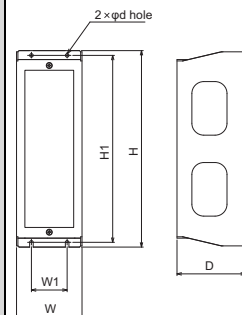

Model	W	W1	H	H1	D	d	Screw size
FR-XCCP01	110	60	330	314	115	6	M5
FR-XCCP02	130	90			120		
FR-XCCP03	160	120	410	396	116	7	M6

Name (model)	Specification and structure																																																																																																																																																																																																																																																				
<p data-bbox="183 739 343 795">High power factor converter FR-HC2</p> 	<p data-bbox="379 219 1495 257">Substantially suppresses power harmonics to obtain the equivalent capacity conversion coefficient K5 = 0 specified in "the Harmonic Suppression Guidelines for Consumers Who Receive High Voltage or Special High Voltage" in Japan.</p> <p data-bbox="379 257 1495 291">The power regeneration function comes standard.</p> <p data-bbox="379 291 1495 324">The common converter driving with several inverters is possible.</p> <ul data-bbox="379 324 1495 358" style="list-style-type: none"> • Selection method <p data-bbox="379 358 1495 392">Select the model according to capacity of the inverter or the applicable motor, whichever larger.</p> <ul data-bbox="379 392 1495 425" style="list-style-type: none"> • Specifications 																																																																																																																																																																																																																																																				
	<table border="1"> <tr> <th>Model: FR-HC2-□ *2</th> <th colspan="5">200 V</th> <th colspan="10">400 V</th> </tr> <tr> <td></td> <th>7.5K</th> <th>15K</th> <th>30K</th> <th>55K</th> <th>75K</th> <th>H7.5K</th> <th>H15K</th> <th>H30K</th> <th>H55K</th> <th>H75K</th> <th>H110K</th> <th>H160K</th> <th>H220K</th> <th>H280K</th> <th>H400K</th> <th>H560K</th> </tr> </table>	Model: FR-HC2-□ *2	200 V					400 V											7.5K	15K	30K	55K	75K	H7.5K	H15K	H30K	H55K	H75K	H110K	H160K	H220K	H280K	H400K	H560K	3.7K to 7.5K	7.5K to 15K	15K to 30K	30K to 55K	37K to 75K	3.7K to 7.5K	7.5K to 15K	15K to 30K	30K to 55K	37K to 75K	55K to 110K	90K to 160K	110K to 220K	160K to 280K	200K to 400K	280K to 560K																																																																																																																																																																																																			
	Model: FR-HC2-□ *2	200 V					400 V																																																																																																																																																																																																																																														
		7.5K	15K	30K	55K	75K	H7.5K	H15K	H30K	H55K	H75K	H110K	H160K	H220K	H280K	H400K	H560K																																																																																																																																																																																																																																				
	<table border="1"> <tr> <th>Rated input voltage/frequency</th> <td colspan="5">Three-phase 200 V to 220 V 50 Hz 200 V to 230 V 60 Hz</td> <td colspan="10">Three-phase 380 V to 460 V 50/60 Hz</td> </tr> </table>	Rated input voltage/frequency	Three-phase 200 V to 220 V 50 Hz 200 V to 230 V 60 Hz					Three-phase 380 V to 460 V 50/60 Hz																																																																																																																																																																																																																																													
	Rated input voltage/frequency	Three-phase 200 V to 220 V 50 Hz 200 V to 230 V 60 Hz					Three-phase 380 V to 460 V 50/60 Hz																																																																																																																																																																																																																																														
	<table border="1"> <tr> <th>Rated input current (A)</th> <td>33</td> <td>61</td> <td>115</td> <td>215</td> <td>278</td> <td>17</td> <td>31</td> <td>57</td> <td>110</td> <td>139</td> <td>203</td> <td>290</td> <td>397</td> <td>506</td> <td>716</td> <td>993</td> </tr> </table>	Rated input current (A)	33	61	115	215	278	17	31	57	110	139	203	290	397	506	716	993																																																																																																																																																																																																																																			
	Rated input current (A)	33	61	115	215	278	17	31	57	110	139	203	290	397	506	716	993																																																																																																																																																																																																																																				
	<p data-bbox="379 616 1495 649">*1 The total capacity of the connected inverters.</p> <p data-bbox="379 649 1495 672">*2 If a high power factor converter (FR-HC2) is purchased, it comes with reactor 1 (FR-HCL21), reactor 2 (FR-HCL22), and an outside box (FR-HCB2). Do not connect the DC reactor to the inverter when using a high power factor converter.</p> <p data-bbox="379 672 1495 694">(If an H280K or higher is purchased, it comes with FR-HCL21, FR-HCL22, FR-HCC2, FR-HCR2, and FR-HCM2.)</p>																																																																																																																																																																																																																																																				
	<p data-bbox="379 694 1495 750">• Outline dimension (Unit: mm)</p>																																																																																																																																																																																																																																																				
<table border="1"> <tr> <th rowspan="2">Voltage</th> <th rowspan="2">Capacity</th> <th colspan="3">High power factor converter FR-HC2</th> <th colspan="3">Reactor 1 FR-HCL21 *1</th> <th colspan="3">Reactor 2 FR-HCL22 *1</th> <th colspan="3">Outside box FR-HCB2 *2</th> </tr> <tr> <th>W</th> <th>H</th> <th>D</th> <th>W</th> <th>H</th> <th>D</th> <th>W</th> <th>H</th> <th>D</th> <th>W</th> <th>H</th> <th>D</th> </tr> </table>	Voltage	Capacity	High power factor converter FR-HC2			Reactor 1 FR-HCL21 *1			Reactor 2 FR-HCL22 *1			Outside box FR-HCB2 *2			W	H	D	W	H	D	W	H	D	W	H	D	<table border="1"> <tr> <td rowspan="5">200 V</td> <td>7.5K</td> <td>220</td> <td>260</td> <td>170</td> <td>132</td> <td>150</td> <td>100</td> <td>237.5</td> <td>230</td> <td>140</td> <td rowspan="2">190</td> <td rowspan="2">320</td> <td rowspan="2">165</td> </tr> <tr> <td>15K</td> <td>250</td> <td>400</td> <td>190</td> <td>162</td> <td>172</td> <td>126</td> <td>257.5</td> <td>260</td> <td>165</td> </tr> <tr> <td>30K</td> <td>325</td> <td>550</td> <td>195</td> <td>195</td> <td>210</td> <td>150</td> <td>342.5</td> <td>305</td> <td>180</td> <td>270</td> <td>450</td> <td>203</td> </tr> <tr> <td>55K</td> <td>370</td> <td>620</td> <td>250</td> <td>210</td> <td>180</td> <td>200.5</td> <td>432.5</td> <td>380</td> <td>280</td> <td>400</td> <td>450</td> <td>250</td> </tr> <tr> <td>75K</td> <td>465</td> <td>620</td> <td>300</td> <td>240</td> <td>215</td> <td>215.5</td> <td>474</td> <td>460</td> <td>280</td> <td>400</td> <td>450</td> <td>250</td> </tr> <tr> <td rowspan="9">400 V</td> <td>H7.5K</td> <td>220</td> <td>300</td> <td>190</td> <td>132</td> <td>140</td> <td>100</td> <td>237.5</td> <td>220</td> <td>140</td> <td rowspan="2">190</td> <td rowspan="2">320</td> <td rowspan="2">165</td> </tr> <tr> <td>H15K</td> <td>220</td> <td>300</td> <td>190</td> <td>162</td> <td>170</td> <td>126</td> <td>257.5</td> <td>260</td> <td>165</td> </tr> <tr> <td>H30K</td> <td>325</td> <td>550</td> <td>195</td> <td>182</td> <td>195</td> <td>101</td> <td>342.5</td> <td>300</td> <td>180</td> <td>270</td> <td>450</td> <td>203</td> </tr> <tr> <td>H55K</td> <td>370</td> <td>670</td> <td>250</td> <td>282.5</td> <td>245</td> <td>165</td> <td>392.5</td> <td>365</td> <td>200</td> <td>270</td> <td>450</td> <td>203</td> </tr> <tr> <td>H75K</td> <td>325</td> <td>620</td> <td>250</td> <td>210</td> <td>175</td> <td>210.5</td> <td>430</td> <td>395</td> <td>280</td> <td>300</td> <td>350</td> <td>250</td> </tr> <tr> <td>H110K</td> <td>465</td> <td>620</td> <td>300</td> <td>240</td> <td>230</td> <td>220</td> <td>500</td> <td>440</td> <td>370</td> <td>350</td> <td>450</td> <td>380</td> </tr> <tr> <td>H160K</td> <td>498</td> <td>1010</td> <td>380</td> <td>280</td> <td>295</td> <td>274.5</td> <td>560</td> <td>520</td> <td>430</td> <td>400</td> <td>450</td> <td>440</td> </tr> <tr> <td>H220K</td> <td>498</td> <td>1010</td> <td>380</td> <td>330</td> <td>335</td> <td>289.5</td> <td>620</td> <td>620</td> <td>480</td> <td>-</td> <td>-</td> <td>-</td> </tr> <tr> <td>H280K</td> <td>680</td> <td>1010</td> <td>380</td> <td>330</td> <td>335</td> <td>321</td> <td>690</td> <td>700</td> <td>560</td> <td>-</td> <td>-</td> <td>-</td> </tr> <tr> <td>H400K</td> <td>790</td> <td>1330</td> <td>440</td> <td>402</td> <td>460</td> <td>550</td> <td>632</td> <td>675</td> <td>705</td> <td>-</td> <td>-</td> <td>-</td> </tr> <tr> <td>H560K</td> <td>790</td> <td>1330</td> <td>440</td> <td>452</td> <td>545</td> <td>645</td> <td>632</td> <td>720</td> <td>745</td> <td>-</td> <td>-</td> <td>-</td> </tr> </table>															200 V	7.5K	220	260	170	132	150	100	237.5	230	140	190	320	165	15K	250	400	190	162	172	126	257.5	260	165	30K	325	550	195	195	210	150	342.5	305	180	270	450	203	55K	370	620	250	210	180	200.5	432.5	380	280	400	450	250	75K	465	620	300	240	215	215.5	474	460	280	400	450	250	400 V	H7.5K	220	300	190	132	140	100	237.5	220	140	190	320	165	H15K	220	300	190	162	170	126	257.5	260	165	H30K	325	550	195	182	195	101	342.5	300	180	270	450	203	H55K	370	670	250	282.5	245	165	392.5	365	200	270	450	203	H75K	325	620	250	210	175	210.5	430	395	280	300	350	250	H110K	465	620	300	240	230	220	500	440	370	350	450	380	H160K	498	1010	380	280	295	274.5	560	520	430	400	450	440	H220K	498	1010	380	330	335	289.5	620	620	480	-	-	-	H280K	680	1010	380	330	335	321	690	700	560	-	-	-	H400K	790	1330	440	402	460	550	632	675	705	-	-	-	H560K	790	1330	440	452	545	645	632	720	745	-	-	-
Voltage			Capacity	High power factor converter FR-HC2			Reactor 1 FR-HCL21 *1			Reactor 2 FR-HCL22 *1			Outside box FR-HCB2 *2																																																																																																																																																																																																																																								
	W	H		D	W	H	D	W	H	D	W	H	D																																																																																																																																																																																																																																								
200 V	7.5K	220	260	170	132	150	100	237.5	230	140	190	320	165																																																																																																																																																																																																																																								
	15K	250	400	190	162	172	126	257.5	260	165																																																																																																																																																																																																																																											
	30K	325	550	195	195	210	150	342.5	305	180	270	450	203																																																																																																																																																																																																																																								
	55K	370	620	250	210	180	200.5	432.5	380	280	400	450	250																																																																																																																																																																																																																																								
	75K	465	620	300	240	215	215.5	474	460	280	400	450	250																																																																																																																																																																																																																																								
400 V	H7.5K	220	300	190	132	140	100	237.5	220	140	190	320	165																																																																																																																																																																																																																																								
	H15K	220	300	190	162	170	126	257.5	260	165																																																																																																																																																																																																																																											
	H30K	325	550	195	182	195	101	342.5	300	180	270	450	203																																																																																																																																																																																																																																								
	H55K	370	670	250	282.5	245	165	392.5	365	200	270	450	203																																																																																																																																																																																																																																								
	H75K	325	620	250	210	175	210.5	430	395	280	300	350	250																																																																																																																																																																																																																																								
	H110K	465	620	300	240	230	220	500	440	370	350	450	380																																																																																																																																																																																																																																								
	H160K	498	1010	380	280	295	274.5	560	520	430	400	450	440																																																																																																																																																																																																																																								
	H220K	498	1010	380	330	335	289.5	620	620	480	-	-	-																																																																																																																																																																																																																																								
	H280K	680	1010	380	330	335	321	690	700	560	-	-	-																																																																																																																																																																																																																																								
H400K	790	1330	440	402	460	550	632	675	705	-	-	-																																																																																																																																																																																																																																									
H560K	790	1330	440	452	545	645	632	720	745	-	-	-																																																																																																																																																																																																																																									
<div style="display: flex; justify-content: space-around;"> <div data-bbox="526 1321 742 1478"> <p>High power factor converter</p> </div> <div data-bbox="821 1321 1029 1478"> <p>Reactor 1, Reactor 2</p> </div> <div data-bbox="1125 1321 1332 1478"> <p>Outside box</p> </div> </div>																																																																																																																																																																																																																																																					
<p data-bbox="379 1489 1495 1523">*1 Install reactors (FR-HCL21 and 22) on a horizontal surface.</p> <p data-bbox="379 1523 1495 1538">*2 The H280K or higher are not equipped with FR-HCB2. A filter capacitor and inrush current limit resistors are provided instead.</p>																																																																																																																																																																																																																																																					

Name (model)	Specification and structure																																																																																																																								
Surge voltage suppression filter FR-ASF	<p>A surge voltage suppression filter limits surge voltage applied to motor terminals when driving the 400 V class motor by the inverter.</p> <ul style="list-style-type: none"> • Selection method • Select the model according to the applied motor capacity. • Specifications 																																																																																																																								
	<table border="1" style="width: 100%; border-collapse: collapse;"> <thead> <tr> <th style="background-color: #cccccc;">Model: FR-ASF-[]</th> <th colspan="7" style="background-color: #cccccc;">400 V</th> </tr> <tr> <th style="background-color: #cccccc;"></th> <th style="background-color: #cccccc;">H1.5K</th> <th style="background-color: #cccccc;">H3.7K</th> <th style="background-color: #cccccc;">H7.5K</th> <th style="background-color: #cccccc;">H15K</th> <th style="background-color: #cccccc;">H22K</th> <th style="background-color: #cccccc;">H37K</th> <th style="background-color: #cccccc;">H55K</th> </tr> </thead> <tbody> <tr> <td style="background-color: #cccccc;">Applicable motor capacity (kW)</td> <td>0.4 to 1.5</td> <td>2.2 to 3.7</td> <td>5.5 to 7.5</td> <td>11 to 15</td> <td>18.5 to 22</td> <td>30 to 37</td> <td>45 to 55</td> </tr> <tr> <td style="background-color: #cccccc;">Rated input current (A)</td> <td>4.0</td> <td>9.0</td> <td></td> <td>31.0</td> <td>43.0</td> <td>71.0</td> <td>110.0</td> </tr> <tr> <td style="background-color: #cccccc;">Overload current rating *1</td> <td colspan="7">150% 60 s, 200% 0.5 s</td> </tr> <tr> <td style="background-color: #cccccc;">Rated input AC voltage *1</td> <td colspan="7">Three-phase 380 V to 460 V 50 Hz/60 Hz</td> </tr> <tr> <td style="background-color: #cccccc;">Maximum AC voltage fluctuation *1</td> <td colspan="7">Three-phase 506 V 50 Hz/60 Hz</td> </tr> <tr> <td style="background-color: #cccccc;">Maximum frequency *1</td> <td colspan="7">400 Hz</td> </tr> <tr> <td style="background-color: #cccccc;">PWM frequency permissible range</td> <td colspan="7">0.5 kHz to 14.5 kHz</td> </tr> <tr> <td style="background-color: #cccccc;">Maximum wiring length between the filter-motor</td> <td colspan="7">300 m</td> </tr> <tr> <td style="background-color: #cccccc;">Approx. mass (kg)</td> <td>8.0</td> <td>11.0</td> <td>20.0</td> <td>28.0</td> <td>38.0</td> <td>59.0</td> <td>78.0</td> </tr> <tr> <td style="background-color: #cccccc;">Environment</td> <td colspan="7">Surrounding air temperature -10°C to +50°C (non-freezing)</td> </tr> <tr> <td style="background-color: #cccccc;"></td> <td colspan="7">Surrounding air humidity 90% RH or less (non-condensing)</td> </tr> <tr> <td style="background-color: #cccccc;"></td> <td colspan="7">Atmosphere Indoors (without corrosive gas, flammable gas, oil mist, dust and dirt, etc.)</td> </tr> <tr> <td style="background-color: #cccccc;"></td> <td colspan="7">Altitude/vibration Maximum 1000 m, 5.9 m/s² or less at 10 to 55 Hz (directions of X, Y, Z axes)</td> </tr> </tbody> </table>	Model: FR-ASF-[]	400 V								H1.5K	H3.7K	H7.5K	H15K	H22K	H37K	H55K	Applicable motor capacity (kW)	0.4 to 1.5	2.2 to 3.7	5.5 to 7.5	11 to 15	18.5 to 22	30 to 37	45 to 55	Rated input current (A)	4.0	9.0		31.0	43.0	71.0	110.0	Overload current rating *1	150% 60 s, 200% 0.5 s							Rated input AC voltage *1	Three-phase 380 V to 460 V 50 Hz/60 Hz							Maximum AC voltage fluctuation *1	Three-phase 506 V 50 Hz/60 Hz							Maximum frequency *1	400 Hz							PWM frequency permissible range	0.5 kHz to 14.5 kHz							Maximum wiring length between the filter-motor	300 m							Approx. mass (kg)	8.0	11.0	20.0	28.0	38.0	59.0	78.0	Environment	Surrounding air temperature -10°C to +50°C (non-freezing)								Surrounding air humidity 90% RH or less (non-condensing)								Atmosphere Indoors (without corrosive gas, flammable gas, oil mist, dust and dirt, etc.)								Altitude/vibration Maximum 1000 m, 5.9 m/s ² or less at 10 to 55 Hz (directions of X, Y, Z axes)						
	Model: FR-ASF-[]	400 V																																																																																																																							
		H1.5K	H3.7K	H7.5K	H15K	H22K	H37K	H55K																																																																																																																	
	Applicable motor capacity (kW)	0.4 to 1.5	2.2 to 3.7	5.5 to 7.5	11 to 15	18.5 to 22	30 to 37	45 to 55																																																																																																																	
	Rated input current (A)	4.0	9.0		31.0	43.0	71.0	110.0																																																																																																																	
	Overload current rating *1	150% 60 s, 200% 0.5 s																																																																																																																							
	Rated input AC voltage *1	Three-phase 380 V to 460 V 50 Hz/60 Hz																																																																																																																							
	Maximum AC voltage fluctuation *1	Three-phase 506 V 50 Hz/60 Hz																																																																																																																							
	Maximum frequency *1	400 Hz																																																																																																																							
	PWM frequency permissible range	0.5 kHz to 14.5 kHz																																																																																																																							
	Maximum wiring length between the filter-motor	300 m																																																																																																																							
	Approx. mass (kg)	8.0	11.0	20.0	28.0	38.0	59.0	78.0																																																																																																																	
	Environment	Surrounding air temperature -10°C to +50°C (non-freezing)																																																																																																																							
		Surrounding air humidity 90% RH or less (non-condensing)																																																																																																																							
	Atmosphere Indoors (without corrosive gas, flammable gas, oil mist, dust and dirt, etc.)																																																																																																																								
	Altitude/vibration Maximum 1000 m, 5.9 m/s ² or less at 10 to 55 Hz (directions of X, Y, Z axes)																																																																																																																								
	<p>*1 Determined by the specification of the connected inverter (400 V class).</p>																																																																																																																								
	<ul style="list-style-type: none"> • Connection diagram 																																																																																																																								
	<ul style="list-style-type: none"> • Outline dimension (Unit: mm) 																																																																																																																								
	<table border="1" style="width: 100%; border-collapse: collapse;"> <thead> <tr> <th style="background-color: #cccccc;">Model</th> <th style="background-color: #cccccc;">W *1</th> <th style="background-color: #cccccc;">H *1</th> <th style="background-color: #cccccc;">D *1</th> </tr> </thead> <tbody> <tr> <td style="background-color: #cccccc;">FR-ASF-H1.5K</td> <td>221</td> <td>193</td> <td>160</td> </tr> <tr> <td style="background-color: #cccccc;">FR-ASF-H3.7K</td> <td>221</td> <td>200</td> <td>180</td> </tr> <tr> <td style="background-color: #cccccc;">FR-ASF-H7.5K</td> <td>281</td> <td>250</td> <td>215</td> </tr> <tr> <td style="background-color: #cccccc;">FR-ASF-H15K *2</td> <td>336</td> <td>265</td> <td>290</td> </tr> <tr> <td style="background-color: #cccccc;">FR-ASF-H22K *2</td> <td>336</td> <td>345</td> <td>354</td> </tr> <tr> <td style="background-color: #cccccc;">FR-ASF-H37K *2</td> <td>376</td> <td>464</td> <td>429</td> </tr> <tr> <td style="background-color: #cccccc;">FR-ASF-H55K *2</td> <td>396</td> <td>464</td> <td>594</td> </tr> </tbody> </table>	Model	W *1	H *1	D *1	FR-ASF-H1.5K	221	193	160	FR-ASF-H3.7K	221	200	180	FR-ASF-H7.5K	281	250	215	FR-ASF-H15K *2	336	265	290	FR-ASF-H22K *2	336	345	354	FR-ASF-H37K *2	376	464	429	FR-ASF-H55K *2	396	464	594																																																																																								
Model	W *1	H *1	D *1																																																																																																																						
FR-ASF-H1.5K	221	193	160																																																																																																																						
FR-ASF-H3.7K	221	200	180																																																																																																																						
FR-ASF-H7.5K	281	250	215																																																																																																																						
FR-ASF-H15K *2	336	265	290																																																																																																																						
FR-ASF-H22K *2	336	345	354																																																																																																																						
FR-ASF-H37K *2	376	464	429																																																																																																																						
FR-ASF-H55K *2	396	464	594																																																																																																																						
	<p>*1 This indicates the maximum dimension. *2 The H15K or higher has a different shape.</p>																																																																																																																								

Name (model)	Specification and structure																																																																																																																																																				
Surge voltage suppression filter FR-BMF	Limits surge voltage applied to motor terminals when driving a 400 V class motor with an inverter. This filter is compatible with the 5.5 to 37 kW motors.																																																																																																																																																				
	• Selection method																																																																																																																																																				
	Select the model according to the applied motor capacity.																																																																																																																																																				
	• Specifications																																																																																																																																																				
	<table border="1" style="width: 100%; border-collapse: collapse;"> <thead> <tr> <th style="text-align: left;">Model: FR-BMF-H□K</th> <th colspan="2">7.5</th> <th colspan="2">15</th> <th colspan="2">22</th> <th colspan="2">37</th> </tr> </thead> <tbody> <tr> <td>Applicable motor capacity (kW) *1</td> <td>5.5</td> <td>7.5</td> <td>11</td> <td>15</td> <td>18.5</td> <td>22</td> <td>30</td> <td>37</td> </tr> <tr> <td>Rated current (A)</td> <td colspan="2">17</td> <td colspan="2">31</td> <td colspan="2">43</td> <td colspan="2">71</td> </tr> <tr> <td>Overload current rating *2</td> <td colspan="8">150% 60 s, 200% 0.5 s (inverse-time characteristics)</td> </tr> <tr> <td>Rated AC input voltage *2</td> <td colspan="8">Three-phase 380 to 480 V</td> </tr> <tr> <td>Permissible AC voltage fluctuation *2</td> <td colspan="8">323 to 528 V</td> </tr> <tr> <td>Maximum frequency *2</td> <td colspan="8">120 Hz</td> </tr> <tr> <td>PWM carrier frequency</td> <td colspan="8">2 kHz or lower *3</td> </tr> <tr> <td>Protective structure (JEM 1030)</td> <td colspan="8">Open type (IP00)</td> </tr> <tr> <td>Cooling system</td> <td colspan="8">Self-cooling</td> </tr> <tr> <td>Maximum wiring length</td> <td colspan="8">100m or lower</td> </tr> <tr> <td>Approx. mass (kg)</td> <td colspan="2">5.5</td> <td colspan="2">9.5</td> <td colspan="2">11.5</td> <td colspan="2">19</td> </tr> <tr> <td rowspan="4" style="writing-mode: vertical-rl; transform: rotate(180deg);">Environment</td> <td>Surrounding air temperature</td> <td colspan="7">-10°C to +50°C (non-freezing)</td> </tr> <tr> <td>Surrounding air humidity</td> <td colspan="7">90% RH or less (non-condensing)</td> </tr> <tr> <td>Atmosphere</td> <td colspan="7">Indoors (without corrosive gas, flammable gas, oil mist, dust and dirt, etc.)</td> </tr> <tr> <td>Altitude/vibration</td> <td colspan="7">Maximum 1000 m, 5.9 m/s² or less *4 at 10 to 55 Hz (directions of X, Y, Z axes)</td> </tr> </tbody> </table>								Model: FR-BMF-H□K	7.5		15		22		37		Applicable motor capacity (kW) *1	5.5	7.5	11	15	18.5	22	30	37	Rated current (A)	17		31		43		71		Overload current rating *2	150% 60 s, 200% 0.5 s (inverse-time characteristics)								Rated AC input voltage *2	Three-phase 380 to 480 V								Permissible AC voltage fluctuation *2	323 to 528 V								Maximum frequency *2	120 Hz								PWM carrier frequency	2 kHz or lower *3								Protective structure (JEM 1030)	Open type (IP00)								Cooling system	Self-cooling								Maximum wiring length	100m or lower								Approx. mass (kg)	5.5		9.5		11.5		19		Environment	Surrounding air temperature	-10°C to +50°C (non-freezing)							Surrounding air humidity	90% RH or less (non-condensing)							Atmosphere	Indoors (without corrosive gas, flammable gas, oil mist, dust and dirt, etc.)							Altitude/vibration	Maximum 1000 m, 5.9 m/s ² or less *4 at 10 to 55 Hz (directions of X, Y, Z axes)						
	Model: FR-BMF-H□K	7.5		15		22		37																																																																																																																																													
	Applicable motor capacity (kW) *1	5.5	7.5	11	15	18.5	22	30	37																																																																																																																																												
	Rated current (A)	17		31		43		71																																																																																																																																													
	Overload current rating *2	150% 60 s, 200% 0.5 s (inverse-time characteristics)																																																																																																																																																			
	Rated AC input voltage *2	Three-phase 380 to 480 V																																																																																																																																																			
	Permissible AC voltage fluctuation *2	323 to 528 V																																																																																																																																																			
	Maximum frequency *2	120 Hz																																																																																																																																																			
	PWM carrier frequency	2 kHz or lower *3																																																																																																																																																			
	Protective structure (JEM 1030)	Open type (IP00)																																																																																																																																																			
	Cooling system	Self-cooling																																																																																																																																																			
	Maximum wiring length	100m or lower																																																																																																																																																			
	Approx. mass (kg)	5.5		9.5		11.5		19																																																																																																																																													
	Environment	Surrounding air temperature	-10°C to +50°C (non-freezing)																																																																																																																																																		
		Surrounding air humidity	90% RH or less (non-condensing)																																																																																																																																																		
		Atmosphere	Indoors (without corrosive gas, flammable gas, oil mist, dust and dirt, etc.)																																																																																																																																																		
		Altitude/vibration	Maximum 1000 m, 5.9 m/s ² or less *4 at 10 to 55 Hz (directions of X, Y, Z axes)																																																																																																																																																		
	*1 Indicates the maximum capacity applicable with the Mitsubishi Electric standard 4-pole motor. (PM motors are not applicable.)																																																																																																																																																				
*2 Determined by the specification of the connected inverter (400 V class).																																																																																																																																																					
*3 Set the Pr.72 PWM frequency selection to 2 kHz or less.																																																																																																																																																					
*4 When an inverter has a filter mounted on its back, do not use such an inverter on a moving object or in a place that vibrates (exceeding 1.96 m/s ²).																																																																																																																																																					
• Connection diagram																																																																																																																																																					
<p style="text-align: center;">* Install a step-down transformer.</p>																																																																																																																																																					
• Outline dimension (Unit: mm)																																																																																																																																																					
<p>FR-BMF-H7.5K</p>		<p>FR-BMF-H15K, H22K</p>		<p>FR-BMF-H37K</p>																																																																																																																																																	

Low-Voltage Switchgear/Cables

● Mitsubishi Electric Molded Case Circuit Breakers and Earth Leakage Circuit Breakers WS-V Series

Our main series of products in the industry's smallest class with high breaking capability enabled by a new breaking technology.

The new WS-V series breaker has enhanced usability by further standardizing internal parts, meets international standards, and addresses environmental and energy-saving issues.

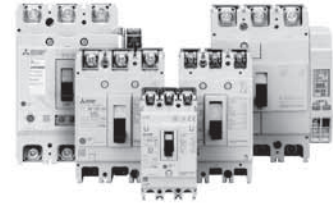

◆ Features

◆ A 54-mm-wide body, which belongs to the smallest class in the industry

The compact body allows for downsizing of the equipment and enclosure.

The breakers have been downsized to 54 mm wide and 52 mm depth (decreased by 16 mm compared with S-class general-purpose products).

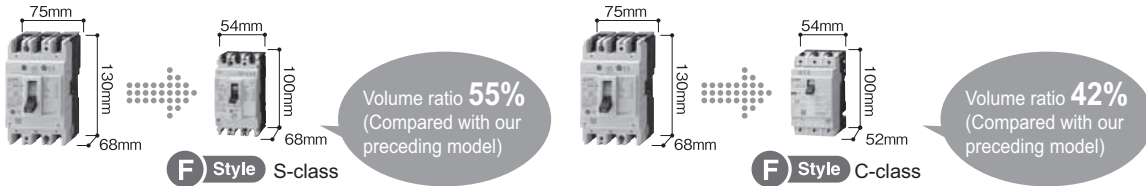

When multiple units are used, the width becomes significantly smaller.

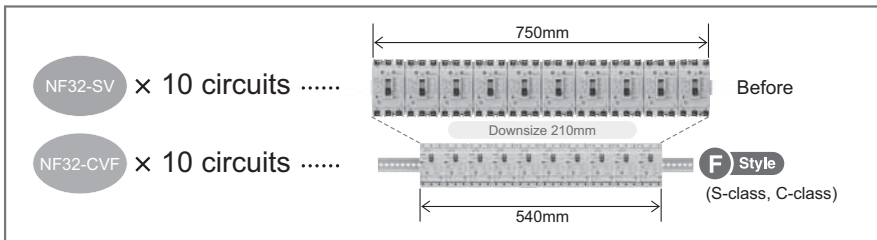

◆ Conforms to various global standards

- New JIS standard: JIS C 8201-2-1 (NF) Annex 1 and Annex 2
- Electrical Appliances and Materials Safety Act (PSE)
- IEC standard: IEC 60947-2
- EN (Europe): EN 60947-2, CE marking (TÜV certification, self declaration)
- GB standard (China): GB/T 14048.2 CCC certification
- Safety certification (Korea): KC marking



◆ Three-phase power supply supported by CE/CCC marked earth leakage circuit breakers

GB/T 14048.2-2008 was established in China, requiring the earth leakage circuit breaker to fulfill its function even if a phase is lost as is the case with the EN standard in Europe. CE/CCC marked earth leakage circuit breakers of the WS-V series support three phase power supply. Compliance with the revised standard is certified.

◆ Lineup of UL 489 listed circuit breakers with 54 mm width "Small Fit" **F Style**

The compact breakers contribute to a size reduction of machines, and IEC 35 mm rail mounting is standard.

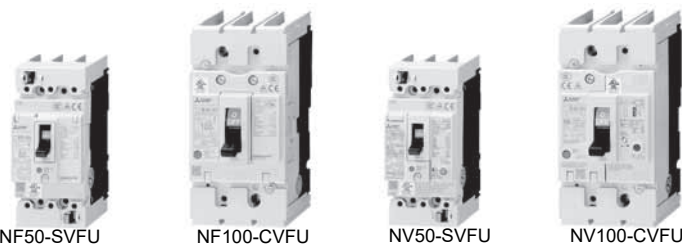

For security and standard compliance of machines, F-type and V-type operating handles are available for breakers with 54 mm width.

◆ Lineup of UL 489 listed circuit breakers for 480 V AC "High Performance"

The breaking capacity has been improved to satisfy the request for SCCR upgrading.

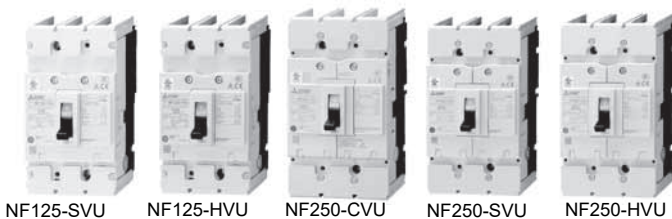

Breaking capacity of UL 489 listed circuit breakers for 480 V AC (UL 489) (Example of 240 V AC)

NF125-SVU/NV125-SVU	50 kA
NF125-HVU/NV125-HVU	100 kA
NF250-CVU/NV250-CVU	35 kA
NF250-SVU/NV250-SVU	65 kA
NF250-HVU/NV250-HVU	100 kA

Mitsubishi Electric Magnetic Motor Starters and Magnetic Contactors MS-T Series

Mitsubishi Electric magnetic motor starters have been newly designed and the MS-T series has been released. The MS-T series is smaller than ever, enabling more compact control panel. The MS-T series is suitable for other Mitsubishi Electric FA equipment. In addition, the MS-T conforms to a variety of global standards, supporting the global use.



S-T10

◆ Features

◆ Compact











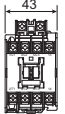
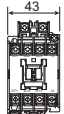

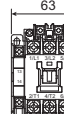
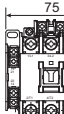
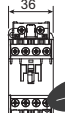
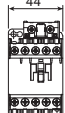
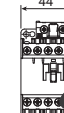
General-purpose magnetic contactor with smallest width*1 in the industry.

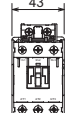
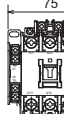
The width of MS-T series is reduced by 32% as compared to the prior MS-N series, enabling a more compact panel.

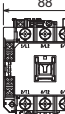
For selection, refer to **page 122**.

*1 Based on Mitsubishi Electric research as of November 2020 in the general-purpose magnetic contactor industry for 10 A-frame class.

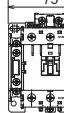
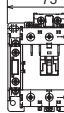
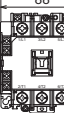
[Unit: mm]

Frame size	11A	13A		20A	25A	32A	
MS-N series	 S-N10	 S-N11 (Auxiliary 1-pole)	 S-N12 (Auxiliary 2-pole)	 S-N20	 S-N25	None	
New MS-T series	 S-T10	 S-T12 (Auxiliary 2-pole)		 S-T20	 S-T25	 S-T32	
Frame size	35A	50A		65A	80A	100A	
MS-N series	 S-N35	 S-N50	 S-N50AE	 S-N65	 S-N65AE	 S-N80	 S-N95
New MS-T series	 S-T35	 S-T50		 S-T65	 S-T80	 S-T100	

◆ Standardization

• Terminal covers are provided as standard to ensure safety inside the enclosure. Users do not have to make arrangements to specify and obtain options separately. Covers are provided also for the auxiliary contact unit. Users can reduce their inventory.

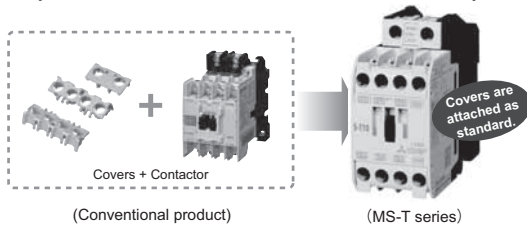

• Widened range of operation coil ratings (AC operated model)
The widened range reduces the number of operation coil rating types from 13 (MS-N series) to 7.
The reduced number of the operation coil types enables more simplified customers' ordering process and the faster delivery.

• Customers can select the operation coil more easily.

(Conventional product)

Coil designation	Rated voltage [V]	
	50 Hz	60 Hz
24 VAC	24	24
48 VAC	48 to 50	48 to 50
100 VAC	100	100 to 110
120 VAC	110 to 120	115 to 120
127 VAC	125 to 127	127
200 VAC	200	200 to 220
220 VAC	208 to 220	220
230 VAC	220 to 240	230 to 240
280 VAC	240 to 280	260 to 280
380 VAC	348 to 380	380
400 VAC	380 to 415	400 to 440
440 VAC	415-440	460 to 480
500 VAC	500	500 to 550

(MS-T series)

Coil designation	Rated voltage [V]
	50 Hz/60 Hz
24 VAC	24
48 VAC	48 to 50
100 VAC	100 to 127
200 VAC	200 to 240
300 VAC	260 to 300
400 VAC	380 to 440
500 VAC	460 to 550

Integrated coil ratings facilitate selection!

*Seven types are available without change for the 50 A frame model or higher.

◆ Global Standard

• Conforms to various global standards
Our magnetic contactors are certified as compliant not only with major international standards such as IEC, JIS, UL, CE, and CCC but also with ship classification standards and country specific standards.
This will help our customers expand their business overseas.

Standard	Applicable Standard				Safety Standard
	International	Japan	Europe	China	U.S.A./ Canada
	IEC*2	JIS	EN EC Directive CE	Certification body TUV Rheinland CCC	GB

*2 Compliant with the requirements for mirror contacts in standards such as IEC 60947-4-1, and TÜV-certified.

● Spring Clamp Terminal Models Available for Mitsubishi Electric Magnetic Contactor and Magnetic Relay

Spring clamp terminal:

Easy-to-connect terminal that ensures connection with the contact pressure of the spring just by pushing wire into the conductive terminal. Solid wires and ferrules can be connected simply by inserting them into the terminals.

Stranded wires can be connected by opening the spring with a tool, inserting wire, and removing the tool.



◆ Features

Key features of the screwless terminals:

- Significant reduction in the time required for wiring
Comparison with the terminal screw model (with round crimp terminal)
Wiring with ferrules: 22% reduction
Wiring with solid or stranded wire: 52% reduction
Reduction in the time required for wiring
Wiring performed by non-experts (with 2-year experience) (The research conducted by Japan Switchboard & control system Industries Association)
- Easy wiring for whoever works on
Push-in connection eliminates the need for the screw-tightening skills.
- Enhanced maintenance efficiency
Screw retightening is not necessary for installation and maintenance of enclosures and machines.
- Reliable wire connection
There is no risk of terminal screw loosening due to vibration or shocks, or long-term service.

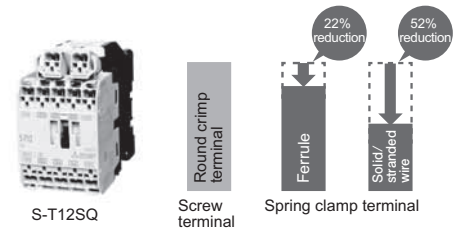

● Motor Circuit Breaker MMP-T Series

Motor circuit protection (against overload / phase loss / short-circuit) is achievable the MMP-T series alone. The wire-saving, space-saving design enables downsizing of the enclosure. The MMP-T series can be used in combination with the MS-T series.



MMP-T32

◆ Features

◆ What is the motor circuit breaker?

The motor circuit breaker, applicable to the motor circuit, has the functions of a circuit breaker and a thermal overload relay in one unit. The motor circuit breaker provides protection against overload, phase loss, and short circuit.

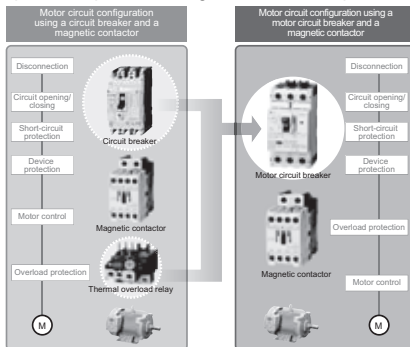

◆ Space-saving design for downsizing of the enclosure

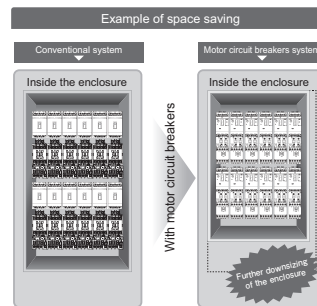

◆ Wire saving

Using a connection conductor unit (option) for connecting a motor circuit breaker and a contactor reduces work hours required for wiring.

A connection conductor unit for the high sensitivity contactor (SD-Q) is also available. (Model: UT-MQ12)

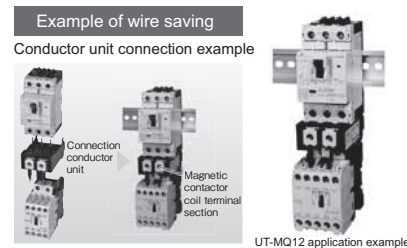

UT-MQ12 application example

● Selecting the rated sensitivity current for the earth leakage circuit breaker

When using an earth leakage circuit breaker with the inverter circuit, select its rated sensitivity current as follows, independently of the PWM carrier frequency.

- Breaker designed for harmonic and surge suppression

Rated sensitivity current

$$I\Delta n \geq 10 \times (I_{g1} + I_{gn} + I_{gi} + I_{g2} + I_{gm})$$

- Standard breaker

Rated sensitivity current

$$I\Delta n \geq 10 \times \{I_{g1} + I_{gn} + I_{gi} + 3 \times (I_{g2} + I_{gm})\}$$

I_{g1} , I_{g2} : Leakage currents in wire path during commercial power supply operation

I_{gn} : Leakage current of inverter input side noise filter

I_{gm} : Leakage current of motor during commercial power supply operation

I_{gi} : Leakage current of inverter unit

Example of leakage current of cable path per 1 km during the commercial power supply operation when the CV cable is routed in metal conduit (200 V 60 Hz)

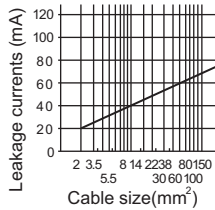

Leakage current example of three-phase induction motor during the commercial power supply operation (200 V 60 Hz)

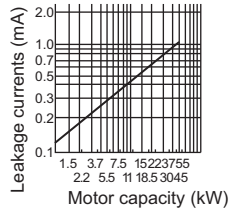

Example of leakage current per 1 km during the commercial power supply operation when the CV cable is routed in metal conduit

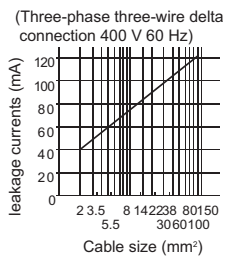

Leakage current example of three-phase induction motor during the commercial power supply operation

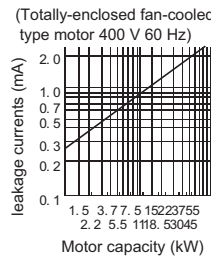

For "Δ" connection, the amount of leakage current is approx. 1/3 of the above value.

<Example>

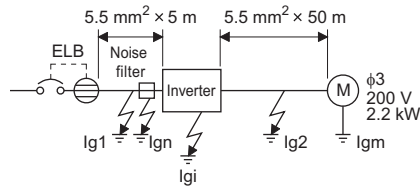

- Install the earth leakage circuit breaker (ELB) on the input side of the inverter.
- In the Δ connection earthed-neutral system, the sensitivity current is blunt against a ground fault in the inverter output side. Earthing (Grounding) must conform to the requirements of national and local safety regulations and electrical codes. (NEC section 250, IEC 61140 class 1 and other applicable standards)

◆ Selection example (in the case of the above figure)

	Breaker designed for harmonic and surge suppression	Standard breaker
Leakage current I_{g1} (mA)	$33 \times \frac{5 \text{ m}}{1000 \text{ m}} = 0.17$	
Leakage current I_{gn} (mA)	0	
Leakage current I_{gi} (mA)	1	
Leakage current I_{g2} (mA)	$33 \times \frac{50 \text{ m}}{1000 \text{ m}} = 1.65$	
Motor leakage current I_{gm} (mA)	0.18	
Total leakage current (mA)	3.00	6.66
Rated sensitivity current (mA) ($\geq I_g \times 10$)	30	100

● Molded case circuit breaker, magnetic contactor, cable gauge

Voltage	Motor output (kW) *1	Applicable inverter model (ND rating)	Molded case circuit breaker (MCCB) *2 or earth leakage circuit breaker (ELB) (NF, NV type)		Input side magnetic contactor *3		Recommended cable gauge (mm ²) *4		
			Power factor improving (AC or DC) reactor connection		Power factor improving (AC or DC) reactor connection		R/L1, S/L2, T/L3		U, V, W
			Without	With	Without	With	Without	With	
Three-phase 200 V	0.1	FR-E820-0008(0.1K)	5A	5A	S-T10	S-T10	2	2	2*5
	0.2	FR-E820-0015(0.2K)	5A	5A	S-T10	S-T10	2	2	2*5
	0.4	FR-E820-0030(0.4K)	5A	5A	S-T10	S-T10	2	2	2*5
	0.75	FR-E820-0050(0.75K)	10A	10A	S-T10	S-T10	2	2	2*5
	1.5	FR-E820-0080(1.5K)	15A	15A	S-T10	S-T10	2	2	2
	2.2	FR-E820-0110(2.2K)	20A	15A	S-T10	S-T10	2	2	2
	3.7	FR-E820-0175(3.7K)	30A	30A	S-T21	S-T10	3.5	3.5	3.5
	5.5	FR-E820-0240(5.5K)	50A	40A	S-T35	S-T21	5.5	5.5	5.5
	7.5	FR-E820-0330(7.5K)	60A	50A	S-T35	S-T35	14	8	8
	11	FR-E820-0470(11K)	75A	75A	S-T35	S-T35	14	14	14
	15	FR-E820-0600(15K)	125A	100A	S-T50	S-T50	22	22	22
	18.5	FR-E820-0760(18.5K)	150A	125A	S-T65	S-T50	38	22	22
22	FR-E820-0900(22K)	175A	150A	S-T100	S-T65	38	38	38	
Three-phase 400 V	0.4	FR-E840-0016(0.4K)	5A	5A	S-T10	S-T10	2	2	2
	0.75	FR-E840-0026(0.75K)	5A	5A	S-T10	S-T10	2	2	2
	1.5	FR-E840-0040(1.5K)	10A	10A	S-T10	S-T10	2	2	2
	2.2	FR-E840-0060(2.2K)	15A	10A	S-T10	S-T10	2	2	2
	3.7	FR-E840-0095(3.7K)	20A	15A	S-T10	S-T10	2	2	2
	5.5	FR-E840-0120(5.5K)	30A	20A	S-T21	S-T12	3.5	2	2
	7.5	FR-E840-0170(7.5K)	30A	30A	S-T21	S-T21	3.5	3.5	3.5
	11	FR-E840-0230(11K)	50A	40A	S-T21	S-T21	5.5	5.5	5.5
	15	FR-E840-0300(15K)	60A	50A	S-T35	S-T21	8	8	8
	18.5	FR-E840-0380(18.5K)	75A	60A	S-T35	S-T35	14	8	8
22	FR-E840-0440(22K)	100A	75A	S-T35	S-T35	14	14	14	
Three-phase 575 V	0.75	FR-E860-0017(0.75K)	5A	5A	3A	3A	2	2	2
	1.5	FR-E860-0027(1.5K)	10A	5A	3A	5A	2	2	2
	2.2	FR-E860-0040(2.2K)	10A	10A	5A	7A	2	2	2
	3.7	FR-E860-0061(3.7K)	15A	10A	7A	10A	2	2	2
	5.5	FR-E860-0090(5.5K)	20A	15A	10A	15A	2	2	2
	7.5	FR-E860-0120(7.5K)	30A	20A	15A	20A	3.5	2	2
Single-phase 200 V	0.1	FR-E820S-0008(0.1K)	5A	5A	S-T10	S-T10	2	2	2*5
	0.2	FR-E820S-0015(0.2K)	5A	5A	S-T10	S-T10	2	2	2*5
	0.4	FR-E820S-0030(0.4K)	10A	10A	S-T10	S-T10	2	2	2*5
	0.75	FR-E820S-0050(0.75K)	15A	10A	S-T10	S-T10	2	2	2
	1.5	FR-E820S-0080(1.5K)	20A	20A	S-T10	S-T10	2	2	2
	2.2	FR-E820S-0110(2.2K)	40A	30A	S-T21	S-T10	3.5	3.5	2
Single-phase 100 V	0.1	FR-E810W-0008(0.1K)	10A	5A	S-T10	S-T10	2	2	2*5
	0.2	FR-E810W-0015(0.2K)	10A	10A	S-T10	S-T10	2	2	2*5
	0.4	FR-E810W-0030(0.4K)	15A	15A	S-T10	S-T10	2	2	2*5
	0.75	FR-E810W-0050(0.75K)	30A	20A	S-T10	S-T10	3.5	3.5	2

*1 Assumes the use of a standard 4-pole motor.

*2 Select an MCCB according to the power supply capacity. Install one MCCB per inverter.

(For the use in the United States or Canada, refer to "Instructions for UL and cUL" in the document enclosed with the product and select appropriate fuses.)

*3 The magnetic contactor is selected based on the AC-1 class. The electrical durability of magnetic contactor is 500,000 times. When the magnetic contactor is used for emergency stops during motor driving, the electrical durability is 25 times.

If using an MC for emergency stop during motor driving or using it on the motor side during commercial power supply operation, select an MC with the class AC-3 rated current for the rated motor current.

*4 Cables

The gauge of the cable with the continuous maximum permissible temperature of 90°C or higher. (LMFC (heat resistant flexible cross-linked polyethylene insulated cable), etc.). It is assumed that the cables will be used in a surrounding air temperatures of 40° C or less and housed in an enclosure.

*5 The gauge is 0.75 mm² (19 AWG or 18 AWG) for the MM-GKR motor power supply cable (MR-PWS1CBL[JM-A]-[I]).

When the wiring length of the power supply cable for the MM-GKR motor exceeds 10 m, extend the cable using the MR-PWS2CBL03M-A_-L and an HIV wire of 1.25 mm² (16 AWG).

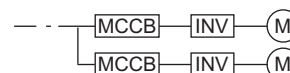

NOTE

- When the inverter capacity is larger than the motor capacity, select an MCCB and a magnetic contactor according to the inverter model, and select cables and reactors according to the motor output.
- When the breaker on the inverter's input side trips, check for wiring faults (such as short circuits) and, damage to internal parts of the inverter etc. The cause of the trip must be identified and removed before turning ON the power of the breaker.

MEMO

Precaution on Selection and Operation

● Precautions for use

◆ Safety instructions

- To use the product safely and correctly, make sure to read the "Instruction Manual" before the use.
- This product has not been designed or manufactured for use with any equipment or system operated under life-threatening conditions.
- Please contact our sales representative when considering using this product in special applications such as passenger mobile, medical, aerospace, nuclear, power or undersea relay equipment or system.
- Although this product was manufactured under conditions of strict quality control, install safety devices to prevent serious accidents when it is used in facilities where breakdowns of the product or other failures are likely to cause a serious accident.
- Do not use the inverter for a load other than the three-phase induction motor and the PM motor.
- Do not connect a IPM motor in the induction motor control settings (initial settings). Do not use an induction motor in the IPM sensorless vector control settings. It will cause a failure.

◆ Operation

- When a magnetic contactor (MC) is installed on the input side, do not use the MC for frequent starting/stopping. Otherwise the inverter may be damaged.
- When a fault occurs in the inverter, the protective function is activated to stop the inverter output. However, the motor cannot be immediately stopped. For machinery and equipment that require an immediate stop, provide a mechanical stop/holding mechanism.
- Even after turning OFF the inverter, it takes time to discharge the capacitor. Before performing an inspection, wait 10 minutes or longer after the power supply turns OFF, then check the voltage using a tester, etc.
- To maintain the security (confidentiality, integrity, and availability) of the inverter and the system against unauthorized access, DoS*1 attacks, computer viruses, and other cyberattacks from external devices via network, take appropriate measures such as firewalls, virtual private networks (VPNs), and antivirus solutions. We shall have no responsibility or liability for any problems involving inverter trouble and system trouble by DoS attacks, unauthorized access, computer viruses, and other cyberattacks.
- *1 DoS: A denial-of-service (DoS) attack disrupts services by overloading systems or exploiting vulnerabilities, resulting in a denial-of-service (DoS) state.
- For CC-Link IE TSN communication, the time required to establish communication after power-on of the master station or the inverter may vary depending on the circumstances. Normally it takes several seconds to establish communication. Depending on device status on the line, link-up processing is repeated and may increase the time.

◆ Wiring

- Applying the power to the inverter output terminals (U, V, W) causes a damage to the inverter. Before power-on, thoroughly check the wiring and sequence to prevent incorrect wiring, etc.
- Terminals P/+, P1, N/-, and PR are for connection to dedicated options and DC power supplies. Do not connect anything other than a dedicated option and DC power supply. Do not short-circuit between the frequency setting power supply terminal 10 and the common terminal 5, and between terminals PC and SD.
- To remove the wire connected to the control circuit terminal, pull the wire while pressing down the open/close button firmly with a flathead screwdriver. Otherwise, the terminal block may be damaged.
- To prevent a malfunction due to noise, keep the signal cables 10cm or more away from the power cables. Also, separate the main circuit cables at the input side from the main circuit cables at the output side.
- After wiring, wire offcuts must not be left in the inverter. Wire offcuts can cause an alarm, failure or malfunction. Always keep the inverter clean. When drilling mounting holes in an enclosure etc., take caution not to allow chips and other foreign matter to enter the inverter.
- Set the voltage/current input switch correctly. Incorrect setting may cause a fault, failure or malfunction.
- The output of the single-phase power input model is three-phase 200 V.

◆ Power supply

- When the inverter is connected near a large-capacity power transformer (500 kVA or more) or when a power factor correction capacitor is to be switched over, an excessive peak current may flow in the power input circuit, damaging the inverter. To prevent this, always install an optional AC reactor (FR-HAL).

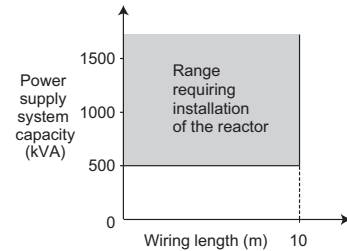

- When connecting a single-phase 100 V power input model to power transformer (exceeding 50 kVA), install an AC reactor (FR-HAL) so that the performance is more reliable.
- If surge voltage occurs in the power supply system, this surge energy may flow into an inverter, and the inverter may display the overvoltage protection (E. OV[]) and trip. To prevent this, install an optional AC reactor (FR-HAL).

◆ Installation

- Install the inverter in a clean place with no floating oil mist, cotton fly, dust and dirt, etc. Alternatively, install the inverter inside the "sealed type" enclosure that prevents entry of suspended substances. For installation in the enclosure, decide the cooling method and the enclosure size to keep the surrounding air temperature of the inverter/the converter unit within the permissible range (for specifications, refer to **page 80**).
- Some parts of the inverter/the converter unit become extremely hot. Do not install the inverter to inflammable materials (wood etc.).
- Attach the inverter vertically.

◆ Setting

- Depending on the parameter setting, high-speed operation (up to 590 Hz) is available. Incorrect setting will lead to a dangerous situation. Set the upper limit by using the upper frequency limit setting.
- Setting the DC injection brake operation voltage and operating time larger than their initial values causes motor overheating (electronic thermal O/L relay trip).
- Do not set **Pr. 70 Special regenerative brake duty** except for using the optional brake resistor. This function is used to protect the brake resistor from overheating. Do not set the value exceeding permissible duty of the brake resistor.

◆ Real sensorless vector control

- Under Real sensorless vector control, always execute offline auto tuning before starting operations.
- The speed command setting range under Real sensorless vector control is 0 to 400 Hz.
- The selectable carrier frequencies under Real sensorless vector control are 2, 6, 10, and 14 kHz.
- Torque control is not available in the low-speed (about 10 Hz or less) regenerative range, or in the low speed with the light load (about 5 Hz or less with about 20% or less of the rated torque). Select the vector control.
- The motor may start running at a low speed even when the start signal (STF or STR) is not input. The inverter with the start command ON may also rotate the motor at a low speed when the speed limit value is set to zero. Confirm that the motor running does not cause any safety problems. Under torque control, do not switch between the forward rotation command (STF) and reverse rotation command (STR). The overcurrent trip (E. OC[]) or opposite rotation deceleration fault (E.11) occurs.
- If the inverter may restart during coasting under Real sensorless vector control, set the automatic restart after instantaneous power failure function to enable frequency search (**Pr.57** ≠ "9999", **Pr.162** = "10").
- Under Real sensorless vector control, sufficient torque may not be obtained in the extremely low-speed range of about 2 Hz or less.
- The approximate speed control range is as described below.
Power drive:
1:200 (2, 4, 6 poles), 0.3 Hz or more for 60 Hz rating.
1:30 (8, 10 poles), 2 Hz or more for 60 Hz rating
Regenerative driving:
1:12 (2 to 10 poles), 5 Hz or more for 60 Hz rating

● Precautions for use of IPM motor

When using the IPM motor, the following precautions must be observed as well.

◆ ⚠ Safety instructions

- Do not use an IPM motor for an application where the motor is driven by the load

◆ Combination of motor and inverter

- For the motor capacity, the rated motor current should be equal to or less than the rated inverter current. (Note that the motor rated current should be 0.4 kW or higher (0.1 kW or higher for the 200 V class).) If a motor with substantially low rated current compared with the inverter rated current is used, speed and torque accuracies may deteriorate due to torque ripples, etc. Set the rated motor current to about 40% or higher of the inverter rated current.
- Only one IPM motor can be connected to an inverter.
- An IPM motor cannot be driven by the commercial power supply.

◆ Installation

- While power is ON or for some time after power-OFF, do not touch the motor since the motor may be extremely hot. Touching these devices may cause a burn.

◆ Wiring

- Connecting a commercial power supply to the input terminals (U, V, W) of a motor will burn it out. The motor must be connected with the output terminals (U, V, W) of the inverter.
- An IPM motor is a motor with permanent magnets embedded inside. High voltage is generated at the motor terminals while the motor is running. Before wiring or inspection, confirm that the motor is stopped. In an application, such as a fan or blower, where the motor is driven by the load, a low-voltage manual contactor must be connected at the inverter's output side, and wiring and inspection must be performed while the contactor is open. Otherwise an electric shock may be caused. The inverter power must be turned ON before closing the contacts of the contactor at the output side.
- Match the input terminals (U, V, W) of the motor and the output terminals (U, V, W) of the inverter when connecting.
- Use the following length of wiring or shorter when connecting an IPM motor.

◆ Operation

- About 0.1 s (magnetic pole detection time) takes to start a motor after inputting a start signal.
- An IPM motor is a motor with embedded permanent magnets. Regressive voltage is generated when the motor coasts at an instantaneous power failure or other incidents. The inverter's DC bus voltage increases if the motor coasts fast in this condition. When using the automatic restart after instantaneous power failure function, it is recommended to also use the regeneration avoidance operation to make startups stable.
- Thus, the relation between the rotation speed and the frequency setting is:
Rotation speed = 120 × frequency setting value / number of motor poles

◆ Connection with machine

◆ Direct connection

- When installing, align the motor shaft center and the machine shaft. Insert a liner underneath the motor or the machine legs as required to make a perfect alignment.

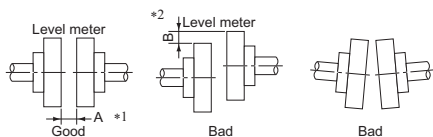

- *1 Set so that the A dimensions become the same dimension even when any position is measured by feeler gauge. (inequality in A width 3/100 mm or lower)
- *2 Do not set parts with a vertical gap like B (maximum runoff degree: 3/100 mm).

NOTE

- When a fan or blower is directly connected to the motor shaft or to the machine, the machine side may become unbalanced. When the unbalanced degree becomes larger, the motor vibration becomes larger and may result in a damage of the bearing or other area. The balance quality with the machine should meet the class G2.5 or lower of JIS B0905 (the Balance Quality Requirements of Rigid Rotors).

◆ Connected by belt

- When installing, place the motor shaft and the machine shaft in parallel, and mount them to a position where their pulley centers are aligned. Their pulley centers should also have a right angle to each shaft.
- An excessively stretched belt may damage the bearing and break the shafts. A loose belt may slip off and easily deteriorate. A flat belt should be rotated lightly when it is pulled by one hand. For details, refer to the Instruction Manual of the motor.

◆ Connected by gear couplings

Place the motor and machine shafts in parallel, and engage the gear teeth properly.

◆ Permissible vibration during operation

During operation, the motor coupled to a load machine may vibrate according to the degree of coupling between the motor and the load, and the degree of vibration created by the load. The degree of the motor's vibration varies depending on the condition of the foundations and baseplate of the motor.

If the motor has higher vibration than the permissible level, investigate the cause, take measure, and take action.

● Selection precautions

◆ Inverter capacity selection

- When operating a special motor or multiple motors in parallel by one inverter, select the inverter capacity so that 1.05 times of the total of the rated motor current becomes less than the rated output current of the inverter. (Multiple PM motors cannot be connected to an inverter.)
- Do not set **Pr. 70 Special regenerative brake duty** except for using the optional brake resistor. This function is used to protect the brake resistor from overheating. Do not set the value exceeding permissible duty of the brake resistor.

◆ Starting torque of the motor

- The starting and acceleration characteristics of the motor driven by an inverter are restricted by the overload current rating of the inverter. In general, the torque characteristic has small value compared to when the motor is started by a commercial power supply. When a large starting torque is required, and torque boost adjustment, Advanced magnetic flux vector control, Real sensorless vector control, and Vector control cannot generate the sufficient torque, increase both the motor and inverter capacities.

◆ Acceleration/deceleration time

- The motor acceleration/deceleration time is decided by the torque generated by the motor, load torque, and moment of inertia (J) of load.
- The required time may increase when the torque limit function or stall prevention function operates during acceleration/deceleration. In such a case, set the acceleration/deceleration time longer.
- To shorten the acceleration/deceleration time, increase the torque boost value (too large setting value may activate the stall prevention function, resulting in longer acceleration time at starting on the contrary). Alternatively, use Advanced magnetic flux vector control, Real sensorless vector control, or vector control, or select the larger inverter and motor capacities. To decrease the deceleration time, it is necessary to add optional brake resistor MRS type, MYS type, or FR-ABR (for the 0.4K or higher), the brake unit (FR-BU2), multifunction regeneration converter (FR-XC), or a similar device to absorb braking energy.

◆ Power transfer mechanisms (reduction gear, belt, chain, etc.)

- Caution is required for the low-speed continuous operation of the motor with an oil lubricated gear box, transmission, reduction gear, etc. in the power transfer mechanism. Such an operation may degrade the oil lubrication and cause seizing. On the other hand, the high-speed operation at more than 60 Hz may cause problems with the noise of the power transfer mechanism, life, or insufficient strength due to centrifugal force, etc. Fully take necessary precautions.

◆ Instructions for overload operation

- When performing frequent starts/stops by the inverter, rise/fall in the temperature of the transistor element of the inverter will repeat due to a repeated flow of large current, shortening the life from thermal fatigue. Since thermal fatigue is related to the amount of current, the life can be increased by reducing current at locked condition, starting current, etc. Reducing current may extend the service life but may also cause torque shortage, which leads to a start failure. Adding a margin to the current can eliminate such a condition. For an induction motor, use an inverter of a higher capacity (up to two ranks for the ND rating). For an PM motor, use an inverter and PM motor of higher capacities.

● Precautions on peripheral device selection

◆ Selection and installation of molded case circuit breaker

Install a molded case circuit breaker (MCCB) on the power receiving side to protect the wiring at the inverter input side. Select an MCCB according to the inverter power supply side power factor, which depends on the power supply voltage, output frequency and load. Refer to **page 122**. Especially for a completely electromagnetic MCCB, a slightly large capacity must be selected since its operation characteristic varies with harmonic currents. (Check the reference material of the applicable breaker.) As an earth leakage circuit breaker, use the Mitsubishi Electric earth leakage circuit breaker designed for harmonics and surge suppression. (Refer to **page 121**.)

When installing a molded case circuit breaker on the inverter output side, contact the manufacturer of each product for selection.

◆ Handling of the input side magnetic contactor (MC)

- For the operation using external terminals (using terminal STF or STR), install the input-side magnetic contactor to prevent accidents due to automatic restart when the power is restored after power failures such as an instantaneous power failure, or for safety during maintenance works. Do not use this magnetic contactor for frequent starting/stopping of the inverter. (The switching life of the converter part is about 1 million times.) In the operation by parameter unit, the automatic restart after power restoration is not performed and the magnetic contactor cannot be used to start the motor. The input-side magnetic contactor can stop the motor. However, the regenerative brake of the inverter does not operate, and the motor coasts to a stop.
- Installation of a magnetic contactor at the input side is recommended. A magnetic contactor avoids overheat or burnout of a brake resistor when heat capacity of the resistor is insufficient or a brake regenerative transistor is damaged with short while connecting an optional brake resistor. In this case, shut-off the magnetic contactor when fault occurs and inverter trips.

◆ Handling of the output side magnetic contactor (MC)

- Switch the MC between the inverter and motor only when both the inverter and motor are at a stop. When the magnetic contactor is turned ON while the inverter is operating, overcurrent protection of the inverter and such will activate. When an MC is provided to switch to a commercial power supply, switch it ON/OFF after the inverter and motor have stopped.
- Do not install a magnetic contactor at the inverter's output side when using a PM motor.

◆ Installation of thermal relay

In order to protect the motor from overheating, the inverter has an electronic thermal O/L relay. However, install an external thermal overcurrent relay (OCR) between the inverter and motors to operate several motors or a multi-pole motor with one inverter. In this case, set 0 A to the electronic thermal O/L relay setting of the inverter. For the external thermal overcurrent relay, determine the setting value in consideration of the current indicated on the motor's rating plate and the line-to-line leakage current. (**Refer to page 129**.)

Self cooling ability of a motor reduces in the low-speed operation. Installation of a thermal protector or a use of a motor with built-in thermistor is recommended.

◆ Output side measuring instrument

When the inverter-to-motor wiring length is long, especially for the 400 V class, small-capacity models, the meters and CTs may generate heat due to line-to-line leakage current. Therefore, choose the equipment which has enough allowance for the current rating.

When measuring and displaying the output voltage and output current of the inverter, use of terminals AM and 5 output function of the inverter is recommended.

◆ Disuse of power factor improving capacitor (power factor correction capacitor)

The power factor improving capacitor and surge absorber on the inverter output side may be overheated or damaged by the harmonic components of the inverter output. Also, since an excessive current flows in the inverter to activate overcurrent protection, do not provide a capacitor and surge absorber. To improve the power factor, use an AC reactor (on **page 101**), a DC reactor (on **page 102**), or a high power factor converter (on **page 115**).

◆ Electrical corrosion of the bearing

When a motor is driven by the inverter, axial voltage is generated on the motor shaft, which may cause electrical corrosion of the bearing in rare cases depending on the wiring, load, operating conditions of the motor or specific inverter settings (high carrier frequency, use of a capacitive filter *1). Contact your sales representative to take appropriate countermeasures for the motor.

The following shows examples of countermeasures for the inverter.

- Decrease the carrier frequency.
- Remove the capacitive filter.
- Provide a common mode choke on the output side of the inverter.*2
(This is effective regardless of the use of the capacitive filter.)

- *1 Mitsubishi Electric capacitive filter: FR-BIF, SF[], FR-E5NF-[], FR-S5NFS[A], FR-BFP2-[]
- *2 Recommended common mode choke: FT-3KM F series FINEMET® common mode choke cores manufactured by Hitachi Metals, Ltd.
FINEMET is a registered trademark of Hitachi Metals, Ltd.

◆ Cable gauge and wiring distance

If the wiring distance is long between the inverter and motor, during the output of a low frequency in particular, use a large cable gauge for the main circuit cable to suppress the voltage drop to 2% or less. (The table on page 122 indicates a selection example for the wiring length of 20 m.)

Especially for long-distance wiring or wiring with shielded cables, the inverter may be affected by a charging current caused by stray capacitances of the wiring, leading to an incorrect activation of the overcurrent protective function. Refer to the maximum wiring length shown in the following table. (When multiple motors are connected, use the total wiring length shown in the table or shorter)

Cable type	Pr.72 setting (carrier frequency)	Voltage class	0.1K	0.2K	0.4K	0.75K	1.5K	2.2K	3.7K or higher
			Unshielded	1 (1 kHz) or lower	100V 200V	200	200	300	500
Unshielded	2 (2 kHz)	100V 200V	30	100	200	300	500	500	500
		400V	-	-	30	100	200	200	500
Shielded	1 (1 kHz) or lower	100V 200V	50	50	75	100	100	100	100
		400V	-	-	50	50	75	100	100
Shielded	2 (2 kHz)	100V 200V	10	25	50	75	100	100	100
		400V	-	-	10	25	50	75	100

When using the automatic restart after instantaneous power failure function with wiring length exceeding 100m, select without frequency search (Pr.162 = "1, 11").

When the operation panel is installed away from the inverter and when the parameter unit is connected, use a recommended connection cable.

For the remote operation using analog signals, keep the control cable distance between the operation signal transmitter and the inverter to 30 m or less. Also, to prevent induction from other devices, keep the wiring away from the power circuits (main circuit and relay sequential circuit).

When the frequency setting is performed using the external potentiometer, not using the parameter unit, use a shielded or twisted cable as shown in the figure below. Connect the shield cable to terminal 5, not to the earth (ground).

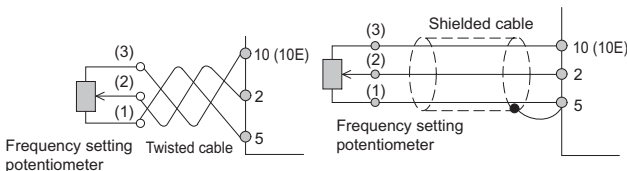

◆ Earth (ground)

When the inverter is set for the low acoustic noise operation, the leakage current increases compared to in the normal operation due to the high speed switching operation. Always earth (ground) the inverter and the motor. Also, always use the earth (ground) terminal of the inverter for earthing (grounding). (Do not use a case or chassis.)

◆ Electromagnetic interference (EMI)

For the low acoustic noise operation with high carrier frequency, electromagnetic noise tends to increase. Take countermeasures by referring to the following examples. Depending on an installation condition, noise may affect the inverter also in the normal operation (initial status).

- Decrease the carrier frequency (Pr.72) setting to lower the EMI level.
- As measures against AM radio broadcasting noise, radio noise filter FR-BIF produces an effect.
- As measures against sensor malfunction, line noise filter FRBSF01, FR-BLF produces an effect.
- For effective reduction of induction noise from the power cable of the inverter, secure the distance of 30 cm (at least 10 cm) from the power line and use a shielded twisted pair cable for the signal cable. Do not earth (ground) the shield, and connect the shield to a common terminal by itself.

EMI measure example

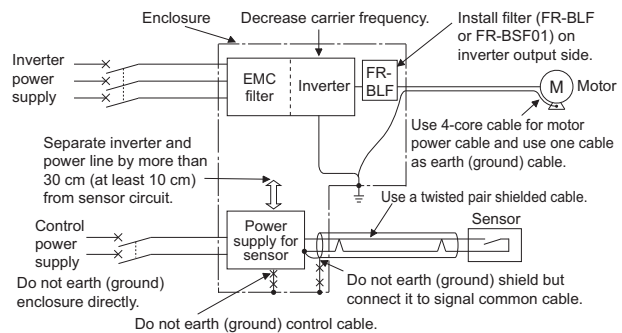

◆ Leakage current

Capacitances exist between the I/O cables or other cables of the inverter or the converter unit and earth, and in the motor, through which a leakage current flows. The amount of current leakage depends on the factors such as the size of the capacitance and the carrier frequency. Low acoustic noise operation at an increased carrier frequency of the inverter will increase current leakage. Take the following precautions to prevent current leakage. Earth leakage circuit breakers should be selected based on their rated current sensitivity, independently of the carrier frequency setting.

◆ To-earth (ground) leakage currents

Type	Influence and countermeasure
Influence and precautions	<ul style="list-style-type: none"> • Leakage currents may flow not only into the power system of the inverter but also into other power systems through the earthing (grounding) cable, etc. These leakage currents may operate earth leakage circuit breakers and earth leakage relays unnecessarily. <p>Precautions</p> <ul style="list-style-type: none"> • If the carrier frequency setting is high, decrease the Pr.72 PWM frequency selection setting. However, the motor noise increases. Selecting Pr.240 Soft-PWM operation selection makes the sound inoffensive. • By using earth leakage circuit breakers designed to suppress harmonics and surge voltage in the power system of the inverter and other devices, operation can be performed with the carrier frequency kept high (with low noise).
Transmission path	

◆ Line-to-line leakage current

Type	Influence and countermeasure
Influence and precautions	<ul style="list-style-type: none"> Line-to-line leakage current flows through the capacitance between the inverter/the converter unit output lines. Harmonic component of the leaked current may cause unnecessary operation of an external thermal relay. Long wiring length (50 m or longer) for the 400V class small capacity models (7.5 kW or lower) will increase the rate of leakage current against the rated motor current. In such a case, an unnecessary operation of the external thermal relay may be more liable to occur. <p>Precautions</p> <ul style="list-style-type: none"> Use Pr.9 Electronic thermal O/L relay. If the carrier frequency setting is high, decrease the Pr.72 PWM frequency selection setting. However, the motor noise increases. Selecting Pr.240 Soft-PWM operation selection makes the sound inoffensive. <p>To protect motor securely without being subject to the influence of the line-to-line leakage current, direct detection of the motor temperature using a temperature sensor is recommended.</p>
Transmission path	<p>Line-to-line leakage currents path</p>

◆ Harmonic Suppression Guidelines

Inverters have a converter section (rectifier circuit) and generate a harmonic current.

Harmonic currents flow from the inverter to a power receiving point via a power transformer. The Harmonic Suppression Guidelines was established to protect other consumers from these outgoing harmonic currents.

The three-phase 200 V input specifications 3.7 kW or lower (or single-phase 200 V input specifications 2.2 kW or lower and single-phase 100 V input specifications 0.75 kW or lower) were previously covered by the Harmonic Suppression Guidelines for Household Appliances and General-purpose Products and other models were covered by the Harmonic Suppression Guidelines for Consumers Who Receive High Voltage or Special High Voltage. However, the transistorized inverter has been excluded from the target products covered by the Harmonic Suppression Guidelines for Household Appliances and General-purpose Products in January 2004 and the Harmonic Suppression Guideline for Household Appliances and General-purpose Products was repealed on September 6, 2004.

All capacity and all models of general-purpose inverter used by specific consumers are now covered by the "Harmonic Suppression Guidelines for Consumers Who Receive High Voltage or Special High Voltage".

- "Harmonic Suppression Guidelines for Consumers Who Receive High Voltage or Special High Voltage"
This guideline sets the maximum values of outgoing harmonic currents generated from a high-voltage or specially high-voltage receiving consumer who will install, add or renew harmonic generating equipment. If any of the maximum values is exceeded, this guideline requires that consumer to take certain suppression measures.

The users who are not subjected to the above guidelines do not need follow the guidelines, but the users are recommended to connect a DC reactor and an AC reactor as usual.

Compliance with the "Harmonic Suppression Guidelines for Consumers Who Receive High Voltage or Special High Voltage"

Input power	Target capacity	Countermeasure
Single-phase 100V Single-phase 200 V Three-phase 200 V Three-phase 400 V	All capacities	Confirm the compliance with the "Harmonic Suppression Guidelines for Consumers Who Receive High Voltage or Special High Voltage" published in September 1994 by the Ministry of International Trade and Industry (the present Japanese Ministry of Economy, Trade and Industry). Take countermeasures if required. Use the following materials as reference to calculate the power supply harmonics. Reference materials "Harmonic Suppression Measures of the General-purpose Inverter" January 2004, Japan Electrical Manufacturers' Association "Calculation Method of Harmonic Current of the General-purpose Inverter Used by Specific Consumers" JEM-TR201 (Revised in December 2003), Japan Electrical Manufacturers' Association

For compliance to the "Harmonic Suppression Guideline of the General-purpose Inverter (Input Current of 20A or Less) for Consumers Other Than Specific Consumers" published by JEMA

Input power	Target capacity	Measures
Single-phase 100 V	0.75kW or lower	Connect the AC reactor or DC reactor recommended in the Catalogs and Instruction Manuals.
Single-phase 200 V	2.2kW or lower	Reference materials "Harmonic Suppression Guideline of the General-purpose Inverter (Input Current of 20A or Less)"
Three-phase 200 V	3.7 kW or lower	JEM-TR226 (Published in December 2003), Japan Electrical Manufacturers' Association

◆ Calculation of outgoing harmonic current

Outgoing harmonic current = fundamental wave current (value converted from received power voltage) × operation ratio × harmonic content

- Operation ratio: Operation ratio = actual load factor × operation time ratio during 30 minutes
- Harmonic content: Found in the table below.

- Harmonic contents (values when the fundamental wave current is 100%)

	Reactor	5th	7th	11th	13th	17th	19th	23rd	25th
Three-phase bridge (capacitor smoothing)	Not used	65	41	8.5	7.7	4.3	3.1	2.6	1.8
	Used (AC side)	38	14.5	7.4	3.4	3.2	1.9	1.7	1.3
	Used (DC side)	30	13	8.4	5.0	4.7	3.2	3.0	2.2
	Used (AC, DC sides)	28	9.1	7.2	4.1	3.2	2.4	1.6	1.4
Single-phase bridge (capacitor smoothing, full-wave rectification)	Not used	60	33.5	6.1	6.4	2.6	2.7	1.5	1.5
	Used (AC side)	31.9	8.3	3.8	3.0	1.7	1.4	1.0	0.7

- Rated capacities and outgoing harmonic currents when driven by inverter

Applied motor (kW)	Fundamental wave current (A)		Fundamental wave current converted from 6.6 kV (mA)	Rated capacity (kVA)	Outgoing harmonic current converted from 6.6 kV (mA) (No reactor, 100% operation ratio)								
	200 V	400 V			5th	7th	11th	13th	17th	19th	23rd	25th	
0.4	1.61	0.81	49	0.57	31.85	20.09	4.165	3.773	2.107	1.519	1.274	0.882	
0.75	2.74	1.37	83	0.97	53.95	34.03	7.055	6.391	3.569	2.573	2.158	1.494	
1.5	5.50	2.75	167	1.95	108.6	68.47	14.20	12.86	7.181	5.177	4.342	3.006	
2.2	7.93	3.96	240	2.81	156.0	98.40	20.40	18.48	10.32	7.440	6.240	4.320	
3.7	13.0	6.50	394	4.61	257.1	161.5	33.49	30.34	16.94	12.21	10.24	7.092	
5.5	19.1	9.55	579	6.77	376.1	237.4	49.22	44.58	24.90	17.95	15.05	10.42	
7.5	25.6	12.8	776	9.07	504.4	318.2	65.96	59.75	33.37	24.06	20.18	13.97	
11	36.9	18.5	1121	13.1	728.7	459.6	95.29	86.32	48.20	34.75	29.15	20.18	
15	49.8	24.9	1509	17.6	980.9	618.7	128.3	116.2	64.89	46.78	39.24	27.16	
18.5	61.4	30.7	1860	21.8	1209	762.6	158.1	143.2	79.98	57.66	48.36	33.48	
22	73.1	36.6	2220	25.9	1443	910.2	188.7	170.9	95.46	68.82	57.72	39.96	
30	98.0	49.0	2970	34.7	1931	1218	252.5	228.7	127.7	92.07	77.22	53.46	

- Conversion factors

Classification	Circuit type		Conversion coefficient Ki
3	Three-phase bridge (Capacitor smoothing)	Without reactor	K31 = 3.4
		With reactor (AC side)	K32 = 1.8
		With reactor (DC side)	K33 = 1.8
		With reactors (AC, DC sides)	K34 = 1.4
4	Single-phase bridge (capacitor smoothing, full-wave rectification)	Without reactor	K43=2.9
		With reactor (AC side)	K44=1.3
5	Self-excitation three-phase bridge	When a high power factor converter is used	K5 = 0

Compatible Motors

● List of applicable inverter models by rating (motor capacity → inverter model)

◆ 200 V class

Motor capacity (kW)*1	DC reactor	LD			ND			ND		
	FR-HEL-□	Model FR-E820-□	Rated current (A)	Model FR-E820-□	Rated current (A)	Model FR-E820S-□	Rated current (A)			
0.1	0.4K*2	0.1K	0008	1.3	0.1K	0008	0.8	0.1K	0008	0.8
0.2	0.4K*2	0.1K	0008	1.3	0.2K	0015	1.5	0.2K	0015	1.5
0.4	0.4K	0.2K	0015	2	0.4K	0030	3	0.4K	0030	3
0.75	0.75K	0.4K	0030	3.5	0.75K	0050	5	0.75K	0050	5
1.1	1.5K	0.75K	0050	6	1.5K	0080	8	1.5K	0080	8
1.5	1.5K	1.5K	0080	9.6	1.5K	0080	8	1.5K	0080	8
2.2	2.2K	1.5K	0080	9.6	2.2K	0110	11	2.2K	0110	11
3	3.7K	2.2K	0110	12	3.7K	0175	17.5	-	-	-
3.7	3.7K	3.7K	0175	19.6	3.7K	0175	17.5	-	-	-
5.5	5.5K	3.7K	0175	19.6	5.5K	0240	24	-	-	-
7.5	7.5K	5.5K	0240	30	7.5K	0330	33	-	-	-
11	11K	7.5K	0330	40	11K	0470	47	-	-	-
15	15K	11K	0470	56	15K	0600	60	-	-	-
18.5	18.5K	15K	0600	69	18.5K	0760	76	-	-	-
22	22K	18.5K	0760	88	22K	0900	90	-	-	-
30	30K	22K	0900	115	-	-	-	-	-	-

◆ 400 V class

Motor capacity (kW)*1	DC reactor	LD			ND		
	FR-HEL-□	Model FR-E840-□	Rated current (A)	Model FR-E840-□	Rated current (A)		
0.4	H0.4K	0.4K	0016	2.1	0.4K	0016	1.6
0.75	H0.75K	0.4K	0016	2.1	0.75K	0026	2.6
1.5	H1.5K	0.75K	0026	3.5	1.5K	0040	4
2.2	H2.2K	1.5K	0040	5.5	2.2K	0060	6
3	H3.7K	2.2K	0060	6.9	3.7K	0095	9.5
3.7	H3.7K	3.7K	0095	11.1	3.7K	0095	9.5
5.5	H5.5K	3.7K	0095	11.1	5.5K	0120	12
7.5	H7.5K	5.5K	0120	17.5	7.5K	0170	17
11	H11K	7.5K	0170	23	11K	0230	23
15	H15K	11K	0230	35	15K	0300	30
18.5	H18.5K	15K	0300	41	18.5K	0380	38
22	H22K	18.5K	0380	45	22K	0440	44
30	H30K	22K	0440	60	-	-	-

◆ 575 V class

Motor capacity (kW)*1	LD			ND		
	Model FR-E860-□	Rated current (A)	Model FR-E860-□	Rated current (A)		
0.75	-	-	0.75K	0017	1.7	
1.5	0.75K	0017	1.5K	0027	2.7	
2.2	1.5K	0027	2.2K	0040	4	
3.7	2.2K	0040	3.7K	0061	6.1	
5.5	3.7K	0061	5.5K	0090	9	
7.5	5.5K	0090	7.5K	0120	12	
11	7.5K	0120	-	-	-	

◆ 100 V class

Motor capacity (kW)*1	ND		
	Model FR-E810W-□	Rated current (A)	
0.1	0.1K	0008	0.8
0.2	0.2K	0015	1.5
0.4	0.4K	0030	3
0.75	0.75K	0050	5

*1 The motor capacity indicates the maximum capacity of a standard 4-pole motor driven by all of the inverters in parallel connection. To drive a Mitsubishi Electric high-performance energy-saving motor, use the 200 V class 0.75K inverter for a 1.1 kW motor, or 200/400 V class 2.2K inverter for a 3 kW motor.

*2 The power factor may be slightly lower.

◆ Overload current rating

LD	120% 60 s, 150% 3 s (inverse-time characteristics) at surrounding air temperature of 50°C
ND	150% 60 s, 200% 3 s (inverse-time characteristics) at surrounding air temperature of 50°C

● **Application to constant-torque motors**

◆ **SF-HRCA type**

- Continuous operation even at low speed of 0.3 Hz is possible (when using Real sensorless vector control).
The load torque is not needed to be reduced even at a low speed and constant torque (100% torque) continuous operation is possible within the range of speed ratio 1/20 (3 to 60 Hz) (except for the 22K model).
(The characteristic of motor running at 60 Hz or higher is that output torque is constant.)
The continuous operation torque for the single-phase 100 V power input models is approx. 90% of the described value.
- Installation size is the same as that of the standard motor.
- Note that operation characteristic in the chart below cannot be obtained if V/F control is used.

◆ **Standard specifications (indoor type)**

Output (kW)	Number of poles	Frequency range	Common specification
0.4	4	3 to 120 Hz	Base frequency 60 Hz • Rotation direction (CCW) Counterclockwise when viewed from the motor end • Lead wire 3.7 kW or lower: 3 wires 5.5 kW or higher: 6 or 12 wires • Surrounding air temperature: 40°C or lower The protective structure is IP44.
0.75			
1.5			
2.2			
3.7			
5.5			
7.5			
11			
15			
18.5			
22	3 to 100 Hz		
30			

◆ **Motor torque**

The following shows torque characteristics of the motor in combination with the inverter with the ND rating. The overload capacity decreases for the LD rating. Observe the specified range of the inverter.

◆ **Continuous rated range of use (Real sensorless vector control)**

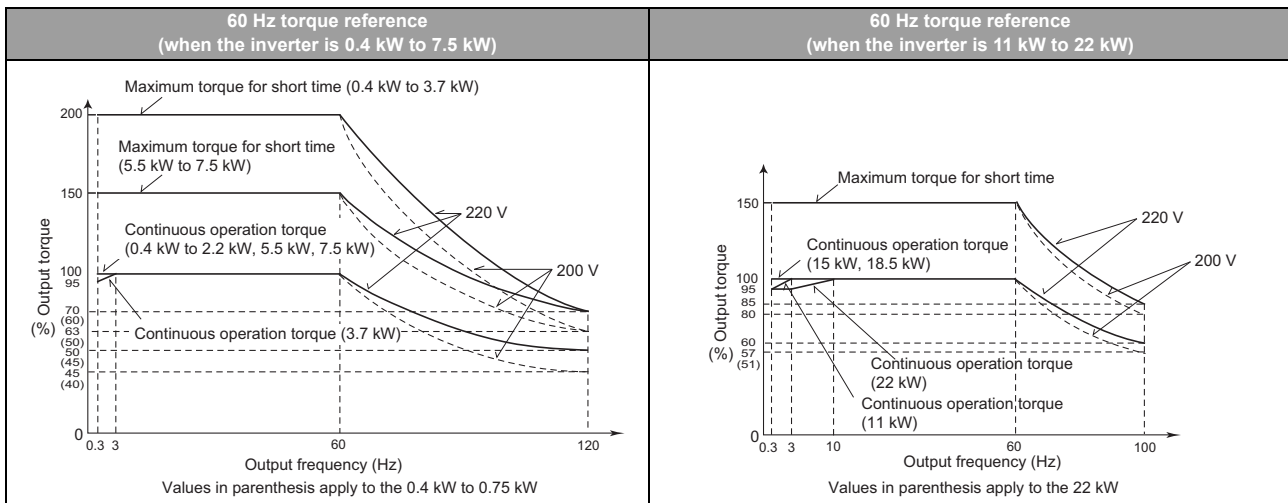

The maximum short-time torque indicates the maximum torque characteristics within 60 s.
For the motor constant under Real sensorless vector control, please contact your sales representative.

● Application to vector control dedicated motors (SF-V5RU)

For performing vector control, the FR-A8AP E kit (vector control compatible option) is required.
A 12 V or 24 V power supply is required as the power supply for the encoder of the SF-V5RU.

◆ Motor torque

When the vector control dedicated motor (SF-V5RU) and inverter are used, the torque characteristics are as shown below.
It is assumed that the motor is used in combination with an inverter with the ND rating. The overload capacity decreases when the LD rating is selected. Observe the specified range of the inverter.

- SF-V5RU

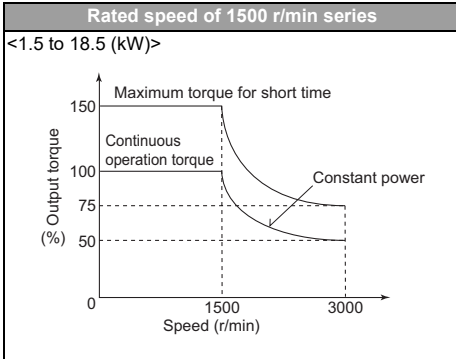

- The SF-V5RU-3.7kW or lower can be operated with the maximum rotation speed of 3600 r/min. For the use of those motors, please contact your sales representative.
- The maximum rotation speed of motors with a brake is 1800 r/min.

◆ Motor model

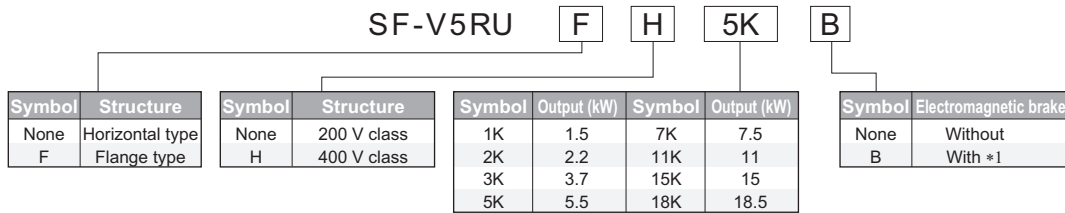

*1 Since a brake power device is a stand-alone, install it inside the enclosure. (This device should be arranged at the customer side.)

◆ Model lineup (●: Available model, -: Not available)

- Rated speed: 1500 r/min (4 poles)

Model	Standard type	Rated output (kW)									
		1.5	2.2	3.7	5.5	7.5	11	15	18.5		
Standard horizontal type	SF-V5RU(H)[]	●	●	●	●	●	●	●	●	●	
Flange type	SF-V5RUF(H)[]	●	●	●	●	●	●	●	●	●	
Standard horizontal type with brake	SF-V5RU(H)[]B	●	●	●	●	●	●	●	●	●	
Flange type with brake	SF-V5RUF(H)[]B	●	●	●	●	●	●	●	●	-	

◆ Motor specifications

- 200 V class (Mitsubishi Electric dedicated motor [SF-V5RU (1500 r/min series)])

Motor type SF-V5RU[JK	1	2	3	5	7	11	15	18
Applicable inverter model FR-E820-[JK (ND rating)	2.2	3.7	5.5	7.5	11	15	18.5	22
Rated output (kW)	1.5	2.2	3.7	5.5	7.5	11	15	18.5
Rated current (A)	8.5	11.5	17.6	28.5	37.5	54	72.8	88
Rated torque (N·m)	9.55	14.1	23.6	35.0	47.7	70.0	95.5	118
Maximum torque 150% 60 s (N·m)	14.3	21.1	35.4	52.4	71.6	105	143	176
Rated speed (r/min)	1500							
Maximum speed (r/min)	3000 *1							
Frame No.	90L	100L	112M	132S	132M	160M	160L	180M
Inertia moment J ($\times 10^{-4}$ kg·m ²)	67.5	105	175	275	400	750	875	1725
Noise *4	75 dB or less							
Cooling fan (with thermal protector) *6*7	Voltage	Single-phase 200 V/50 Hz Single-phase 200 V to 230 V/60 Hz				Three-phase 200 V/50 Hz Three-phase 200 to 230 V/60 Hz		
	Input *2	36/55 W (0.26/0.32 A)		22/28 W (0.11/0.13 A)		55/71 W (0.39/0.39 A)		
	Recommended thermal setting	0.36 A		0.18 A		0.51 A		
Surrounding air temperature, humidity	-10 to +40°C (non-freezing), 90%RH or less (non-condensing)							
Structure (Protective structure)	Totally enclosed forced draft system (Motor: IP44, cooling fan: IP23S) *3							
Detector	Encoder 2048P/R, A phase, B phase, Z phase +12 V/24 VDC power supply *5							
Equipment	Encoder, thermal protector, fan							
Heat resistance class	F							
Vibration rank	V10							
Approx. mass (kg)	24	33	41	52	62	99	113	138

- 400 V class (Mitsubishi Electric dedicated motor [SF-V5RUH (1500 r/min series)])

Motor type SF-V5RUH[JK	1	2	3	5	7	11	15	18
Applicable inverter model FR-E840-[JK (ND rating)	2.2	2.2	3.7	7.5	11	15	18.5	22
Rated output (kW)	1.5	2.2	3.7	5.5	7.5	11	15	18.5
Rated current (A)	4.2	5.8	8.8	14.5	18.5	27.5	35.5	44
Rated torque (N·m)	9.55	14.1	23.6	35.0	47.7	70.0	95.5	118
Maximum torque 150% 60 s (N·m)	14.3	21.1	35.4	52.4	71.6	105	143	176
Rated speed (r/min)	1500							
Maximum speed (r/min)	3000 *1							
Frame No.	90L	100L	112M	132S	132M	160M	160L	180M
Inertia moment J ($\times 10^{-4}$ kg·m ²)	67.5	105	175	275	400	750	875	1725
Noise *4	75 dB or less							
Cooling fan (with thermal protector) *6*7	Voltage	Single-phase 200 V/50 Hz Single-phase 200 V to 230 V/60 Hz				Three-phase 380 to 400 V/50 Hz Three-phase 400 to 460 V/60 Hz		
	Input *2	36/55 W (0.26/0.32 A)		22/28 W (0.11/0.13 A)		55/71 W (0.19/0.19 A)		
	Recommended thermal setting	0.36 A		0.18 A		0.25 A		
Surrounding air temperature, humidity	-10 to +40°C (non-freezing), 90%RH or less (non-condensing)							
Structure (Protective structure)	Totally enclosed forced draft system (Motor: IP44, cooling fan: IP23S) *3							
Detector	Encoder 2048P/R, A phase, B phase, Z phase +12 V/24 VDC power supply *5							
Equipment	Encoder, thermal protector, fan							
Heat resistance class	F							
Vibration rank	V10							
Approx. mass (kg)	24	33	41	52	62	99	113	138

*1 A dedicated motor of 3.7 kW or less can be run at the maximum speed of 3600 r/min. Consult our sales office when using the motor at the maximum speed.

*2 Power (current) at 50 Hz/60 Hz.

*3 Since a motor with brake has a window for gap check, the protective structure of both the cooling fan section and brake section is IP20. S of IP23S is an additional code indicating the condition that protection from water intrusion is established only when a cooling fan is not operating.

*4 The value when high carrier frequency is set (Pr.72 = 6, Pr.240 = 0).

*5 The 12 V/24 V power supply is required as the power supply for the encoder. (When the FR-A8TP is used, the 24 V power supply of the FR-A8TP can be used for the encoder of the SF-V5RU.)

*6 The cooling fan is equipped with a thermal protector. The cooling fan stops when the coil temperature exceeds the specified value in order to protect the fan motor. A restrained cooling fan or degraded fan motor insulation could be causes for the rise in coil temperature. The cooling fan re-starts when the coil temperature drops to normal.

*7 The cooling fan voltage and input values are the basic specifications of the cooling fan alone and free air values. The input value becomes slightly larger when it is rotated by this motor due to an increased workload, but the cooling fan can be used as it is. When preparing a thermal relay at the user side, use the recommended thermal setting.

◆ Dedicated motor outline dimension drawings (standard horizontal type)

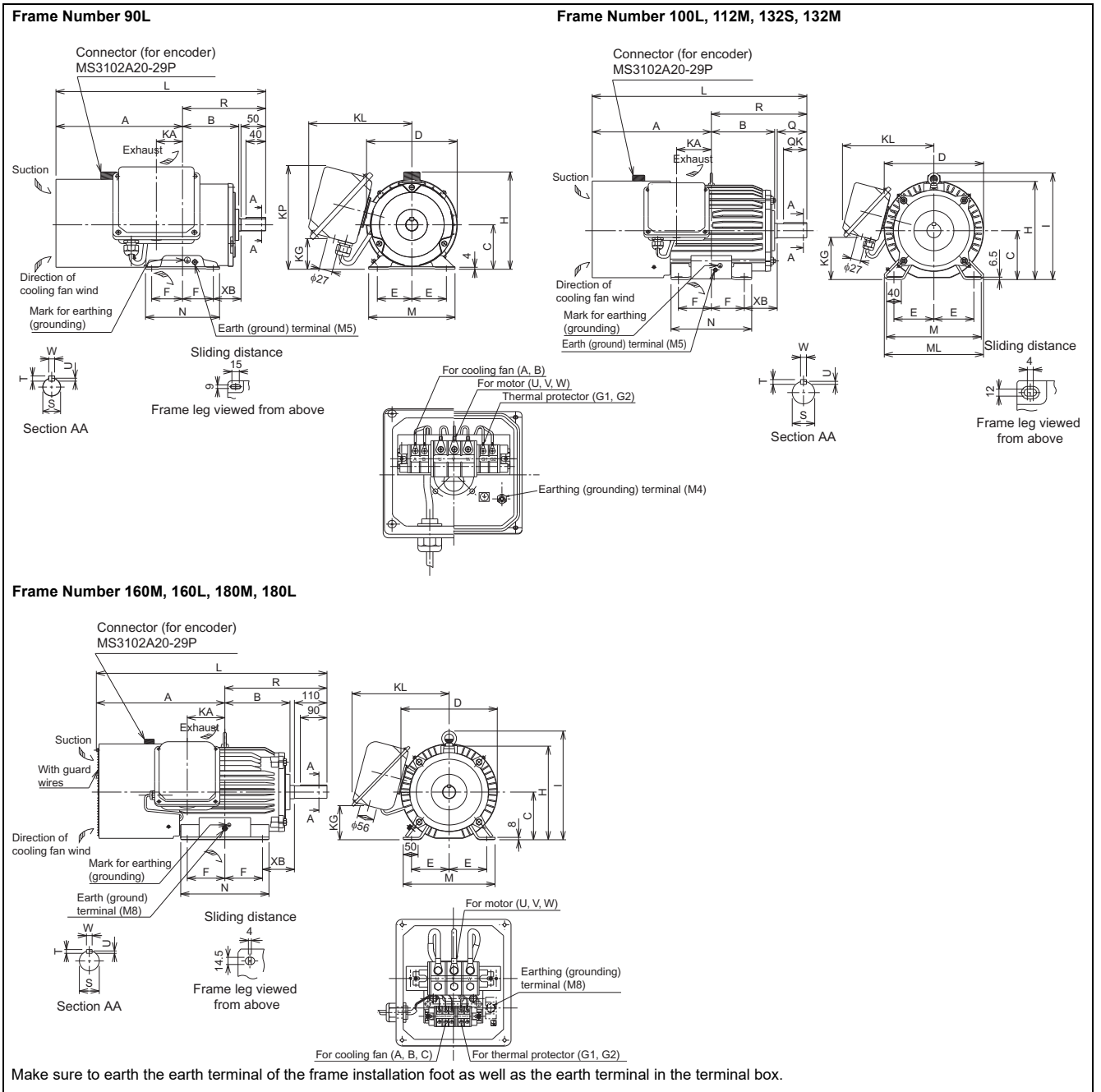

• Dimensions table

(Unit: mm)

SF-V5RU[K]	Frame No.	Mass (kg)	Motor																		Terminal screw size							
			A	B	C	D	E	F	H	I	KA	KG	KL (KP)	L	M	ML	N	XB	Q	QK	R	S	T	U	W	U, V, W	A, B, (C)	G1, G2
1	90L	24	256.5	114	90	183.6	70	62.5	198	—	53	65	220 (210)	425	175	—	150	56	—	—	168.5	24j6	7	4	8	M6	M4	M4
2	100L	33	284	128	100	207	80	70	203.5	230	65	78	231	477	200	212	180	63	60	45	193	28j6	7	4	8	M6	M4	M4
3	112M	41	278	135	112	228	95	70	226	253	69	93	242	478	230	242	180	70	60	45	200	28j6	7	4	8	M6	M4	M4
5	132S	52	303	152	132	266	108	70	265	288	75	117	256	542	256	268	180	89	80	63	239	38k6	8	5	10	M6	M4	M4
7	132M	62	322	171	132	266	108	89	265	288	94	117	256	580	256	268	218	89	80	63	258	38k6	8	5	10	M6	M4	M4
11	160M	99	412	198	160	318	127	105	316	367	105	115	330	735	310	—	254	108	—	—	323	42k6	8	5	12	M8	M4	M4
15	160L	113	434	220	160	318	127	127	316	367	127	115	330	779	310	—	298	108	—	—	345	42k6	8	5	12	M8	M4	M4
18	180M	138	438.5	225.5	180	363	139.5	120.5	359	410	127	139	352	790	335	—	285	121	—	—	351.5	48k6	9	5.5	14	M8	M4	M4

- (a) Install the motor with a frame number 180 or larger on the floor and use it with the shaft horizontal.
- (b) Leave an enough clearance between the fan suction port and wall to ensure adequate cooling. Check that a fan blows air from the opposite load side to the load side.
- (c) The vertical tolerance for the shaft center height is ± 0.5 .
- (d) The 400 V class motor has "H" in its model name.

◆ Dedicated motor outline dimension drawings (standard horizontal type with brake)

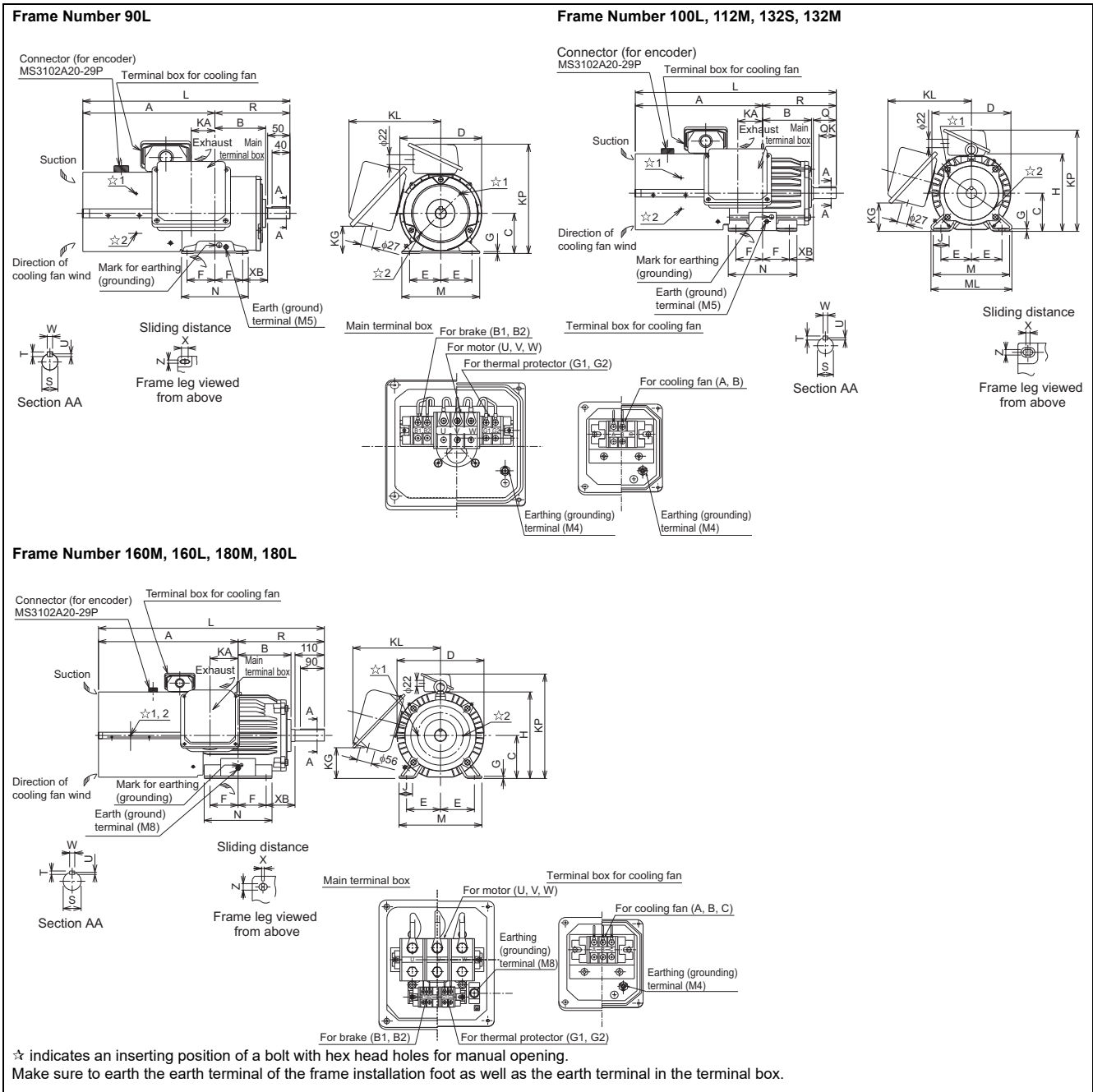

• Dimensions table

(Unit: mm)

SF-V5RU KB	Frame No.	Mass (kg)	Motor																	Shaft end					Terminal screw size										
			A	B	C	D	E	F	G	H	I	J	KA	KD	KG	KL	KP	L	M	ML	N	X	XB	Z	Q	QK	R	S	T	U	W	U, V, W	A, B, C	G1, G2	B1, B2
1	90L	29	296.5	114	90	183.6	70	62.5	4	—	53	27	65	220	245	465	175	—	150	15	56	9	50	40	168.5	24	6	7	4	8	M6	M4	M4	M4	
2	100L	46	333.5	128	100	207	80	70	6.5	—	40	65	27	78	231	265	526.5	200	212	180	4	63	12	60	45	193	28	6	7	4	8	M6	M4	M4	M4
3	112M	53	355	135	112	228	95	70	6.5	—	40	69	27	93	242	290	555	230	242	180	4	70	12	60	45	200	28	6	7	4	8	M6	M4	M4	M4
5	132S	70	416	152	132	266	108	70	6.5	—	40	75	27	117	256	329	655	256	268	180	4	89	12	80	63	239	38	6	8	5	10	M6	M4	M4	M4
7	132M	80	435	171	132	266	108	89	6.5	—	40	94	27	117	256	329	693	256	268	218	4	89	12	80	63	258	38	6	8	5	10	M6	M4	M4	M4
11	160M	140	522.5	198	160	318	127	105	8	—	50	105	56	115	330	391	845.5	310	—	254	4	108	14.5	110	90	323	42	6	8	5	12	M8	M4	M4	M4
15	160L	155	544.5	220	160	318	127	127	8	—	50	127	56	115	330	391	889.5	310	—	298	4	108	14.5	110	90	345	42	6	8	5	12	M8	M4	M4	M4
18	180M	185	568.5	225.5	180	363	139.5	120.5	8	—	50	127	56	139	352	428	920	335	—	285	4	121	14.5	110	90	351.5	48	6	9	5.5	14	M8	M4	M4	M4

- Install the motor on the floor and use it with the shaft horizontal.
- Leave an enough clearance between the fan suction port and wall to ensure adequate cooling. Check that a fan blows air from the opposite load side to the load side.
- The vertical tolerance for the shaft center height is ± 0.5 .
- The 400 V class motor has "H" in its model name.
- Since a brake power device is a stand-alone, install it inside the enclosure.

◆ Dedicated motor outline dimension drawings (flange type)

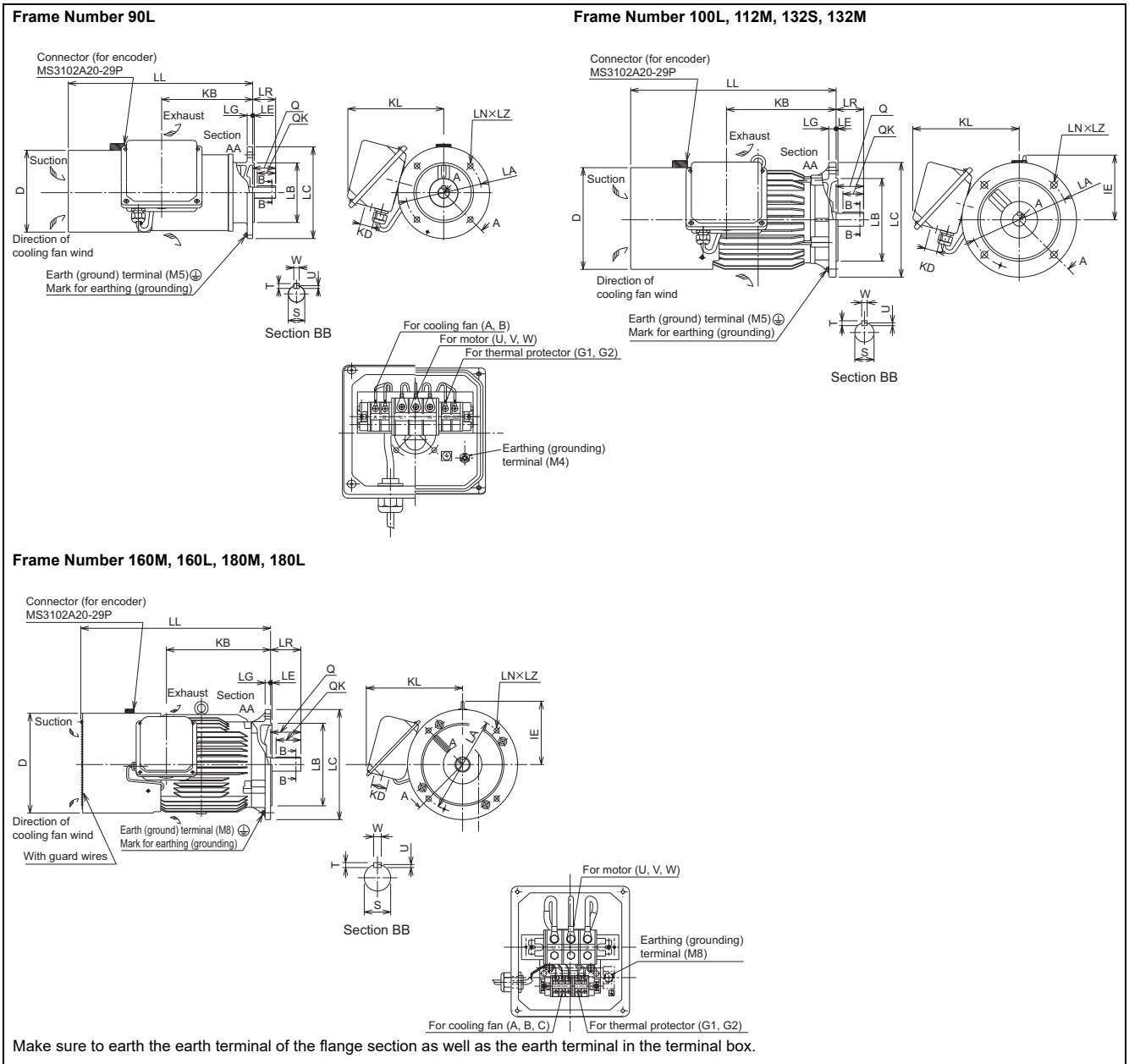

• Dimensions table

(Unit: mm)

SF-V5RU FJK	Flange No.	Frame No.	Mass (kg)	Motor													Shaft end					Terminal screw size				
				D	IE	KB	KD	KL	LA	LB	LC	LE	LG	LL	LN	LZ	LR	Q	QK	S	T	U	W	U,V,W	A,B,(C)	G1,G2
1	FF165	90L	26.5	183.6	—	198.5	27	220	165	130j6	200	3.5	12	402	4	12	50	50	40	24j6	7	4	8	M6	M4	M4
2	FF215	100L	37	207	130	213	27	231	215	180j6	250	4	16	432	4	14.5	60	60	45	28j6	7	4	8	M6	M4	M4
3	FF215	112M	46	228	141	239	27	242	215	180j6	250	4	16	448	4	14.5	60	60	45	28j6	7	4	8	M6	M4	M4
5	FF265	132S	65	266	156	256	27	256	265	230j6	300	4	20	484	4	14.5	80	80	63	38k6	8	5	10	M6	M4	M4
7	FF265	132M	70	266	156	294	27	256	265	230j6	300	4	20	522	4	14.5	80	80	63	38k6	8	5	10	M6	M4	M4
11	FF300	160M	110	318	207	318	56	330	300	250j6	350	5	20	625	4	18.5	110	110	90	42k6	8	5	12	M8	M4	M4
15	FF300	160L	125	318	207	362	56	330	300	250j6	350	5	20	669	4	18.5	110	110	90	42k6	8	5	12	M8	M4	M4
18	FF350	180M	160	363	230	378.5	56	352	350	300j6	400	5	20	690	4	18.5	110	110	90	48k6	9	5.5	14	M8	M4	M4

- (a) The motor with a frame number 180 cannot be installed on the ceiling (with the shaft facing up). For use with the shaft facing down, the protection rating of the cooling fan is IP20.
- (b) Leave an enough clearance between the fan suction port and wall to ensure adequate cooling. Check that a fan blows air from the opposite load side to the load side.
- (c) The 400 V class motor has "H" in its model name.

◆ Dedicated motor outline dimension drawings (flange type with brake)

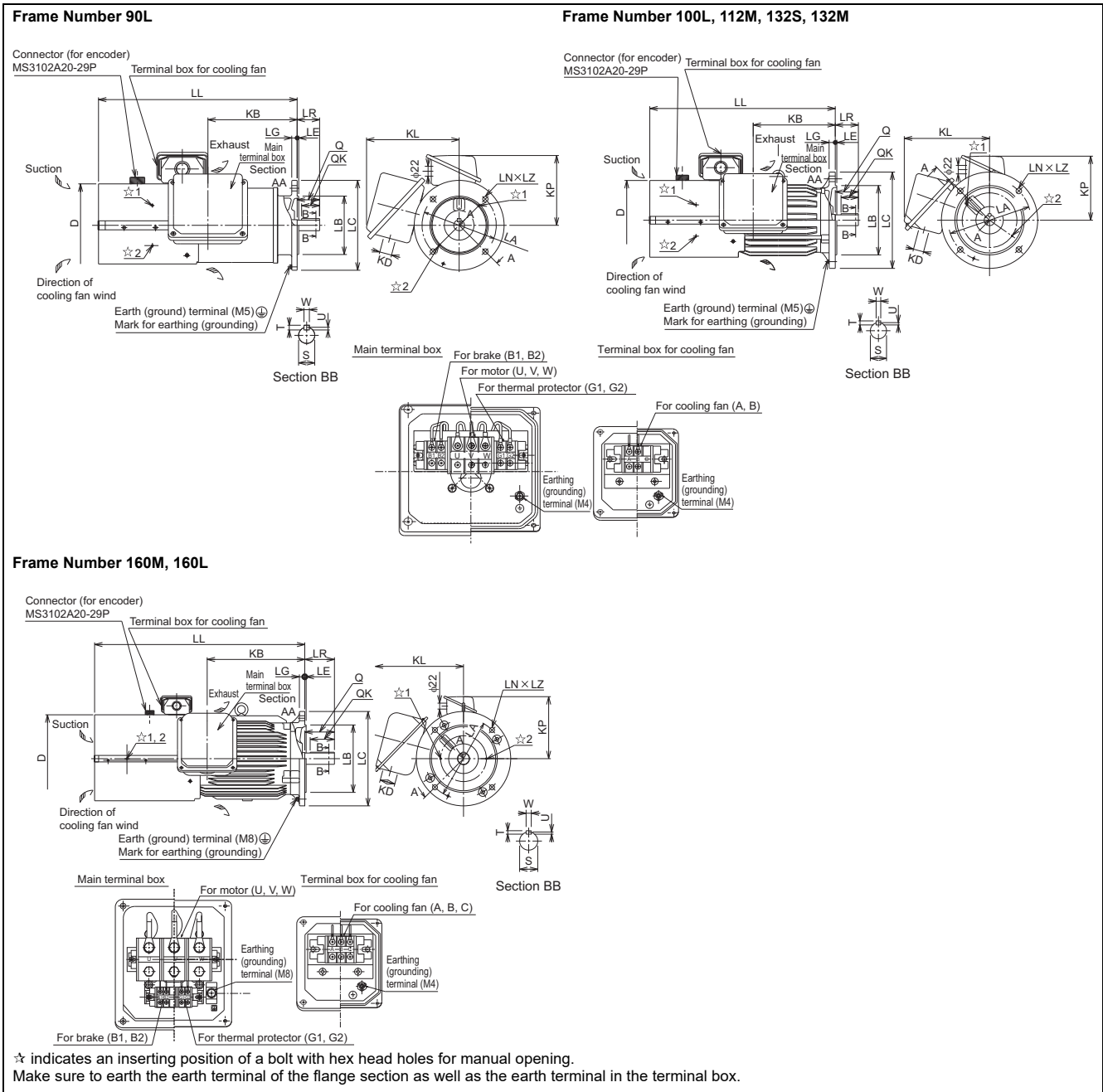

• Dimensions table

(Unit: mm)

SF-V5RU F[KB]	Flange No.	Frame No.	Mass (kg)	Motor													Shaft end					Terminal screw size					
				D	KB	KD	KL	KP	LA	LB	LC	LE	LG	LL	LN	LZ	LR	Q	QK	S	T	U	W	U,V, W	A,B, (C)	B1, B2	G1, G2
1	FF165	90L	31.5	183.6	198.5	27	220	155	165	130j6	200	3.5	12	442	4	12	50	50	40	24j6	7	4	8	M6	M4	M4	M4
2	FF215	100L	50	207	213	27	231	165	215	180j6	250	4	16	481.5	4	14.5	60	60	45	28j6	7	4	8	M6	M4	M4	M4
3	FF215	112M	58	228	239	27	242	178	215	180j6	250	4	16	525	4	14.5	60	60	45	28j6	7	4	8	M6	M4	M4	M4
5	FF265	132S	83	266	256	27	256	197	265	230j6	300	4	20	597	4	14.5	80	80	63	38k6	8	5	10	M6	M4	M4	M4
7	FF265	132M	88	266	294	27	256	197	265	230j6	300	4	20	635	4	14.5	80	80	63	38k6	8	5	10	M6	M4	M4	M4
11	FF300	160M	151	318	318	56	330	231	300	250j6	350	5	20	735.5	4	18.5	110	110	90	42k6	8	5	12	M8	M4	M4	M4
15	FF300	160L	167	318	362	56	330	231	300	250j6	350	5	20	779.5	4	18.5	110	110	90	42k6	8	5	12	M8	M4	M4	M4

- Install the motor on the wall and use it with the shaft horizontal.
- Leave an enough clearance between the fan suction port and wall to ensure adequate cooling. Check that a fan blows air from the opposite load side to the load side.
- The 400 V class motor has "H" in its model name.
- Since a brake power device is a stand-alone, install it inside the enclosure.

● IE5 compliant energy-saving high-accuracy PM motor EM-A series

The EM-A series high-performance magnet motors have Mitsubishi Electric's unique salient pole core*1 and enable positioning and speed control without using sensors.

*1 Japanese Patent No. 5646119



◆ Compact and energy-saving

- Adopting an optimal motor core shape for sensorless control reduces the volume by 50 to 60% and the mass by 30 to 50% compared with induction motors.
- This energy-saving motor is compliant with IE5 efficiency class for variable speed motors*2.

*2 Based on the efficiency standard (%) for variable speed motors (rated speed: 1801 to 6000 r/min) specified in IEC 60034-30-2.

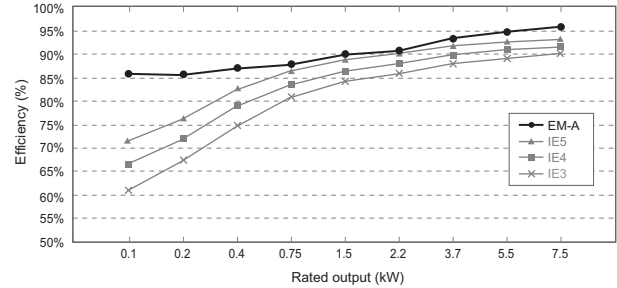

◆ Global

- This magnet motor does not need to be certified as compliant with high-efficiency standards in each country*3.
- The motor has already been certified as compliant with international safety standards (UL, CE).*4

*3 As of April 2021 (For the shipment to China, the China Energy Label must be attached to the product.)

*4 3.7 to 7.5 kW motors are to be certified.

◆ High performance

- The EM-A series enables highly accurate speed control with less speed fluctuations due to load change by using Mitsubishi Electric's unique PM sensorless vector control.
- The motor can be used for high-accuracy transport applications such as production lines of semiconductors or liquid crystals.
- Operation at stable speed under load variation is possible.
Speed fluctuation: $\pm 0.05\%$ *5
Speed control range: 1:1300
- Holding torque is generated by the servo lock function when the motor stops, preventing movements caused by external forces.
- This new salient pole type magnet motor and Mitsubishi Electric's unique high-performance sensorless control technique enable highly accurate speed control and positioning without using an encoder.
Positioning accuracy: $\pm 1.8^\circ$ *6

*5 During the load fluctuation of 0 to 100%

Speed fluctuation ratio = (actual speed - command speed) / rated speed $\times 100$ (%)

*6 Accuracy when the input voltage is 200 VAC, wiring length is 5 m or less, and the position accuracy compensation gain tuning is performed.

[Operation torque characteristics]

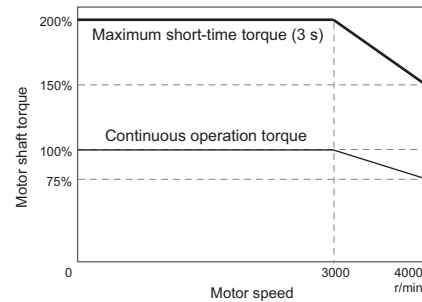

When the input voltage is low, the torque may be reduced.

The continuous operation torque is 90% at 10 r/min or less (for 1.5 kW or higher). When driving the motor under high load in a low-speed range (especially at 15 r/min or lower for 0.75 kW or lower, or at 10 r/min or lower for 1.5 kW or higher), the protective function by electronic thermal O/L relay (E.THT, ETHM) may be activated and the short time operation range torque may not be generated.

◆ Lineup

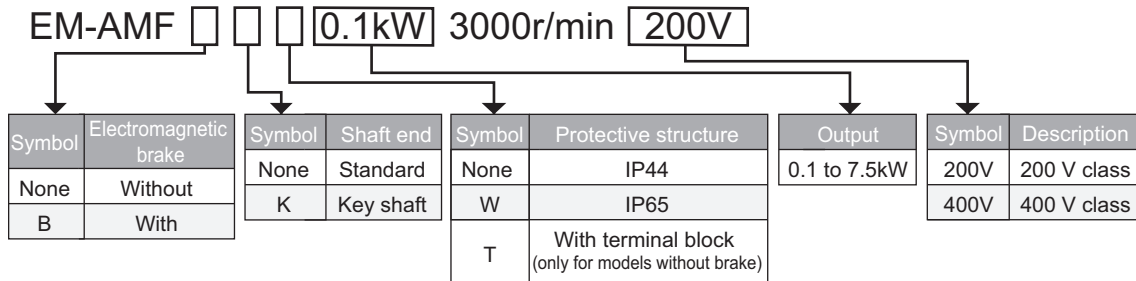

◆ Compatibility between EM-A motors and FR-E800 inverters

Model	Applicable motor capacity (kW)									
	0.1	0.2	0.4	0.75	1.5	2.2	3.7	5.5	7.5	
Three-phase 200 V FR-E820	○	○	○	○	○	○	○	○	○	
Three-phase 400 V FR-E840	-	-	×	×	×	○	○	○	×	
Single-phase 200 V FR-E820S	○	○	○	○	○	○	-	-	-	
Single-phase 100 V FR-E810W	○	○	○	○	-	-	-	-	-	

○: Compatible, ×: Not compatible (to be compatible), -: Not applicable

◆ Outline Dimensions

●EM-AMF 0.1kW

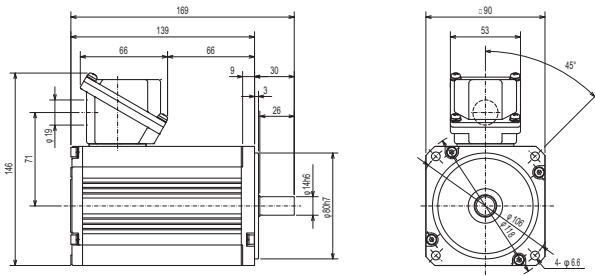

●EM-AMF 0.2kW

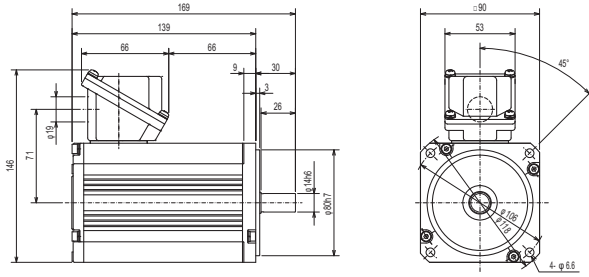

●EM-AMF 0.4kW

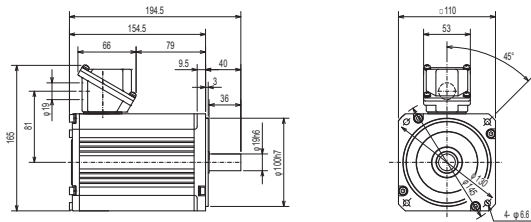

●EM-AMF 0.75kW

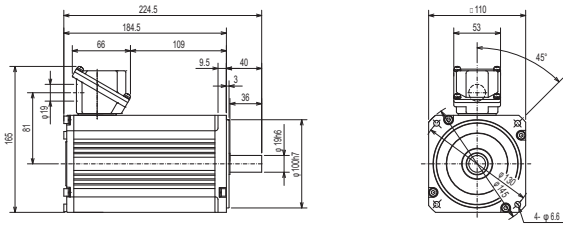

●EM-AMF 1.5kW

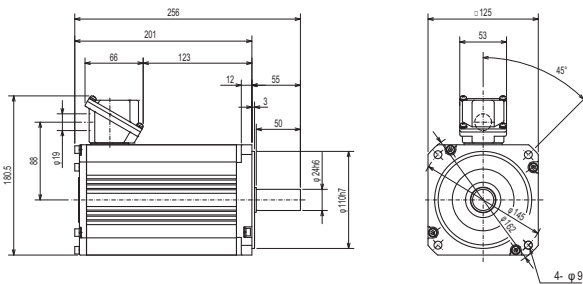

●EM-AMF 2.2kW

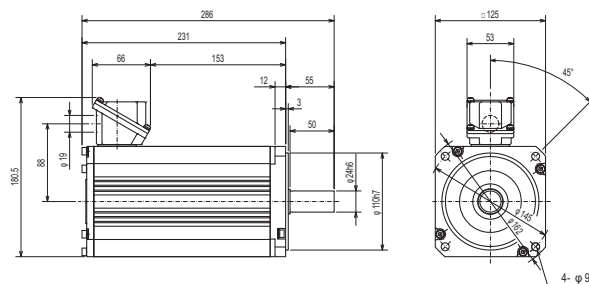

●EM-AMF 3.7kW

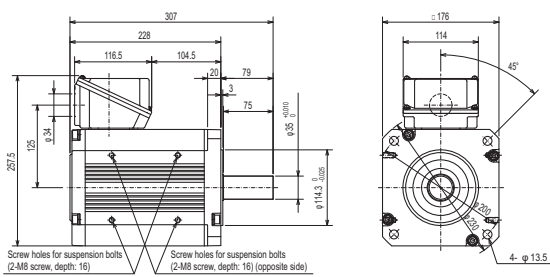

●EM-AMF 5.5kW

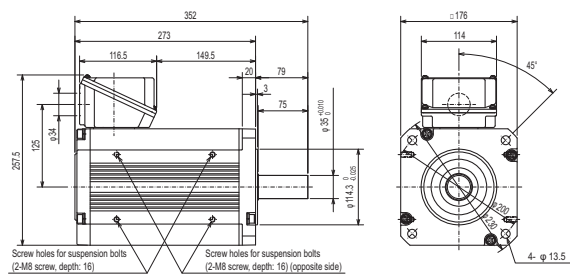

●EM-AMF 7.5kW

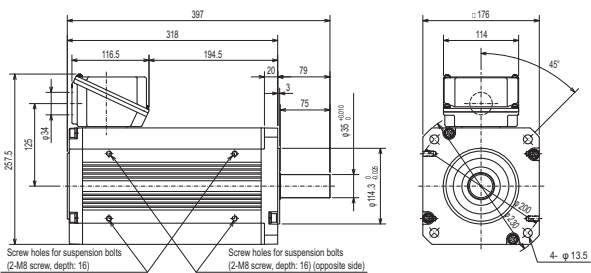

(Unit: mm)

●EM-AMFB 0.1kW

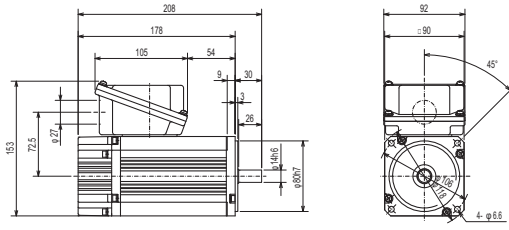

●EM-AMFB 0.2kW

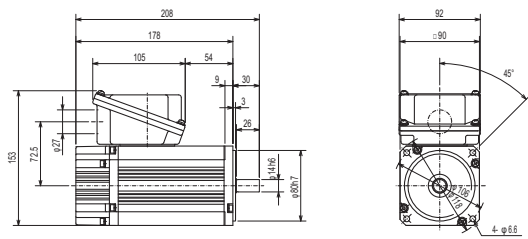

●EM-AMFB 0.4kW

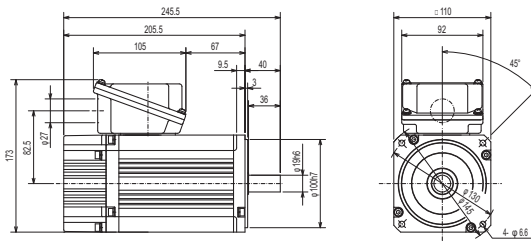

●EM-AMFB 0.75kW

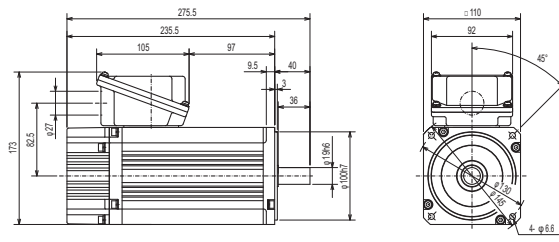

●EM-AMFB 1.5kW

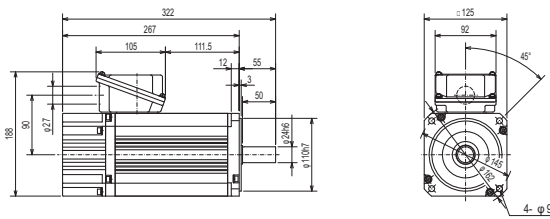

●EM-AMFB 2.2kW

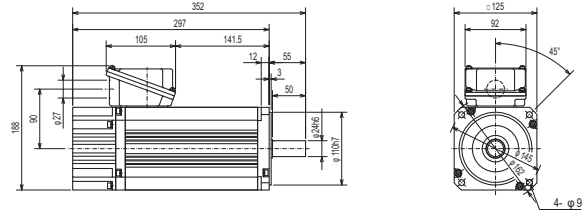

●EM-AMFB 3.7kW

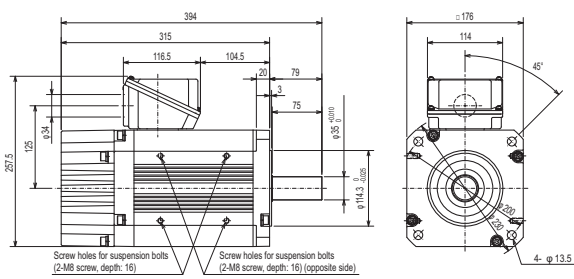

●EM-AMFB 5.5kW

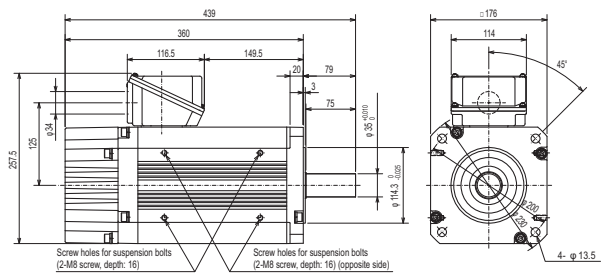

●EM-AMFB 7.5kW

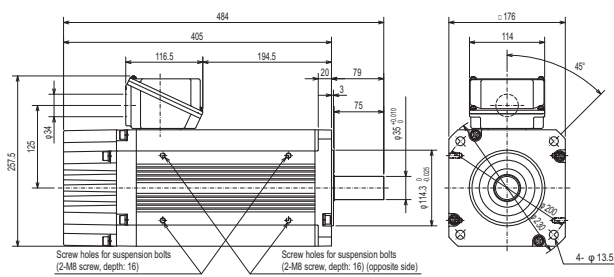

(Unit: mm)

◆ Specification comparison between PM sensorless vector control and induction motor control

Item	PM sensorless vector control	Induction motor control
Applicable motor	IPM motor, SPM motor *1	Induction motor *1
Starting torque	MM-GKR, EM-A: 200% Motor other than the above: 50%	200% (FR-E820-0175(3.7K) or lower, FR-E840-0095(3.7K) or lower, FR-E860-0061(3.7K) or lower, FRE820S-0110(2.2K) or lower, FR-E810W-0050(0.75K) or lower) and 150% (FR-E820-0240(5.5K) or higher, FR-E840-0120(5.5K) or higher, and FR-E860-0090(5.5K) or higher) under Real sensorless vector control or Vector control*2
Startup delay	Startup delay of about 0.1 s for magnetic pole position detection.	No startup delay (when online auto tuning is not performed at startup).
Driving by the commercial power supply	Cannot be driven by the commercial power supply.	Can be driven by the commercial power supply. (Other than vector control dedicated motor.)
Operation during coasting	While the motor is coasting, potential is generated across motor terminals.	While the motor is coasting, potential is not generated across motor terminals.
Torque control	Not available	Real sensorless vector control or Vector control*2

*1 For the motor capacity, the rated motor current should be equal to or less than the rated inverter current. If a motor with substantially low rated current compared with the inverter rated current is used, speed and torque accuracies may deteriorate due to torque ripples, etc. Set the rated motor current to about 40% or higher of the inverter rated current.

*2 Available when a Vector control compatible option is installed.

 **NOTE**

- Before wiring, make sure that the motor is stopped. Otherwise an electric shock may occur.
- Never connect an IPM motor to the commercial power supply.
- No slippage occurs with an IPM motor because of its characteristic. If an IPM motor, which took over an induction motor, is driven at the same speed as for the induction motor, the running speed of the IPM motor becomes faster by the amount of the induction motor's slippage. Adjust the speed command to run the IPM motor at the same speed as the induction motor, as required.

● Countermeasures against deterioration of the 400 V class motor insulation

When driving a 400 V class motor by the inverter, surge voltage, which is attributed to the length and thickness of wire, may occur at the motor terminals, causing the motor insulation to deteriorate. When the 400 V class motor is driven by the inverter, consider the following countermeasures:

◆ With induction motor

It is recommended to take one of the following countermeasures:

◆ Rectifying the motor insulation and limiting the PWM carrier frequency according to the wiring length

For the 400 V class motor, use an insulation-enhanced motor.

Specifically,

- Order a "400 V class inverter-driven insulation-enhanced motor".
- For the dedicated motor such as the constant-torque motor and low-vibration motor, use an "inverter-driven dedicated motor".
- Set **Pr.72 PWM frequency selection** as indicated below according to the wiring length.

Wiring length 50 m or shorter	Wiring length 50 m to 100 m	Wiring length Longer than 100 m
14.5 kHz or lower	8 kHz or lower	2 kHz lower

◆ Suppressing the surge voltage on the inverter side

- Connect a surge voltage suppression filter (FR-ASF-H/FR-BMF-H) at the output side of the inverter.

◆ With PM motor

Use the wiring length of 100 m or shorter when connecting a PM motor.

Use one PM motor for one inverter. Multiple PM motors cannot be connected to an inverter.

When the wiring length exceeds 50 m for a 400 V class motor driven by an inverter under PM sensorless vector control, set "9" (6 kHz) or less in **Pr.72 PWM frequency selection**.



- A surge voltage suppression filter (FR-ASF-H/FR-BMF-H) can be used under V/F control and Advanced magnetic flux vector control.

● Application to special motors

◆ Motors with brake

Use the motor with brake having independent power supply for the brake, connect the brake power supply to the inverter primary side power and make the inverter output off using the output stop terminal (MRS) when the brake is applied (motor stop). Rattle may be heard according to the type of the brake in the low speed region but it is not a fault.

◆ Pole changing motor

As this motor differs in rated current from the standard motor, confirm the maximum current of the motor and select the inverter. Be sure to change the number of poles after the motor has stopped. If the number of poles is changed during rotation, the regenerative overvoltage protection circuit may be activated to cause an inverter alarm, coasting the motor to a stop.

◆ Submersible motor

Since the motor rated current is larger than that of the standard motor, make selection of the inverter capacity carefully. In addition, the wiring distance between the motor and inverter may become longer, refer to **page 122** to perform wiring with a cable thick enough. Leakage current may flow more than the land motor, take care when selecting the earth leakage current breaker.

◆ Explosion-proof motor

To drive an explosion-proof type motor, an explosion-proof test of the motor and inverter together is necessary. The test is also necessary when driving an existing explosion-proof motor.

The inverter is a non-explosion proof structure, install it in a safety location.

◆ Geared motor

The continuous operating rotation range of this motor changes depending on the lubrication system and maker. Especially in the case of oil lubrication, continuous operation in the low-speed range only can cause gear seizure. For fast operation at higher than 60 Hz, please consult the motor maker.

◆ Synchronous motor other than PM motor

This motor is not suitable for applications of large load variation or impact, where out-of-sync is likely to occur. Please contact your sales representative when using this motor because its starting current and rated current are greater than those of the standard motor and will not rotate stably at low speed.

◆ Single-phase motor

The Single-phase motor is not suitable for variable operation by the inverter.

For the capacitor starting system, the capacitor may be damaged due to harmonic current flowing to the capacitor. For the split-phase starting system and repulsion starting system, not only output torque is not generated at low speed but it will result in starting coil burnout due to failure of centrifugal force switch inside. Replace with a three-phase motor for use.

Compatibility

● Major differences from the FR-E700 series

Item	FR-E800	FR-E700	
Outline dimensions	Compatible The product width and height are different between the FR-E800 and FR-E700 inverters for some capacity models. • 3-phase 200 V-3.7K: Changed from 170 mm to 140 mm • 3-phase 400 V to 0.4K to 1.5K: Changed from 140 mm to 108 mm • Single-phase 200 V-2.2K: Changed from 150 mm to 128 mm		
Installation dimensions	Compatible The product width and height are different between the FR-E800 and FR-E700 inverters for some capacity models. (Installation interchange attachments are available.) • 3-phase 200 V-3.7K: Changed from 158 mm to 128 mm • 3-phase 400 V-0.4K to 1.5K: Changed from 128 mm to 96 mm • Single-phase 200 V-2.2K: Changed from 138 mm to 118 mm		
Multiple rating	Two ratings (LD/ND) ND rating only for the single-phase 200/100 V class.	N/A (ND rating only)	
Permissible load	ND rating	150% 60 s, 200% 3 s at surrounding air temperature of 50°C	
	LD rating	120% 60 s, 150% 3 s at surrounding air temperature of 50°C N/A	
Built-in brake transistor	200 V class: 0.4K to 22K 400 V class: 0.4K to 22K 575 V class: 0.75K to 7.5K 100 V class: 0.4K, 0.75K	200 V class: 0.4K to 15K 400 V class: 0.4K to 15K 100 V class: 0.4K, 0.75K	
Control method	—	Soft-PWM control / High carrier frequency PWM	
	V/F control	Available	
	Advanced magnetic flux vector control	Available	
	General-purpose magnetic flux vector control	Not available	Available
	Real sensorless vector control	Available	Not available
	Vector control	Available (The FR-A8AP E kit plug-in option is required.)	Not available
Control mode	PM sensorless vector control	Available	Not available
	Speed control	Available	
	Torque control	Available	Not available
	Position control	Available	Not available
Output frequency	0.2 to 590 Hz (under V/F control) 0.2 to 400 Hz (under other than V/F control)	0.2 to 400 Hz	
Frequency setting resolution	Terminal 2	0.015 Hz / 0 to 60 Hz (0 to 10 V / 12 bits) 0.03 Hz / 0 to 60 Hz (0 to 5 V / 11 bits) 0.03 Hz / 0 to 60 Hz (0 to 20 mA / 11 bits)	0.06 Hz / 0 to 60 Hz (0 to 10 V / 10 bits) 0.12 Hz / 0 to 60 Hz (0 to 5 V / 9 bits)
	Terminal 4	0.015 Hz / 0 to 60 Hz (0 to 10 V / 12 bits) 0.03 Hz / 0 to 60 Hz (0 to 5 V / 11 bits) 0.03 Hz / 0 to 60 Hz (0 to 20 mA / 11 bits)	0.06 Hz / 60 Hz (0 to 10 V / 10 bits) 0.12 Hz / 60 Hz (0 to 5 V / 9 bits) 0.06 Hz / 60 Hz (0 to 20 mA / 10 bits)
Input signal	Terminal function	Major additional functions • Signals added for additional control methods/modes (e.g. MC signal for control mode switching) • Signals added for the trace function (e.g. Trace trigger input (TRG) signal) • Signals added for the PLC function (Sequence start (SQ) signal)	-
	Safety stop signal	FR-E800/FR-E800-E: Safety stop input (S1) Safety stop input (S2) Safety stop input common (PC) FR-E800-SCE: SX1, SX2, SY1, SY2, SC1, SC2 (for functional safety)	Safety stop function model only. Safety stop input (S1) Safety stop input (S2) Safety stop input common (PC)
Operational functions	Major additional functions Traverse, multi-rating, PLC function, pre-excitation, torque limit, trace function, load fault detection, Ethernet communication (incl. CC-Link IE TSN, EtherNet/IP), and others	-	
Output signal	Terminal function	Major additional functions • Signals added for additional control methods/modes (e.g. Home position return completed (ZP) signal) • Signals added for the load fault detection function (e.g. Upper limit warning detection (LUP) signal) • Virtual output terminals for communication (NET Y1 to Y4)	-
	Specification of terminal FM	1440 pulses/s at full scale	
	Specification of terminal AM	-10 to +10 V / 12 bits	AM: 0 to +10 V (Provided only for inverters other than Japanese specification)
	Output signal (for terminal FM / terminal AM)	Major additional functions • Signals added for additional control methods/modes (e.g. position command, torque monitor) • PID measured value 2	-
Output signal (for communication)	Major additional functions • Signals added for BACnet communication (e.g. signal for BACnet reception status) • Communication station number (PU port, CC-Link)	-	

Item		FR-E800	FR-E700
Output signal	Safety stop function	FR-E800/FR-E800-E: • Safety monitor output (SO) • Safety stop input/output common (SOC) • The following signals can be assigned to output terminals. SAFE signal (used to monitor safety stop status) SAFE2 signal (output when a fault is detected) FR-E800-SCE: • Terminals are not used. (Safety communication supported) • The following signals can be assigned to virtual output terminals for communication. SAFE signal (used to monitor safety stop status) SAFE2 signal (output when a fault is detected)	The following signals can be assigned to output terminals. SAFE signal (used to monitor safety stop status) SAFE2 signal (output when a fault is detected) (Safety stop function model only.)
Protective/ warning output	Protective function	Major additional functions Upper limit fault detection (E.LUP), excessive position fault (E.OD), and others	-
	Warning function	Major additional functions Stroke limit warning (LP), Duplicate IP address (DIP), IP address fault (IP), Incorrect parameter setting (SE), and others	-
Operation panel	Standard	Operation panel equipped as standard (not removable).	Four-digit display using a 7-segment LED is employed.
	Optional	Enclosure surface operation panel (FR-PA07) Parameter unit (FR-PU07(BB)) LCD operation panel (FR-LU08)	Enclosure surface operation panel (FR-PA07) Parameter unit (FR-PU07(BB))
Main circuit terminals		R, S, T, U, V, W, P, PR, N, P1, earth (ground) (screw terminal type)	
Control circuit terminal	Shape of terminal block	Spring clamp type	Standard control circuit terminal model: Screw type Safety stop function model: Spring clamp type
	Contact input	FR-E800: 7 terminals FR-E800-E: 2 terminals FR-E800-SCE: 0 terminals	Standard control circuit terminal model: 7 terminals Safety stop function model: 6 terminals
	Analog input	FR-E800 / FR-E800-E: 2 terminals FR-E800-SCE: 0 terminals	2 terminals
	Relay output	FR-E800 / FR-E800-E / FR-E800-SCE: 1 terminal	1 terminal
	Open collector output.	FR-E800: 2 terminals FR-E800-E: 0 terminals FR-E800-SCE: 0 terminals	2 terminals
	Pulse output	1 terminal (FM type only)	1 terminal
	Analog output	1 terminal (AM type only)	N/A
	Safety I/O signal	FR-E800/FR-E800-E: S1, S2, SIC, SO, SOC FR-E800-SCE: SX1, SX2, SY1, SY2, SC1, SC2	S1, S2, PC (Safety stop function model only.)
Communication	Ethernet	FR-E800: N/A FR-E800-E/FR-E800-SCE: Available, two ports CC-Link IE TSN, CC-Link IE Field Network Basic, EtherNet/IP, PROFINET, MODBUS/TCP, BACnet/IP, EtherCAT	FR-E700-NE: Available, one port CC-Link IE Field Network Basic, MODBUS/TCP Other than the above: N/A
	Safety communication	FR-E800/FR-E800-E: N/A FR-E800-SCE only: CC-Link IE TSN Safety communication function, CIPsafety, PROFIsafe	N/A
	RS-485	FR-E800: 1 port, Mitsubishi inverter protocol, MODBUS RTU, BACnet MS/TP FR-E800-E/FR-E800-SCE: N/A	
	USB	Available, mini B connector, USB bus power available (Maximum SCCR: 500 mA)	Available, mini B connector, USB bus power unavailable
Plug-in option		FR-A8AX E kit, FR-A8AY E kit, FR-A8AR E kit, FR-A8NC E kit, FR-A8NP E kit, FR-A8ND E kit, FR-A8AP E kit, FR-E8DS E kit The option is connected to the inverter for earthing (grounding) through the earth plate of the inverter.	FR-A7AX E kit, FR-A7AY E kit, FR-A7AR E kit, FR-A7NC E kit, FR-A7NP E kit, FR-A7ND E kit, FR-E7DS
Surrounding air temperature		100/200/400 V class: -20°C to +60°C (Derate the rated current when using the inverter in a temperature exceeding 50°C.) 575 V class: -10°C to +60°C (Derate the rated current when using the inverter in a temperature exceeding 50°C.)	-10°C to +50°C
Storage temperature		-40°C to +70°C	-20°C to +65°C

◆ Installation precautions

- Removal procedure of the front cover is different. (Refer to the Instruction Manual (Connection).)
- Plug-in options of the FR-A700 series are not compatible.

◆ Wiring precautions

- When the FR-E700 standard control circuit terminal model is replaced, the terminal block type is changed from the screw type to the spring clamp type. Use of blade terminals is recommended.
When our authorized crimp terminals are used for the FR-E700 inverters, they cannot be used for the FR-E800 series inverters since they are not compatible with the spring clamp terminal block. (Some crimp terminals may not be used for the FR-E800 series inverters due to differences in size.) For details, refer to the Information for Replacement of FR-E700 Series with FR-E800 Series (BCN-C21002-214).
- To use the PU connector, note that wiring methods are different. (Refer to the Instruction Manual (Connection).)

● Comparison with the FR-E700 series in functions

Parameter/function	Differences with the FR-E700				Remarks
	Addition	Modification	Deletion	Related parameter	
Base frequency or other functions related to output frequency		✓		Pr.3 and others	Maximum setting was changed from 400 Hz to 590 Hz. Max. 400 Hz when the control method is not V/F control.
MRS input selection		✓		Pr.17	Addition of normally closed (NC contact) input specification for terminal X10
Stall prevention operation level and related functions		✓		Pr.22, Pr.150, Pr.165	Multiple ratings LD: 120% ND: 150%
Operation panel main monitor selection, TM terminal function selection, and related functions		✓		Pr.52, Pr.54, and others	Addition of monitor items (e.g. running speed)
Frequency / rotation speed Unit switchover	✓			Pr.53	
Restart coasting time and others		✓		Pr.57, Pr.165	Change of the setting range
Remote function selection		✓		Pr.59	Remote setting enabled for deceleration to the frequency to the set frequency or lower
Retry waiting time		✓		Pr.68	• Change of the retry waiting time • Change of the operation to be performed when a fault that does not trigger a retry occurs during retry waiting time
Special regenerative brake duty		✓		Pr.70	Change of the setting range for the brake duty
Applied motor		✓		Pr.71	Addition of motors: • Mitsubishi Electric high-performance energy-saving motor SF-PR series • Mitsubishi Electric geared motor GM series • Mitsubishi Electric Vector control dedicated motor SF-V5RU series • Mitsubishi Electric high-performance energy-saving motor with encoder SF-PR-SC series • Mitsubishi Electric PM motor EM-A series
Motor capacity, number of motor poles, and the like		✓		Pr.80, Pr.81, and others	Addition of 11 to 30 kW motors. 12 motor poles are supported.
Online auto tuning selection	✓			Pr.95	
Built-in potentiometer switching			✓	Pr.146	
Output current detection operation selection	✓			Pr.166, Pr.167	
I/O terminal function selection and related functions		✓		Pr.178 to Pr.192	Addition of input/output signals
NET output selection	✓			Pr.193 to Pr.196	
Display corrosion level (Control circuit board Corrosion-Attack-Level Alert System)	✓			Pr.198	
PWM frequency automatic switchover	✓			Pr.260	
Brake opening current		✓		Pr.279	The setting range is extended to 400%.
Speed deviation excess detection frequency	✓			Pr.285	
Inverter output terminal filter	✓			Pr.289	The terminal response can be adjusted.
Monitor negative output selection	✓			Pr.290	
Overspeed detection level	✓			Pr.374	
Initial communication delay time, heartbeat settings			✓	Pr.387 to Pr.389, Pr.391, Pr.392	
PLC function	✓			Pr.414, Pr.415, Pr.498, Pr.675, Pr.1150 to Pr.1199	
Extension output terminal filter	✓			Pr.418	
Gateway address	✓			Pr.442 to Pr.445	
Digital torque command	✓			Pr.447, Pr.448	
Second motor control	✓			Pr.450, Pr.451, Pr.453 to Pr.462, Pr.463 and others	
Speed setting reference	✓			Pr.505	
Display estimated main circuit capacitor residual life	✓			Pr.506	
Display ABC relay contact life	✓			Pr.507	
Display power cycle life	✓			Pr.509	
PID signal operation selection	✓			Pr.553, Pr.554	
Second frequency search gain	✓			Pr.560	
Multiple rating setting	✓			Pr.570	
PID output suspension function	✓			Pr.575 to Pr.577	
Traverse function	✓			Pr.592 to Pr.597	
PID set point and related settings	✓			Pr.609, Pr.610	
Inverter output fault detection enable/disable selection	✓			Pr.631	
Brake opening current selection	✓			Pr.639	
Brake operation frequency selection	✓			Pr.640	
Speed smoothing cutoff frequency	✓			Pr.654	

Parameter/function	Differences with the FR-E700				Remarks
	Addition	Modification	Deletion	Related parameter	
SF-PR slip amount adjustment	✓			Pr.673, Pr.674	
Input terminal filter	✓			Pr.699	The terminal response can be adjusted.
Device instance	✓			Pr.728, Pr.729	
Second motor constant and related settings	✓			Pr.737 to Pr.746	
PID unit selection	✓			Pr.759	
Operation panel monitor item selection	✓			Pr.774 to Pr.776	
Operation frequency during communication error	✓			Pr.779	
Acceleration time in low-speed range deceleration time in low-speed range	✓			Pr.791, Pr.792	
Control mode selection	✓	✓	✓	Pr.800, Pr.702 to Pr.712, Pr.717, Pr.720, Pr.721, Pr.724, Pr.725, and others	<ul style="list-style-type: none"> • Addition of Real sensorless vector control speed control, torque control • Addition of Vector control speed control, torque control, position control • Addition of PM sensorless vector control speed control, position control • Deletion of General-purpose magnetic flux vector control • Setting value for V/F control changed to 40
Real sensorless vector control, Vector control	✓			Pr.801, Pr.803 to Pr.817, Pr.820, Pr.821, Pr.823 to Pr.825, Pr.828, Pr.830, Pr.831, Pr.833 to Pr.835, Pr.840 to Pr.848, Pr.858, Pr.874, Pr.877 to Pr.881 and others	
Analog input offset adjustment	✓			Pr.849	
Low speed detection	✓			Pr.865	
Terminal 4 function	✓			Pr.858, Pr.932 to Pr.933	
AM output filter	✓			Pr.867	
Speed detection hysteresis	✓			Pr.870	
OLT level setting	✓			Pr.874	
Energy saving monitoring	✓			Pr.891 to Pr.899	
PID display	✓			Pr.934 to Pr.935	
Display safety fault code	✓			Pr.986	
Operation panel setting dial push monitor selection	✓			Pr.992	
Fault initiation	✓			Pr.997	
PM parameter initialization	✓			Pr.998	
Automatic parameter setting	✓			Pr.999	
Clock function	✓			Pr.1006 to Pr.1008	
Trace function	✓			Pr.1020 to Pr.1047	
Monitor filter	✓			Pr.1106 to Pr.1108	Filter for monitoring of torque, running speed, and excitation current
Inverter-to-inverter link function	✓			Pr.1124, Pr.1125	
Inverter identification enable/disable selection	✓			Pr.1399	
Ethernet communication function (CC-Link IE TSN and others)	✓			Pr.1424 to Pr.1457	FR-E700-NE supports CC-Link IE Field Network Basic, MODBUS/TCP, MELSOFT / FA product connection, and SLMP.
Load characteristics fault detection	✓			Pr.1480 to Pr.1492	
Functional safety (SIL3)	✓			Pr.S001 to Pr.S027, Pr.S051, Pr.S055, Pr.S061, Pr.S066, Pr.S070, Pr.S071	
Encoder feedback control	✓			Pr.285, Pr.359, Pr.367 to Pr.369, Pr.376	
Orientation control	✓			Pr.350 to Pr.359, Pr.361 to Pr.366, Pr.369, Pr.393, Pr.396 to Pr.399	
6-point frequency jump	✓			Pr.552	
Increased magnetic excitation deceleration	✓			Pr.660 to Pr.662	
Advanced optimum excitation control	✓			Pr.60, Pr.9, Pr.71, Pr.80, Pr.81, Pr.83, Pr.84, Pr.800	
CC-Link IE TSN Safety communication function	✓			Pr.S030 to Pr.S032	
CIPsafety	✓			Pr.S135 to Pr.S149	
PROFIsafe	✓			Pr.S089	
Free thermal (electronic thermal O/L relay function)	✓			Pr.600 to Pr.604, Pr.692 to Pr.696	

● Major differences among the standard model [E800], Ethernet model [E800-E], and safety communication model [E800-SCE].

Notation

[E800-1]: FM type, [E800-4]: AM (50 Hz) type, [E800-5]: AM (60 Hz) type, [E800-EPA]: Protocol group A, [E800-EPB]: Protocol group B, [E800-EPC]: Protocol group C, [E800-SCEPA]: Protocol group A, [E800-SCEPB]: Protocol group B

Item		Standard model [E800]			Ethernet model [E800-E]			Safety communication model [E800-SCE]	
		[E800-1]	[E800-4]	[E800-5]	[E800-EPA]	[E800-EPB]	[E800-EPC]	[E800-SCEPA]	[E800-SCEPB]
Input terminal	Contact	7	7	7	2	2	2	-	-
	Analog	2	2	2	1	1	1	1	1
Output terminal	Open collector	2	2	2	-	-	-	-	-
	Relay	1	1	1	1	1	1	1	1
Safety input/output signal	Contact input	2	2	2	2	2	2	2	2
	Open collector output	1	1	1	1	1	1	1	1
Connector	PU	1	1	1	-	-	-	-	-
	USB (mini B)	1	1	1	1	1	1	1	1
	Ethernet	-	-	-	2	2	2	2	2
Operation panel	Setting dial	●	●	●	-	-	-	-	-
	Up/Down key	-	-	-	●	●	●	●	●
Communication	CC-Link IE TSN (100Mbps)	-	-	-	●	●	-	●	●
	CC-Link IE Field Network Basic	-	-	-	●	●	-	●	●
	MODBUS /TCP	-	-	-	●	●	-	●	●
	EtherNet/IP	-	-	-	●	-	-	●	-
	BACnet/IP	-	-	-	●	-	-	●	-
	PROFINET	-	-	-	-	●	-	-	●
	EtherCAT	-	-	-	-	-	●	-	-
	CC-Link IE TSN Safety communication function	-	-	-	-	-	-	●	-
	CIP Safety	-	-	-	-	-	-	●	-
	PROFIsafe	-	-	-	-	-	-	-	●
	Mitsubishi inverter protocol	●	●	●	-	-	-	-	-
	MODBUS RTU	●	●	●	-	-	-	-	-
	BACnet MS/TP	●	●	●	-	-	-	-	-
	CC-Link (FR-A8NC Ekit)	●	●	●	●	●	●	●	●
DeviceNet (FR-A8ND Ekit)	●	●	●	●	●	●	●	●	
PROFIBUS-DP (FR-A8NP Ekit)	●	●	●	●	●	●	●	●	
Control logic	Input signal (Initial setting)	Sink	Source	Sink	Sink	Sink/Source*1	Sink/Source*1	Sink	Sink/Source*1
	Safety stop signal	Source (fixed)	Source (fixed)	Source (fixed)	Source (fixed)	Source (fixed)	Source (fixed)	Source (fixed)	Source (fixed)
Monitor output terminal for indicator		FM	AM	AM	-	-	-	-	-
Plug-in option	FR-A8AP Ekit	●	●	●	●	●	●	●	●
	FR-A8AX Ekit	●	●	●	●	●	●	●	●
	FR-A8AY Ekit	●	●	●	●	●	●	●	●
	FR-A8AR Ekit	●	●	●	●	●	●	●	●
	FR-A8NC Ekit	●	●	●	●	●	●	●	●
	FR-A8ND Ekit	●	●	●	●	●	●	●	●
	FR-A8NP Ekit	●	●	●	●	●	●	●	●
FR-E8DS Ekit*2*3	●	●	●	●	●	●	●	●	

12
Compatibility

Item	Standard model [E800]			Ethernet model [E800-E]			Safety communication model [E800-SCE]	
	[E800-1]	[E800-4]	[E800-5]	[E800- EPA]	[E800- EPB]	[E800- EPC]	[E800- SCEPA]	[E800- SCEPB]
Stand-alone option	FR-LU08 (-01)	●	●	●	-	-	-	-
	FR-PU07	●	●	●	-	-	-	-
	FR-PU07BB (-L)	●	●	●	-	-	-	-
	FR-PA07	●	●	●	-	-	-	-
	FR-CB20[]	●	●	●	-	-	-	-
	FR-V7CBL[]	●	●	●	●	●	●	●
	USB cable (MR-J3USBCBL3M Cable length: 3m)	●	●	●	●	●	●	●
	FR-E7AT 01/02/03	●	●	●	●	●	●	●
	FR-E8AT03	●	●	●	●	●	●	●
	FR-E8AT04	●	●	●	●	●	●	●
	FR-UDA 01 to 03	●	●	●	●	●	●	●
	FR-E8CN 01 to 06	●	●	●	●	●	●	●
	FR-E8CV 01 to 04	○	○	○	○	○	○	○
	FR-HAL	●	●	●	●	●	●	●
	FR-HEL	●	●	●	●	●	●	●
	SF, FR-E5NF, FR-S5NFSA	●	●	●	●	●	●	●
	FR-A5AT03, FR-AAT02, FR-E5T(-02)	●	●	●	●	●	●	●
	FR-BIF(H)	●	●	●	●	●	●	●
	FR-BFS01, FR-BLF	●	●	●	●	●	●	●
	FR-BFP2	●	●	●	●	●	●	●
	Brake resistor (MRS type, MYS type)	●	●	●	●	●	●	●
	FR-ABR	●	●	●	●	●	●	●
	FR-BU2, FR-BR, Discharging resistor (GZG, GRZG type)	●	●	●	●	●	●	●
	FR-XC (Common bus regeneration mode), FR-XCL	●	●	●	●	●	●	●
	FR-XC (Harmonic suppression mode), FR-XCB	●	●	●	●	●	●	●
	FR-XC (Power regeneration mode 1/2), FR-XCG	●	●	●	●	●	●	●
FR-HC2	●	●	●	●	●	●	●	
FR-ASF	●	●	●	●	●	●	●	
FR-BMF	●	●	●	●	●	●	●	
Others	QVAH-10	●	●	●	●	●	●	●
	YVGC-500WNS	●	●	●	●	●	●	●
	YM-206NRI 1mA	●	●	●	-	-	-	-
	RV24YN 10kΩ	●	●	●	●	●	●	●
	FR Configurator2 (Inverter setup software) SW1DND-FRC2	●	●	●	●	●	●	●
	FR Configurator Mobile (Mobile App for Inverters)	-	-	-	●	●	●	●

●: available, -: N/A, ○: To be supported soon

- *1 The initial status of the control logic differs depending on the inverter model.
Sink logic for the models indicated with the rated capacity (kW)
Source logic for the models indicated with the rated current (A).
- *2 During the 24 V external power supply operation, the inverter operation is disabled.
- *3 Up to four inverters can be connected in series.

◆ Related manuals

The manuals related to the FR-E800 inverter are as follows. The download of the latest manuals is free at the Mitsubishi Electric FA Global Website.

Manual name	Description	Standard model	Ethernet model	Safety communication model	Manual number
FR-E800 INVERTER SAFETY GUIDELINE	Basic wiring and operation (Instruction Manual enclosed with the inverter)	• (100V/200V/ 400V)			IB-0600857ENG
FR-E800-E INVERTER SAFETY GUIDELINE			• (100V/200V/ 400V)		IB-0600860ENG
FR-E800-SCE INVERTER SAFETY GUIDELINE				• (100V/200V/ 400V)	IB-0600921ENG
FR-E860 INVERTER SAFETY GUIDELINE		• (575V)			IB-0600862ENG
FR-E860-E INVERTER SAFETY GUIDELINE			• (575V)		IB-0600863ENG
FR-E860-SCE INVERTER SAFETY GUIDELINE				• (575V)	IB-0600924ENG
FR-E800 INSTRUCTION MANUAL (CONNECTION)	Installation and wiring, precautions for use of the inverter	• (100V/200V/ 400V)	• (100V/200V/ 400V)	• (100V/200V/ 400V)	IB-0600865ENG
FR-E860 INSTRUCTION MANUAL (CONNECTION)		• (575V)	• (575V)	• (575V)	IB-0600906ENG
FR-E800 INSTRUCTION MANUAL (FUNCTION)	Basic operation, description of functions (parameters)	•	•	•	IB-0600868ENG
FR-E800 INSTRUCTION MANUAL (COMMUNICATION)	Wiring and settings for communication	•	•	•	IB-0600871ENG
FR-E800 INSTRUCTION MANUAL (MAINTENANCE)	Protective functions, precautions for maintenance and inspection	•	•	•	IB-0600874ENG
FR-E800(-E) INSTRUCTION MANUAL (FUNCTIONAL SAFETY)	Details of functional safety	•	•		BCN-A23488-000
FR-E800-SCE INSTRUCTION MANUAL (FUNCTIONAL SAFETY)				•	BCN-A23488-004
PLC Function Programming Manual	Use of the PLC function	•	•	•	IB-0600492ENG
FR Configurator2 INSTRUCTION MANUAL	Details of the inverter setup software	•	•	•	IB-0600516ENG

Warranty

When using this product, make sure to understand the warranty described below.

1. Warranty period and coverage

We will repair any failure or defect (hereinafter referred to as "failure") in our FA equipment (hereinafter referred to as the "Product") arisen during warranty period at no charge due to causes for which we are responsible through the distributor from which you purchased the Product or our service provider. However, we will charge the actual cost of dispatching our engineer for an on-site repair work on request by customer in Japan or overseas countries. We are not responsible for any on-site readjustment and/or trial run that may be required after a defective unit are repaired or replaced.

[Term]

The term of warranty for Product is twelve months after your purchase or delivery of the Product to a place designated by you or eighteen months from the date of manufacture whichever comes first ("Warranty Period"). Warranty period for repaired Product cannot exceed beyond the original warranty period before any repair work.

[Limitations]

- (1) You are requested to conduct an initial failure diagnosis by yourself, as a general rule. It can also be carried out by us or our service company upon your request and the actual cost will be charged. However, it will not be charged if we are responsible for the cause of the failure.
- (2) This limited warranty applies only when the condition, method, environment, etc. of use are in compliance with the terms and conditions and instructions that are set forth in the instruction manual and user manual for the Product and the caution label affixed to the Product.
- (3) Even during the term of warranty, the repair cost will be charged on you in the following cases;
 - 1) a failure caused by your improper storing or handling, carelessness or negligence, etc., and a failure caused by your hardware or software problem
 - 2) a failure caused by any alteration, etc. to the Product made on your side without our approval
 - 3) a failure which may be regarded as avoidable, if your equipment in which the Product is incorporated is equipped with a safety device required by applicable laws and has any function or structure considered to be indispensable according to a common sense in the industry
 - 4) a failure which may be regarded as avoidable if consumable parts designated in the instruction manual, etc. are duly maintained and replaced
 - 5) any replacement of consumable parts (condenser, cooling fan, etc.)
 - 6) a failure caused by external factors such as inevitable accidents, including without limitation fire and abnormal fluctuation of voltage, and acts of God, including without limitation earthquake, lightning and natural disasters
 - 7) a failure caused by using the emergency drive function
 - 8) a failure generated by an unforeseeable cause with a scientific technology that was not available at the time of the shipment of the Product from our company
 - 9) any other failures which we are not responsible for or which you acknowledge we are not responsible for

2. Term of warranty after the stop of production

- (1) We may accept the repair at charge for another seven (7) years after the production of the product is discontinued. The announcement of the stop of production for each model can be seen in our Sales and Service, etc.
- (2) Please note that the Product (including its spare parts) cannot be ordered after its stop of production.

3. Service in overseas

Our regional FA Center in overseas countries will accept the repair work of the Product; however, the terms and conditions of the repair work may differ depending on each FA Center. Please ask your local FA center for details.

4. Exclusion of loss in opportunity and secondary loss from warranty liability

Regardless of the gratis warranty term, Mitsubishi shall not be liable for compensation to:

- (1) Damages caused by any cause found not to be the responsibility of Mitsubishi.
- (2) Loss in opportunity, lost profits incurred to the user by Failures of Mitsubishi products.
- (3) Special damages and secondary damages whether foreseeable or not, compensation for accidents, and compensation for damages to products other than Mitsubishi products.
- (4) Replacement by the user, maintenance of on-site equipment, start-up test run and other tasks.

5. Change of Product specifications

Specifications listed in our catalogs, manuals or technical documents may be changed without notice.

6. Application and use of the Product

- (1) For the use of our product, its applications should be those that may not result in a serious damage even if any failure or malfunction occurs in product, and a backup or fail-safe function should operate on an external system to product when any failure or malfunction occurs.
- (2) Our product is designed and manufactured as a general purpose product for use at general industries. Therefore, applications substantially influential to the public interest for such as atomic power plants and other power plants of electric power companies, and also which require a special quality assurance system, including applications for railway companies and government or public offices are not recommended, and we assume no responsibility for any failure caused by these applications when used. In addition, applications which may be substantially influential to human lives or properties for such as airlines, medical treatments, railway service, incineration and fuel systems, man-operated material handling equipment, entertainment machines, safety machines, etc. are not recommended, and we assume no responsibility for any failure caused by these applications when used. We will review the acceptability of the abovementioned applications, if you agree not to require a specific quality for a specific application. Please contact us for consultation.

Mitsubishi Electric's global FA network delivers reliable technologies and security around the world.

■ Production base
 ● Development center
 ● Global FA Center
 ▲ Mechatronics showroom
 ● Mitsubishi Electric sales office

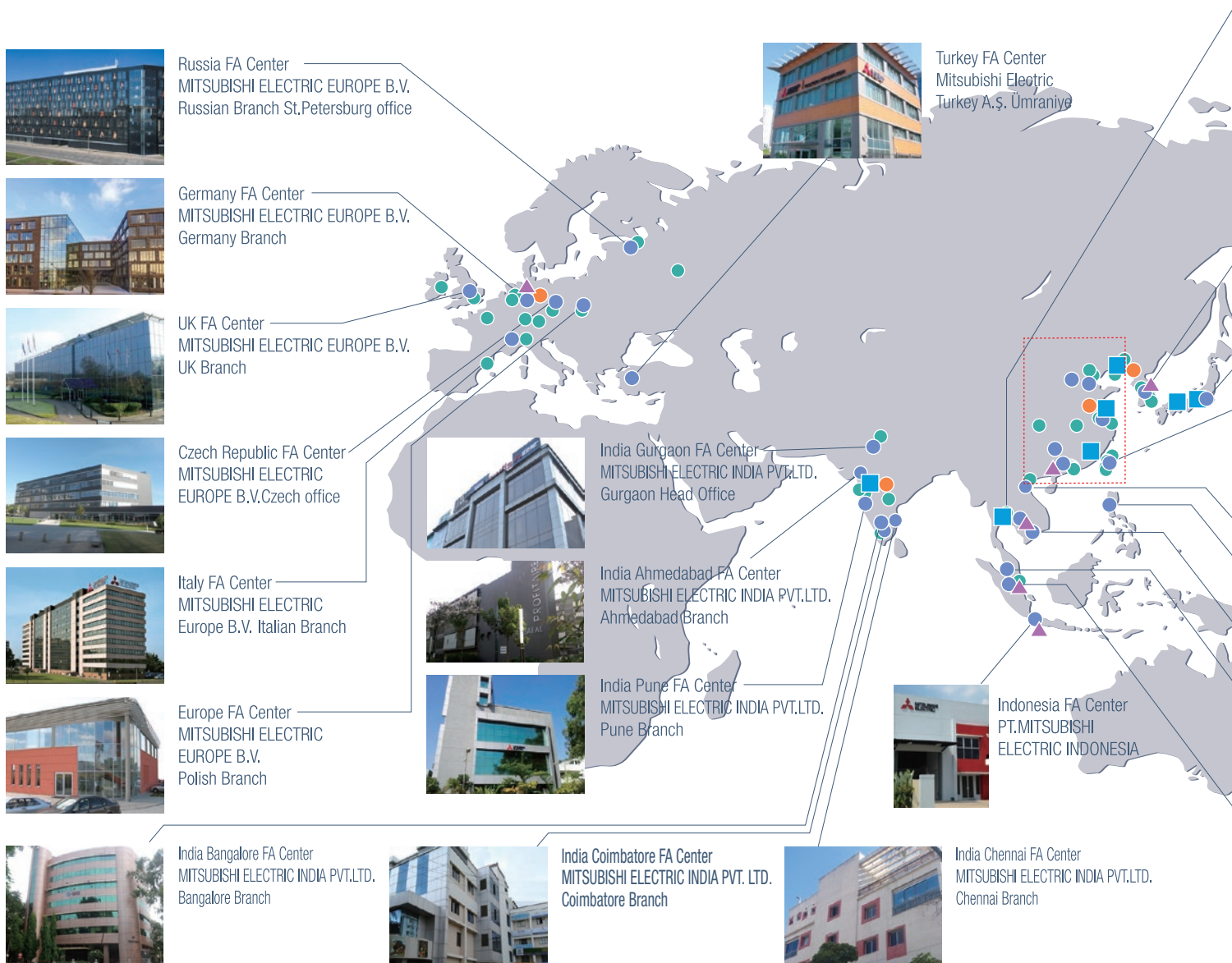

Production bases Under the lead of Nagoya Works, we form a powerful network to optimize our manufacturing processes.

Domestic bases

Nagoya Works



Shinshiro Factory
Kani Factory

Production bases overseas

MDI Mitsubishi Electric Dalian Industrial Products Co., Ltd.



MEI Mitsubishi Electric India Pvt.



MEAMC Mitsubishi Electric Automation Manufacturing (Changshu) Co., Ltd.

MEATH Mitsubishi Electric Automation (Thailand) Co., Ltd.

Thailand FA Center
 MITSUBISHI ELECTRIC FACTORY
 AUTOMATION (THAILAND) CO.,LTD

Korea FA Center
 MITSUBISHI ELECTRIC
 AUTOMATION KOREA CO.,LTD.

MITSUBISHI ELECTRIC CORPORATION
 Factory Automation Systems Group

Taichung FA Center
 MITSUBISHI ELECTRIC
 TAIWAN CO.,LTD

Taipei FA Center
 SETSUYO ENTERPRISE CO.,LTD

Philippines FA Center
 MELCO FACTORY AUTOMATION
 PHILIPPINES INC.

Hanoi FA center
 Mitsubishi Electric
 Vietnam
 Company Limited
 Hanoi Branch

Malaysia FA Center

Ho Chi Minh FA Center
 MITSUBISHI ELECTRIC
 VIETNAM COMPANY
 LIMITED

ASEAN FA Center
 MITSUBISHI ELECTRIC
 ASIA PTE.LTD.

North America FA Center
 MITSUBISHI ELECTRIC
 AUTOMATION,INC.

Mexico Monterrey FA Center
 Monterrey Office, Mitsubishi
 Electric Automation, Inc.

Mexico FA Center
 Querétaro Office, Mitsubishi
 Electric Automation, Inc.

Mexico City FA Center
 Mexico FA Center
 Mexico Branch, Mitsubishi
 Electric Automation, Inc.

Brazil FA Center
 Mitsubishi Electric do Brasil
 Comércio e Serviços Ltda.

Brazil Votorantim FA Center
 MELCO CNC do Brasil
 Comércio e Serviços S.A.

Service bases are established around the world to provide the same services as in Japan globally. Overseas bases are opening one after another to support our customers' business expansion.

Area	Our overseas	FA centers
EMEA	39	7
China	25	4
Asia	49	16
Americas	19	6
Total	132	33

-As of March 2021

China

Beijing FA Center
 MITSUBISHI ELECTR
 AUTOMATION (CHINA)

Tianjin FA Center
 MITSUBISHI ELECTR
 AUTOMATION (CHINA)

Guangzhou FA Center
 MITSUBISHI ELECTRIC
 AUTOMATION (CHINA)LTD.

Shanghai FA Center
 MITSUBISHI ELECTRIC
 AUTOMATION (CHINA) LTD.

This solution solves customers' issues and concerns by enabling visualization and analysis that lead to improvements and increase availability at production sites.

Utilizing our FA and IT technologies and collaborating with e-Factory Alliance partners, we reduce the total cost across the entire supply chain and engineering chain, and support the improvement initiatives and one-step-ahead manufacturing of our customers.



FA integrated solutions reduce total cost

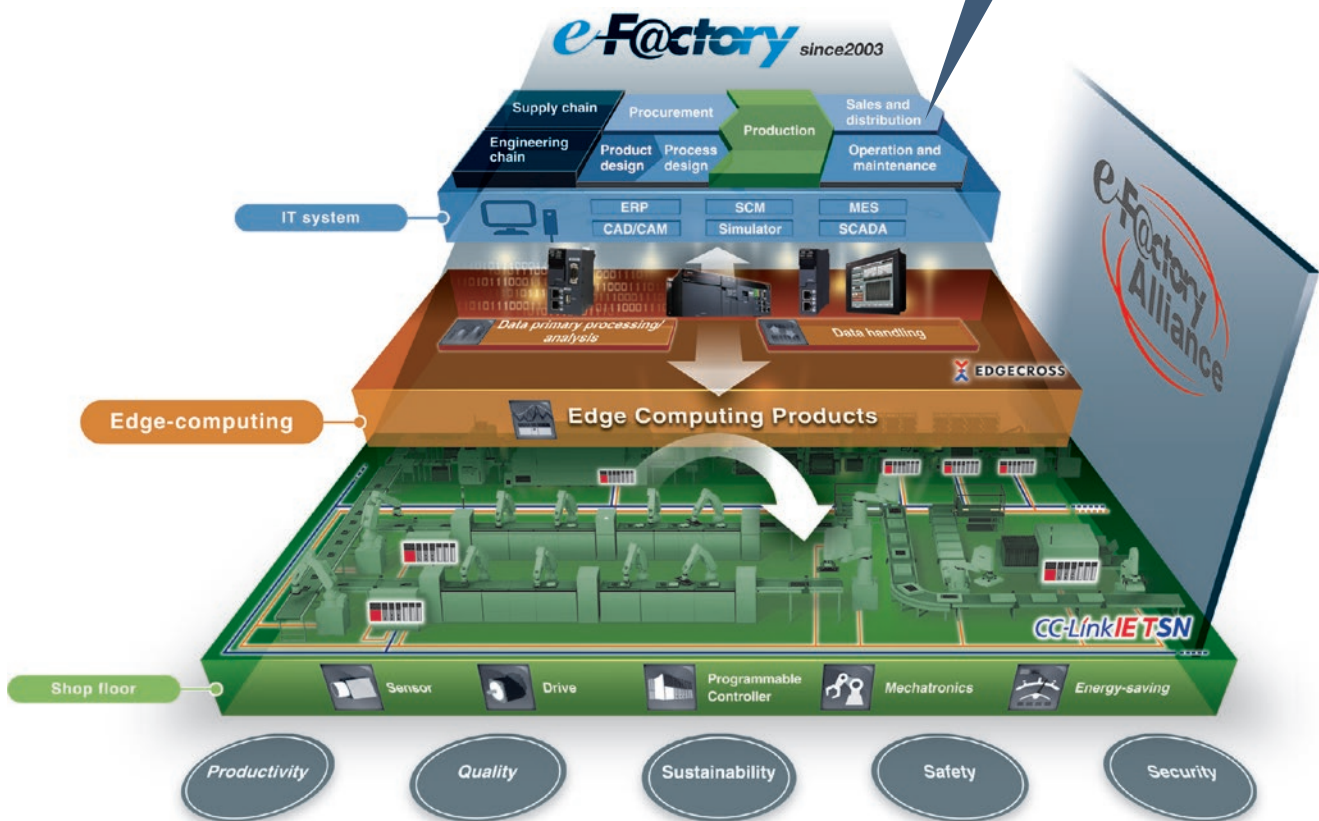
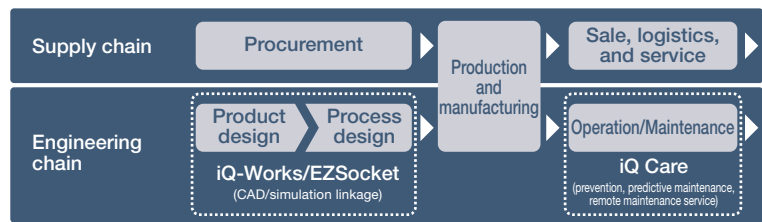

Overall production information is captured in addition to energy information, enabling the realization of efficient production and energy use (energy savings).

•Trademarks

PROFIBUS, PROFINET, and PROFIsafe are either trademarks or registered trademarks of PROFIBUS & PROFINET International. DeviceNet, EtherNet/IP, and CIP safety are either trademarks or registered trademarks of ODVA. EtherCAT is a trademark of Beckhoff Automation GmbH. Safety over EtherCAT is a trademark of Beckhoff Automation GmbH. MODBUS is a registered trademark of SCHNEIDER ELECTRIC USA, INC. BACnet is a registered trademark of the American Society of Heating, Refrigerating and Air-Conditioning Engineers (ASHRAE).

CC-Link IE TSN and CC-Link IE Field Network Basic are registered trademarks of CC-Link Partner Association. QR Code registered trademark of DENSO WAVE INCORPORATED. App Store is a service mark of Apple Inc. Google Play and the Google Play logo are trademarks of Google LLC. Other company and product names herein are the trademarks and registered trademarks of their respective owners.

⚠ Safety Warning

To ensure proper use of the products listed in this catalog, please be sure to read the instruction manual prior to use.

YOUR SOLUTION PARTNER

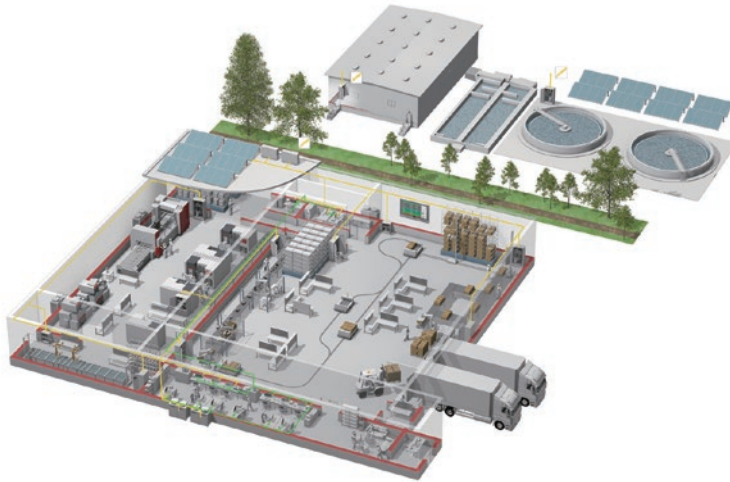

Mitsubishi Electric offers a wide range of automation equipment from PLCs and HMIs to CNC and EDM machines.

A NAME TO TRUST

Since its beginnings in 1870, some 45 companies use the Mitsubishi name, covering a spectrum of finance, commerce and industry.

The Mitsubishi brand name is recognized around the world as a symbol of premium quality.

Mitsubishi Electric Corporation, established in 1921, is active in space development, transportation, semi-conductors, energy systems, communications and information processing, audio visual equipment and home electronics, building and energy management and automation systems, and has 183 factories, laboratories and offices worldwide in over 140 countries.

This is why you can rely on Mitsubishi Electric automation solution - because we know first hand about the need for reliable, efficient, easy-to-use automation and control in our own factories.

As one of the world's leading companies with a global turnover of over 4 trillion Yen (over \$40 billion), employing over 146,000 people, Mitsubishi Electric has the resource and the commitment to deliver the ultimate in service and support as well as the best products.

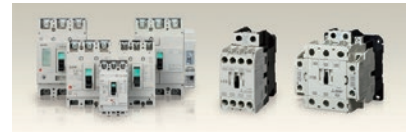

Low-voltage Power Distribution Products



Transformers, Med-voltage Distribution Products



Power Monitoring and Energy Saving Products



Power (UPS) and Environmental Products



Compact and Modular Controllers



Servos, Motors and Inverters



Visualization: HMIs



Edge Computing Products



Numerical Control (NC)



Collaborative and Industrial Robots



Processing machines: EDM, Lasers

* Not all products are available in all countries.

mitsubishi electric corporation

HEAD OFFICE: TOKYO BLDG., 2-7-3, MARUNOUCHI, CHIYODA-KU, TOKYO 100-8310, JAPAN
